



ASSORTMENTS



PART 12

3rd Edition



ISO/TS 16949:2002 certified supplier

Contents

From Part 2 Catalogue		Page			Page			Page
802017	Alt. Mounting Parts Repl. Bo ..	9	802025	Special Bearings - Eur. Alt. ...	20	803026	Starter Parts Repl. Lu	36
802019	Alt. Parts Repl. Bo	8	802002	Special Bearings - Jap. Alt. ...	19	803028	Starter Parts Repl. Mi	38
802001	Alt. Parts Repl. DR Eur.	9	From Part 3 Catalogue			803030	Starter Parts Repl. ND I	40
802020	Alt. Parts Repl. DR US	10	803018	Brushes 12 V. Repl. Bo	28	803031	Starter Parts Repl. ND II	40
802021	Alt. Parts Repl. DR US	10	803017	Brushes 24 V. Repl. Bo	29	803034	Starter Parts Repl. PR / Va ..	42
802030	Alt. Parts Repl. Hi	11	803016	Brushes Repl. DR US	31	VARIOUS:		
802015	Alt. Parts Repl. La / MM	12	803037	Brushes Repl. Du	32	803041	Brush Springs	45
802016	Alt. Parts Repl. Lu	12	803023	Brushes Repl. Hi	34	803042	Bushings & Bearings for Jap. Starters	44
802008	Alt. Parts Repl. Mi	13	803021	Brushes Repl. La / MM	33	803005	Brushes for DC-Motors	44
802013	Alt. Parts Repl. Mo	14	803024	Brushes Repl. Lu	35	803038	Brushes for Jap. Starters	43
802004	Alt. Parts Repl. ND	14	803027	Brushes Repl. Mi	37	803040	Grommets	45
802003	Alt. Parts Repl. ND	15	803029	Brushes Repl. ND	38	803007	O-Rings for Alt. & Starters ...	46
802014	Alt. Parts Repl. PR / VA	16	803032	Brushes Repl. PR / Va	41	803039	Oil Seals	46
802022	Alt. Parts Repl. SEV	16	803012	Bushings Repl. Bo	29	803035	Solenoid Parts for Bo/DR Eur./FE/MM	42
802033	Free Wheel Pulleys Repl. Bo .	8	803014	Bushings Repl. DR US	30	803036	Solenoid Parts for Du/Hi/Mi/PR	43
802007	VP Parts Repl. Hi	11	803019	Bushings Repl. Du	32	803013	Special Bearings	47
802009	VP Parts Repl. Mi	13	803002	Bushings Repl. Hi	34	803006	Terminal Leads	47
802005	VP Parts Repl. ND	15	803020	Bushings Repl. La / MM	33	From Part 4 Catalogue		
VARIOUS:			803025	Bushings Repl. Lu	36	804017	ABS Connectors & Tools	51
802034	Bearing Caps	22	803003	Bushings Repl. Mi	37	804074	Battery Terminals I	64
802010	Bearing Tolerance Rings	22	803001	Bushings Repl. ND	39	804089	Battery Terminals II	64
802031	Brushes	18	803033	Bushings Repl. PR / Va	41	804072	Bits	85
802027	Brushes - Jap. Alternators ..	19	803009	Gear Parts Repl. Bo	27	804073	Butt Splices	58
802011	Diodes - Alternators	17	803010	Gear Reduction - Brushes & Holders Repl. Bo ...	28	804088	Button & High Voltage Batteries	85
802024	IC Regulator for HI / Mi / ND	17	803008	Gear Wheels Repl. Bo	27	804021	Cable Clips I	77
802035	Needle Bearings	21	803004	Solenoid Parts Repl. ND	39	804070	Cable Clips II	77
802028	Nuts & Keys - Alternators ...	23	803011	Starter Parts for FKB Repl. Bo	30	804054	Cable Joints	57
802029	Oil Seals for Alternators	21	803015	Starter Parts Repl. DR US ...	31	804108	Cable Glands II	65
802032	Slip Rings	18	803022	Starter Parts Repl. Hi	35	804091	Cable Glands PG I	65
802026	Small Bearings - Alternators	20						
802023	Spacers for Pulleys - Alt.	23						

Care is taken to ensure the accuracy of descriptions and applications of each item, but **CARGO** assumes no responsibility for possible errors. O.E.M. names and numbers are used for reference purposes only.
Printed in Denmark. Copyright © 2006 Holger Christiansen A/S

Contents

	Page		Page		Page
804084	Cable Markers	75	804036	Fuses - Continental & Glass ..	66
804024	Cable Ties	78	804099	Fuses - Maxi	69
804075	Connectors I (Superseal)	60	804106	Fuses - Maxi Blade	68
804080	Connectors II	61	804086	Fuses - Mega	71
804081	Connectors III	61	804094	Fuses - Midi	71
804085	Cord End Terminals	59	804096	Fuses - Mini	67
804061	Crimp & Solder Terminals	58	804052	Fuses - Pal type I	69
804055	Crimp Seal Terminals	55	804076	Fuses - Pal type II	70
804014	Crimp Terminals - Insulated I ..	53	804032	Fuses - Special type	70
804095	Crimp Terminals - Insulated II .	54	804102	Fuses - Strip (Closed) Type	73
804013	Crimp Terminals - Non-insulated	56	804090	Fuses - Strip Type	72
804093	Crimp Terminals w/ Tools - insulated	54	804012	Insulator & Multiple Connectors	59
804015	Crimp Terminals - Ring type - Insulated	54	804019	Insulator Washers	82
804049	Crimp Terminals - Blue	52	804068	Lock Rings	83
804048	Crimp Terminals - Red	51	804037	Machine Screws & Nuts	81
804050	Crimp Terminals - Yellow	52	804040	Mini Clamps	79
804078	Display w/ Single Core Cables	74	804092	Pin terminals - Non Insulated I	56
804077	Display w/ Thermoshrinking Pipes ..	75	804103	Pin terminals - Non Insulated II	57
804101	Display w/ Thermoshrinking Pipes w/ glue	76	804082	Powr Bloks™ I	63
210574	Drills (HSS)	86	804083	Powr Bloks™ II	63
804100	DT-Connectors	60	804016	Power Connectors & Terminals	62
804107	DTM-Connectors	62	804065	Protecting Caps	83
804033	Fuse Holders	73	804064	Protecting Plugs	84
804405	Fuse Holders - ATO Blade ..	74	804041	PVC Caps	84
804097	Fuses - ATO / Mini / Maxi	67	804022	Rubber Grommets & Blankings	78
804098	Fuses - ATO / Mini / PAL	68	804020	Sealing Rings I	82
804008	Fuses - Blade type	66	804056	Solder Grip Terminals	55
804104	Fuses - Compact	72	804029	Special Bolts & Screws	80
			804028	Special Hex Nuts	81
			804069	Tapping Screws I	79
			804079	Tapping Screws II	80
804062	Thermoshrinking Pipes	76			
From Part 6 Catalogue					
806004	Adjustment Shims 6.80 mm.	93			
806005	Adjustment Shims 7.25 mm.	94			
806025	Adjustment Shims 8.50 mm.	94			
806026	Adjustment Shims 9.40 mm.	95			
806006	Adjustment Shims 9.80 mm.	95			
806007	Adjustment Shims 11.50 mm.	96			
806017	Angle Joints & Fork Heads	98			
806022	Cotter Pins, Angles & Fork Joints	98			
806009	Flame Arresters Eur. Appl. ..	92			
806010	Flame Arresters Jap. Appl. ..	92			
806001	Injec. Pipe Holders & Nut Sets	101			
806019	Injector Washers & Overflow .	99			
806023	Glow Plugs I	102			
806027	Glow Plugs II	102			
806030	Glow Plugs III	103			
806020	Hollow Screws & Hose Nipp.	100			
806016	Hollow Screws & Sealing Rings	96			
806012	Nozzle Holder Parts	91			
806018	Pipe Nipples & Brass Olives	101			
806021	Pipe & Hose Nipples	100			
806015	Ring Nipples & Hose Sleeves .	99			
806011	Thermal Washers	93			
806014	Throttle Shafts Jap. Appl.	91			
806003	Throttle Shafts Repl. BO I	89			
806029	Throttle Shafts Repl. BO II ...	89			
806008	Throttle Shafts Repl. CAV	90			
806002	Sealing Rings II	97			

ABBREVIATIONS:

A=Assortment, AC=Air Condition, Alu=Aluminium, Amp.=Ampere, AT=Automatic Transmission, Cat.=Catalyzer, Ch.=Chassis, Cyl.=Cylinder, CW=Clockwise rotation, Eng.=Engine, Eur.=European application, FWD.=Four Wheel Drive, H=Height, HD=Heavy Duty construction, I.D.=Inner Diameter, kW.=Kilowatt, L=Length, LHD=Left Hand Drive, LL.=Lead Length, M=Minimum supply, MT=Manual Transmission, Mtr.=Metre, O.D.=Outer Diameter, O.E.=Original Equipment, PS=Power Steering, RHD=Right Hand Drive, Th.=Thickness, V.=Volt, W.=With, Wo=Without, W.=Width, []=Eng. no.

Contents

	Page	<u>From Part 10 Catalogue</u>	Page		Page
806028	97	810001	129	815005	141
806024	90	810002	129	815006	141
From Part 7 Catalogue		810006	130	815007	142
807002	107	810007	130	815008	142
From Part 8 Catalogue		From Part 11 Catalogue		815009	143
808001	116	811001	133	815010	143
808002	111	811002	133	815011	144
808016	117	811003	134	815012	144
808004	113	811004	134	815013	145
808005	113	811005	135	815014	145
808006	114	From Part 15 Catalogue		815015	146
808007	114	815031	154	815016	146
808015	112	815030	153	815017	147
808008	115	815034	155	815018	147
808009	115	815032	154	815019	148
808010	118	815033	155	815020	148
808003	111	815021	149	815027	152
808011	117	815022	149	815026	151
808012	116	815023	150	815029	153
808013	118	815024	150	Assortment Boxes and Inserts 5	
808014	112	815025	151	Index 157	
From Part 9 Catalogue		815028	152		
809001	121	815001	139		
809002	122	815002	139		
809008	121	815003	140		
809003	122	815004	140		
809005	123				
809006	124				
809009	123				
809007	124				
809004	125				

Assortment Boxes and Inserts



200663 Std pkg 6
 Profi Service Case, empty.
 Can be divided using inserts.
 Dim.: 340 x 265 x 57 mm.
 Polypropylene (Unbreakable).

INSERTS FOR ASSORTMENT BOXES Polypropylene (Unbreakable)

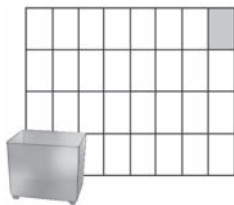

200664 Std pkg 96
 Dim.: 55 x 40 x 45 mm.

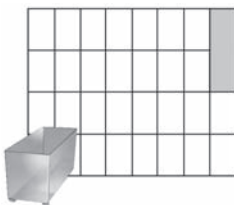

200665 Std pkg 48
 Dim.: 110 x 40 x 45 mm.

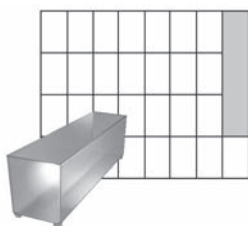

200666 Std pkg 30
 Dim.: 165 x 40 x 45 mm.



200667 Std pkg 24
 Dim.: 220 x 40 x 45 mm.

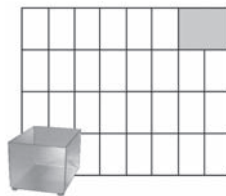

200668 Std pkg 48
 Dim.: 55 x 80 x 45 mm.

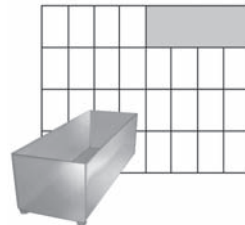

200669 Std pkg 24
 Dim.: 55 x 160 x 45 mm.



200670 Std pkg 15
 Dim.: 55 x 240 x 45 mm.

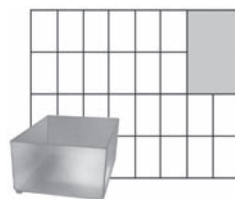

200671 Std pkg 24
 Dim.: 110 x 80 x 45 mm.

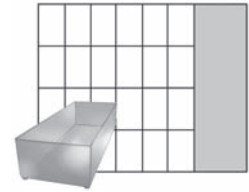

200672 Std pkg 12
 Dim.: 220 x 80 x 45 mm.



200673 Std pkg 12
 Dim.: 110 x 160 x 45 mm.



200676
 Display for 4 Profi Service Cases.
 Dim.: 330 x 360 x 200 mm.



200693
 Display for 4 Profi service cases.
 Dim.: 313 x 373 x 265 mm.
 Can be assembled horizontally or vertically.

Notes

A large, empty rectangular area with rounded corners, intended for writing notes.



ASSORTMENTS

PART 2

Alternator Parts Replacing BOSCH

802019

 133373 Qty. 2 M8 x 51.5. B+terminal.	 133374 Qty. 2 M8 x 48. B+terminal.	 131294 Qty. 10 3 Amp. 1000 V.	 133401 Qty. 2 Repl. 1124 304 007. O.D. 32 mm, Sh. 17 mm, L. 22.3 mm.	 133402 Qty. 2 Repl. 1124 303 001. O.D. 28 mm, Sh. 17 mm, L. 22.1 mm.	 135172 Qty. 1 Serv. 0120 465... 485... O.D. 14 mm, L. 52.1 mm. Shaft 7.0 mm.	 BX182 2 Qty. 5 Repl. 1127 014 009. 5 x 10 x 17 mm. 12 V.	 BX185 2 Qty. 5 Repl. 1127 014 011. 5 x 8 x 15 mm. 12 V.
 BX198 2 Qty. 5 Repl. 1127 014 014. 5 x 10 x 17 mm. 12 / 24 V.	 BX202 2 Qty. 5 Repl. 1127 014 017. 5 x 8 x 19 mm. 24 V.	 BX204 2 Qty. 5 Repl. 1127 014 018. 5 x 8 x 19 mm. 12 V.	 BX213 2 Qty. 5 Repl. 1127 014 028. 4 x 6 x 17.5 mm. 12 V.	 131828 Qty. 2 Repl. 1120 591 082. I.D. 32 mm, O.D. 35 mm L. 15 mm.	 132769 Qty. 2 Repl. 1120 591 075. I.D. 34 mm, O.D. 35 mm L. 42 mm.		
 135237 Qty. 2 Repl. 1120 591 076. I.D. 40 mm, O.D. 43 mm L. 16.6 mm.	 134552 Qty. 5 Repl. 1120 150 001. 26 x 23.5 x 0.3 mm. For bearing 6200 series.	 140438 Qty. 5 Repl. 1120 150 000. 29.7 x 22.5 x 0.3 mm. For bearing 6200 series.	 140439 Qty. 5 31.7 x 26.5 x 0.4 mm. For bearing 6201 series.	 140524 Qty. 2 Serv. 0120 488 000, -001, -002, -003. 28 x 35 x 13 mm.	 134557 Qty. 10 Repl. 1124 682 000.		
 134558 Qty. 10 Repl. 1124 682 002.	 134555 Qty. 10 Repl. 1121 030 000.	 132804 Qty. 2 Terminal plug. 3 pin.	 190259 Qty. 3 Repl. 1194 485 402. 3 pin. Terminal: Cargo 190252	 190762 Qty. 3 Repl. 1194 485 404. 4 pin. Terminal: Cargo 190252	 135060 Qty. 10 11.3 x 18.4 x 3.5 mm. Felt.	 135174 Qty. 5 Repl. 1124 652 000. Serv. 0120 400 . . .	 191292 Qty. 10 Repl. 1123 429 102. M5 x 110 mm.

Free Wheel Pulleys Replacing BOSCH

802033

 230083 Qty. 1 Repl. 1126 601 566, F-225653.5. Serv. 0123 320 055, 0123 515 003. O.D. 56 mm. Bore 17 m. W. 36.5 mm. 5 grooves. W/ Free Wheel.	See Combi Tools Part 4		 138807 Qty. 1 Repl. 1126 601 572, F-225643.5. Serv. 0123 320 029, -047, Mercedes. O.D. 55.5 mm. Bore 17 m. W. 33.5 mm. 6 grooves. W/ Free Wheel.
 138203 Qty. 1 Repl. 1126 601 559, F-22684.5. Serv. 0123 310 035, 0123 320 032. O.D. 56 mm. Bore 17 m. W. 42.4 mm. 6 grooves. W/ Free Wheel.	 138282 Qty. 1 Repl. 1126 601 557, F-226556.5. Serv. 0123 320 033, Seat, Skoda, VW. O.D. 56 mm. Bore 17 m. W. 37.2 mm. 5 grooves. W/ Free Wheel.	 139281 Qty. 1 Repl. 1126 601 565, F-225355.5. Serv. 0123 310 049, 0123 320 038. O.D. 49.5 mm. Bore 17 m. W. 40.65 mm. 6 grooves. W/ Free Wheel.	 230293 Qty. 1 Repl. F00M991 002, F-227628.5. Serv. 0124 315 001, -013, 0124 325 001. O.D. 56 mm. Bore 17 m. W. 42.45 mm. 6 grooves. W/ Free Wheel.
 230292 Qty. 1 Repl. 1126 601 597, F-228824.1. Serv. 0123 320 051, -65, 0123 510 082. O.D. 50 mm. Bore 17 m. W. 40.5 mm. 6 grooves. W/ Free Wheel.	 138073 Qty. 1 Repl. 1126 601 568, F-225644.5. Serv. 0123 320 041, -046, -062. O.D. 55.7 mm. Bore 17 m. W. 37.7 mm. 6 grooves. W/ Free Wheel.		

802017 Alternator Mounting Parts Replacing BOSCH

















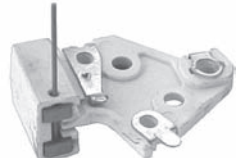

 132397 Qty. 2 Repl. 1120 323 000. 15 x 23/28 x 20 mm.	 132398 Qty. 2 Repl. 1120 321 000. 15 x 20.8/26.5 x 8.2 mm.	 131820 Qty. 2 Serv. 0120 469 538, -539, -593, -594, -595, -617. BMW 45, 55, 65 Amp. alternators. Thin ear, 25 mm.	 131821 Qty. 2 Serv. 0120 489 036, -038, -039, -045, -046, -533. BMW 45, 55, 65 Amp. alternators. Thick ear, 51 mm.	 133641 Qty. 2 Serv. BMW 85-90 Amp. alternators. Thick ear, 56 mm.		
 131823 Qty. 2 Serv. Audi, VW. 75/90 Amp. alternators. B+ insulator.	 132081 Qty. 2 Serv. BMW. 45/65 Amp. alternators. B+ insulator.	 131824 Qty. 2 Serv. BMW. 80/90 Amp. alternators. B+ and D+ insulator.	 131825 Qty. 2 Serv. BMW. 80/90 Amp. alternator. B+ and D+ insulator.	 132767 Qty. 2 B+ and D+ insulator.		
 132768 Qty. 2 B+ insulator.	 132806 Qty. 2 B+ and D+ insulator.	 132807 Qty. 2 B+ and D+ insulator.	 134541 Qty. 2 Repl. 1127 011 054 B+ insulator only: Cargo 131823.	 132324 Qty. 10 Repl. 1900 023 008. 4 x 6.5 x 16 mm.		
 133785 Qty. 10 Repl. 1900 023 004. 3 x 3.7 x 10 mm.	 134774 Qty. 10 8 x 13.05 x 20 mm. Steel. Mounting bushing, D.E.	 134775 Qty. 10 8 x 14 x 20 mm. Mounting bushing, D.E. Oversize.	 134964 Qty. 5 10 x 15 x 18 mm. Mounting bushing, D.E.	 135061 Qty. 5 11.5 x 14 x 50 mm. Mounting bushing, D.E.	 135211 Qty. 10 8.2 x 13.6 x 20 mm. Mounting bushing, D.E.	 135216 Qty. 5 8.4 x 14.0/20.0 x 13.0 mm. Mounting bushing, D.E.

802001 Alternator Parts Replacing DELCO EUR

 130668 Qty. 5 Repl. 1116380. Type 100 - 205 serie. 12 V.	 130674 Qty. 5 Repl. DR 3901. Serv. Opel, Vauxhall. Black case.	 130843 Qty. 5 Repl. 92100510. Serv. Opel, Vauxhall. O.D. 22.5 mm, Shaft 12 mm, L. 24.4 mm.	 132346 Qty. 10 Repl. 1915172. Rotor shaft nut.
 132581 Qty. 10 5 x 9/14 x 4 mm. Insulator bushing.	 132582 Qty. 10 6.35 x 14.73/15.08 x 6mm Insulator bushing.	 132611 Qty. 5 Repl. DR 3901, 3472312. Serv. Opel, Vauxhall. Orange case.	 133198 Qty. 10 M6 x 50. B+ terminal.
 133497 Qty. 5 Repl. 3493057. Insulator.	 134140 Qty. 5 B+ to regulator. Old style. Connector.	 134870 Qty. 10 Repl. 3472506. Serv. 3472..., RX103F 2. Brush spring.	 RX103F 2 Qty. 10 Repl. DR702. Serv. Opel, Vauxhall. 5 x 8 x 13.2 mm. 12 V.
 B140088P Qty. 5 62032Z/C3. 17 x 40 x 12 mm.	 140115 Qty. 10 Repl. 3472455. Serv. Opel, Vauxhall. 11.5 x 17.5 x 16.5 mm.	 RX103E 2 Qty. 5 Repl. 7982543. 5 x 8 x 13.2 mm. 12 V.	 RX103F 2 Qty. 10 Repl. DR702. Serv. Opel, Vauxhall. 5 x 8 x 13.2 mm. 12 V.













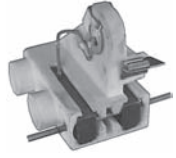



Alternator Parts Replacing DELCO US

802020









 132346 Qty. 5 Repl. 1915172. Serv. 10 DN, 10 SI etc. Rotor shaft nut.	 140120 Qty. 5 Repl. 9436831. Serv. 10 SI, 12 SI. 17 x 23.8 x 17.4 mm.	 131418 Qty. 2 Repl. 1984459. Serv. 10 SI, 12 SI.	 133867 Qty. 2 Repl. 1987324. Serv. 20 SI 300. Orange case.	 130561 Qty. 2 Serv. 10 DN, 10 SI. Long leads. O.D. 30 mm, Shaft 18 mm, L. 27.8 mm			
 132295 Qty. 2 Serv. 15 SI. O.D. 30 mm. Shaft 17 mm. L. 28.2 mm.	 130549 Qty. 1 Repl. 801466. Serv. 10 SI. Complete w/ brushes. 12 V.	 130558 Qty. 1 Repl. 1852002. Serv. 27 SI. Complete w/ brushes. 12 V.	 131476 Qty. 1 Repl. 1894559. Serv. 10 SI, 1102918, 1102922. Complete w/ brushes. 12 V.				
 140134 Qty. 5 Repl. 1942360. 5 x 8 x 12.5 mm. LL. 17 mm. 12 V.	 140135 Qty. 5 Repl. 1876873. 5 x 8 x 18.5 mm. LL. 22 mm. 12 V.	 130668 Qty. 2 Repl. 1116380. Serv. 10 SI, 12 SI, 15 SI, 17 SI, 27 SI. Type 100 - 205 serie. 12 V.					
 133945 Qty. 2 Repl. 1959991. O.D. 22.23 mm, Bore 17 mm, Th. 5.0 mm.	 133946 Qty. 2 Repl. 1978064. O.D. 25.5 mm, Bore 17 mm, Th. 10.0 mm.	 133948 Qty. 2 Repl. 1963139. O.D. 22.23 mm, Bore 17 mm, Th. 10.0 mm.	 133949 Qty. 2 Repl. 1984476. O.D. 25.4 mm, Bore 17 mm, Th. 7.0 mm.	 131504 Qty. 5 Repl. 1846900. Battery terminal kit. (24G 3/16, 7/32).	 135005 Qty. 5 Repl. 1975471. Battery terminal kit. (Metric).	 132581 Qty. 10 5.0 x 7.3 - 14.3 x 4 mm. Insulator bushing.	 132582 Qty. 10 6.35 x 14.73 - 15.08 x 6 mm. Insulator bushing.

Alternator Parts - CS 121, 130, 144 Repl. DELCO US











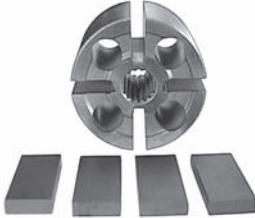







802021

 134526 Qty. 2 Serv. CS 121, CS 130, CS 144. Repair harness.	 132346 Qty. 5 Repl. 1915172. Serv. 10 DN, 10 SI etc. Rotor shaft nut.	 133924 Qty. 2 Serv. CS 121, 130. O.D. 26.1/26.4 mm, Shaft 13.2 mm. L. 23.8 mm.	 131915 Qty. 2 Repl. 1989651. Complete W/ brushes. 12 V.	 131916 Qty. 2 Repl. 1989702. Complete W/ brushes. 12 V.	
 140598 Qty. 5 Serv. CS 121, 130. 5 x 8 x 22.5 mm. 12 V.	 133945 Qty. 2 Repl. 1959991. O.D. 22.23 mm, Bore 17 mm, Th. 5.0 mm.	 133946 Qty. 2 Repl. 1978064. O.D. 25.5 mm, Bore 17 mm, Th. 10.0 mm.	 133947 Qty. 2 Serv. CS 130. O.D. 25.5 mm, Bore 17 mm, Th. 3.0 mm.	 133948 Qty. 2 Repl. 1963139. O.D. 22.23 mm, Bore 17 mm, Th. 10.0 mm.	 140120 Qty. 5 Repl. 9436831. Serv. 10 SI, 12 SI. 17 x 23.8 x 17.4 mm.
 131924 Qty. 1 Serv. CS 130 series. Cover, stator leads.	 132047 Qty. 2 Serv. CS 121, CS 130 series. Cover for rectifier: Cargo 131880.	 133928 Qty. 5 Serv. CS 121, 130. Terminal kit. M5-0.8INT., M6-1.0EXT.	 133935 Qty. 5 Serv. CS 130. B+ terminal kit.	 133038 Qty. 5 Repl. 10469356. 26 x 28 x 11.3 mm. Bearing Cap.	 134656 Qty. 3 Serv. CS 130. Round to square terminal adaptor kit.
 133929 Qty. 1 Serv. CS 121. Cover, stator leads.	 134077 Qty. 10 Serv. CS 121, 130. M4-0.7 x 22 mm. Screw.	 191307 Qty. 20 Serv. CS 121, 130. M5-0.8. Hex nut.	 132581 Qty. 10 5.0 x 7.3 - 14.3 x 4 mm. Insulator bushing.	 132582 Qty. 10 6.35 x 14.73 - 15.08 x 6 mm. Insulator bushing.	

802030 Alternator Parts - Repair Kits Repl. HITACHI

 <p>137841 Qty. 1 Repl. L170G-1315. Serv. LR170-420. 12 V.</p>	 <p>131287 Qty. 2 Repl. TR1Z-64. Serv. Cargo 132431, -432, 133543, -544. 12 V. Repair circuit w/ terminals E-F-L-R-S-B.</p>	 <p>132660 Qty. 5 Repl. 2084-0641. Serv. LR225-65, LR235-402. 25 x 2 mm. O-ring.</p>
 <p>135037 Qty. 1 Repl. L160-23202, 23230-57J03. Copper heat sink. O.D. 118 mm, 6 diodes, w/ diode trio.</p>	 <p>140380 Qty. 5 Repl. L150-23251. 5 x 7 x 21 mm. 12 V.</p>	 <p>132661 Qty. 5 Repl. L150-1922, 14658-44G00. Serv. LR235-402. Alternator w/ vacuum pumps 15 x 32 x 7.5 mm. Twin oil seal S.R.E.</p>
<p>140434 Qty. 2 Repl. 6202 NCD, 23129-05E06. 15/35 x 13 mm. W/ snap ring.</p>	 <p>140093 Qty. 2 6303 2RS1/C3 17 / 47 x 14 mm. W/ snap ring.</p>	

802007 Vacuum Pump Parts Replacing HITACHI

 <p>139964 Qty. 1 Repl. VP25-19301, -29301. O.D. 49.2 mm, W. 25 mm, 16 splines. Rotor.</p>	 <p>134394 Qty. 1 Repl. VP50-1930, 14651-W2500. Serv. LR140-402, -408, -415B, -422T. O.D. 52.2 mm, W. 39 mm, 16 splines. Rotor. W/ vane set 133279.</p>	 <p>133277 Qty. 2 Repl. VP25-19101. 5 x 13.8 x 25 mm. Rotor vane set.</p>	 <p>133279 Qty. 2 Repl. VP50-1910. 5 x 15.2 x 39 mm. Rotor vane set.</p>	 <p>136873 Qty. 1 Serv. LR170-411B. M16-1.5/M18-1.5. Valve</p>	 <p>135453 Qty. 1 Repl. VP25-59623. For M18 hollow screw, 5/10 mm. hose I.D.</p>
 <p>132297 Qty. 4 Repl. L150M-29221, 14658-36W00. Serv. LR225-65. Alternators w/ vacuum pump. 15 x 32 x 7 mm. Single oil seal S.R.E.</p>	 <p>132661 Qty. 4 Repl. L150-1922, 14658-44G00. Serv. LR235-402. Alternators w/ vacuum pump. 15 x 32 x 7.5 mm. Twin oil seal S.R.E.</p>	 <p>132659 Qty. 5 Repl. 2084-0631. Serv. LR225-65, LR235-402. 61 x 2 mm. O-ring.</p>			
 <p>132660 Qty. 5 Repl. 2084-0641 Serv. LR225-65, LR235-402. 25 x 2 mm. O-ring.</p>	 <p>134490 Qty. 5 Repl. VP50-1915, 14688-W2500. 62 x 2 mm. O-ring.</p>	 <p>080256 Qty. 2 M16-1.5. Hollow screw.</p>	 <p>080253 Qty. 2 M10-1.5. Hollow screw.</p>		
 <p>135129 Qty. 1 Repl. VP25-9947, 14675-60L00. Serv. LR160-417. Valve set.</p>	 <p>135130 Qty. 1 Repl. VP25-49471, 14675-R8800. Serv. LR140-130P, -410F, -411F, -421T, -423F. Valve set.</p>	 <p>135131 Qty. 1 Repl. VP25-39471. Serv. LR140-415B. Valve set.</p>	 <p>134290 Qty. 2 M12-1.5. Screw plug.</p>	 <p>190806 Qty. 10 10 x 16 x 1 mm. Copper.</p>	 <p>190818 Qty. 10 16 x 22 x 1.5 mm. Copper.</p>

Alternator Parts Repl. LADA / MAGNETI MARELLI

802015

<p>131692 Qty. 5 For rectifier. 200 V. 2.5 Amp.</p>	<p>131693 Qty. 5 For rectifier w/ D+ connection. 200 V. 2.5 Amp.</p>	<p>133401 Qty. 4 O.D. 32 mm, Shaft 17 mm, L. 22.3 mm. W/ 1.8 mm copper.</p>	<p>130703 Qty. 2 Repl. 749 904 31, -51, 749 994 61. Complete w/ brushes. 12 V.</p>	<p>131554 Qty. 1 Repl. 4305661. Complete w/ brushes. 12 V.</p>
<p>JX32 2 Qty. 10 Repl. 4274790. 8 x 5 x 15 / 13.5 mm. 12/24 V.</p>	<p>JX42 2 Qty. 10 Repl. 7970502.1. 7.2 x 4.2 x 17.7 mm. 12 V.</p>	<p>JX30-31 2 Qty. 5 Repl. 4230515. 8 x 5 x 16 / 14.5 mm. 12/24 V.</p>	<p>130704 Qty. 2 Repl. 9935112, 748 766 41. Complete w/ brushes. 12 V.</p>	<p>132323 Qty. 5 Repl. 12058880, Connection.</p>
<p>134727 Qty. 10 5 x 21.5 mm. Rivet.</p>	<p>130813 Qty. 5 Repl. 4474592. 3 x 5 x 13 mm. Key.</p>	<p>130936 Qty. 5 Repl. 10202310. 4 x 5 x 12.65 mm. Key.</p>	<p>133784 Qty. 5 3 x 6.5 x 16 mm. Key.</p>	<p>140116 Qty. 4 Repl. 9923271, 394737A. 12 x 28 x 12 mm.</p>
<p>140265 Qty. 2 Repl. 62202 2RS1. Serv. 633 009 05. 15 x 30 x 14 mm.</p>	<p>132572 Qty. 2 Mounting bushing kit for M12 bolt, L. 29 mm.</p>	<p>134730 Qty. 10 Serv. AA125, 633 022 07, 633 052 06. Insulator B+ terminal.</p>		

Alternator Parts Replacing LUCAS

802016

<p>130910 Qty. 5 Serv. 15, 16, 17, 18 ACR. Rotor shaft nut.</p>	<p>134101 Qty. 2 Serv. A115, A133. Rotor wire separator. Th. 8 mm, 15 mm bore.</p>	<p>134102 Qty. 2 Serv. ACR. Rotor wire separator. Th. 10 mm, 15 mm bore.</p>	<p>134038 Qty. 2 Serv. ACR. Fitting kit. Bearing: Cargo 140084.</p>	<p>134039 Qty. 2 Serv. ACR. Cargo 130857, 130859. Fitting kit. Bearing: Cargo 140091, 6302.</p>	<p>134451 Qty. 5 Wire for rectifier.</p>
<p>131292 Qty. 10 Repl. 83577. 25 Amp. 400 V. Negative.</p>	<p>131293 Qty. 10 Repl. 83576. 25 Amp. 400 V. Positive.</p>	<p>131342 Qty. 2 Repl. 54217372. Serv. ACR. Slotted type w/ clip.</p>	<p>131817 Qty. 2 Repl. UAB101. Serv. A115, A133. O.D. 25 mm, Shaft 9 mm.</p>	<p>132642 Qty. 2 Serv. A127, 24145, 24156, 24157, 24158. O.D. 27 mm, Shaft 17 mm, L. 24 mm.</p>	<p>140161 Qty. 5 Repl. 60600780, ULB105. Serv. A115, A133. 4 x 7 x 20 mm. 12 V.</p>
<p>140444 Qty. 5 Repl. ULB104, -106, -113. Serv. A115, A133. 4 x 7 x 20 mm. 12 V.</p>	<p>140613 Qty. 5 Serv. A127, Cargo 131277, 133788. 4 x 6.9 x 21 mm. 12 V.</p>	<p>LAX31-32 2 Qty. 5 Repl. 54219368, ULB110. Serv. ACR. 4.6 x 4.6 x 12.7 mm. 12 V.</p>	<p>140120 Qty. 4 Serv. A127, 24156. 17.2/23.8 x 17.4 mm.</p>	<p>140240 Qty. 4 Serv. A127 w/ VP. 17.2/23.8 x 17.4 mm. Open.</p>	
<p>130813 Qty. 10 3 x 5 x 13 mm. Key.</p>	<p>132319 Qty. 5 Serv. A127 w/ VP. 17 / 27 x 7 mm. Oil seal S.R.E.</p>	<p>132804 Qty. 2 Repl. 54960402. 3-pin plug w/ terminals.</p>	<p>133802 Qty. 2 Serv. A127, 24217. Terminal insulator.</p>	<p>134345 Qty. 5 Repl. A127, 24188, 24230, 24264. Terminal for Cargo 134811.</p>	

802008 Alternator Parts Replacing MITSUBISHI

<p>132080 Qty. 2 Serv. A529X04971. M17-1.5. Rotor shaft nut set.</p>	<p>133612 Qty. 2 Serv. A529X02171. M17-1.5. Rotor shaft nut set.</p>	<p>134273 Qty. 2 O.D. 21.6 mm, bore 15.5 mm, Th. 5.85 mm. Spacer.</p>	<p>134276 Qty. 2 10.5 x 17/22 x 15 mm. Mtg. bushing, S.R.E.</p>	<p>134277 Qty. 2 10 x 15 x 16.5 mm. Mtg. bushing, S.R.E.</p>	<p>134278 Qty. 2 8.5 x 15.3 x 15.3 mm. Mtg. bushing, S.R.E.</p>	<p>134717 Qty. 2 Serv. I.C. alternators w/ internal fan. Insulator.</p>	<p>134718 Qty. 1 Serv. I.C. alternators w/ internal fan. Cover for Slip ring.</p>
<p>133980 Qty. 10 Paper insulator.</p>	<p>133560 Qty. 2 Terminal O.E. Terminal Kit: Cargo 137842.</p>	<p>133701 Qty. 2 Connector.</p>	<p>133704 Qty. 10 Pos. thin square diode. Low profile block type diode. 30 Amp.</p>	<p>133705 Qty. 10 Neg. thin square diode. Low profile block type diode. 30 Amp.</p>	<p>133409 Qty. 1 Copper rings. O.D. 23 mm, Sh. 12.5 mm, L. 28 mm.</p>	<p>135140 Qty. 1 Slip rings w/ steel rings. O.D. 23 mm, Sh. 12.5 mm, L. 28 mm.</p>	<p>140352 Qty. 5 Repl. A648D01671. 7 x 6 x 18 mm. 12 V.</p>
<p>140354 Qty. 5 Repl. A648D01970. 7 x 6 x 23 mm 12 V.</p>	<p>140437 Qty. 5 Repl. A648D02570. 5 x 8 x 18 mm. 12 V.</p>	<p>133092 Qty. 1 Repl. A450X16371. Serv. A2T13571. M5-0.8. Terminal.</p>	<p>133093 Qty. 1 Repl. A450X17471. Serv. A2T05772. M6-1, L. 52 mm. Term.</p>	<p>133251 Qty. 1 Repl. A450X16271. M6-1, L. 60 mm. Terminal.</p>	<p>134671 Qty. 5 Bore 6 mm, O.D. 21.7 mm. Insulator.</p>	<p>134719 Qty. 1 Repair plug.</p>	<p>133252 Qty. 1 Plug that converts early style alt. into late style w/ oval plug. Coupler</p>
<p>232778 Qty. 2 1P Coupler. W/ lead wire (male).</p>	<p>134996 Qty. 1 3P - 2P Coupler.</p>	<p>134999 Qty. 1 4P - 2 P Coupler.</p>	<p>135000 Qty. 1 4P - 3P Coupler.</p>	<p>135957 Qty. 1 Serv. A2T34598. Terminal.</p>			

802009 Vacuum Pump Parts Replacing MITSUBISHI

<p>133280 Qty. 2 Repl. A990D01101. 4.95 x 12.6 x 27.95 mm. Rotor vane set.</p>	<p>133585 Qty. 2 Repl. A990D01401. 5 x 15.1 x 24 mm. Rotor vane set.</p>	<p>133962 Qty. 2 Repl. A990D01901. 4.9 x 17.6 x 33 mm. Rotor vane set.</p>	<p>134290 Qty. 2 M12-1.5. Screw plug.</p>	<p>132662 Qty. 2 Repl. A351 x 90571. 14.8 x 30 x 5 mm. Oil seal kit.</p>	<p>132663 Qty. 2 Repl. A351X90471. 11.5 x 25.4 x 4.5 mm, 11.5 x 25.4 x 5 mm. Oil seal kit.</p>	
<p>132664 Qty. 2 Repl. A351X90371. 14 x 30.2 x 4.5 mm, 14 x 30.3 x 5 mm. Oil seal kit.</p>	<p>132659 Qty. 5 Repl. S809P56470 61 x 2 mm. O-ring.</p>	<p>132660 Qty. 5 Repl. S809P60270. 25 x 2 mm. O-ring.</p>	<p>133598 Qty. 5 Repl. S809P59201. 72 x 2 mm. O-ring.</p>			
<p>134482 Qty. 5 Repl. S809P58470. 16 x 2.5 mm. O-ring.</p>	<p>135132 Qty. 1 Repl. A584X04371. Serv. A2T07677, -28976, -32277. Valve set.</p>	<p>135133 Qty. 1 Repl. A584X01970. Serv. A2T08799, -41599, -47299. Valve set.</p>	<p>135134 Qty. 1 Repl. A584X02671, MD607753. Serv. A2T01384. Valve set.</p>			
<p>137046 Qty. 1 Repl. A361x05271. M10-1.25/M12-1.50. Vacuum pump connector kit.</p>	<p>080252 Qty. 2 M10-1.0. Hollow screw.</p>	<p>080255 Qty. 2 M14-1.5. Hollow screw.</p>	<p>190806 Qty. 10 I.D. 10 mm. O.D. 16 mm. Th. 1 mm. Copper.</p>	<p>190815 Qty. 10 I.D. 14 mm. O.D. 20 mm. Th. 1.5 mm. Copper.</p>	<p>190820 Qty. 10 I.D. 18 mm. O.D. 24 mm. Th. 1.5 mm. Copper.</p>	<p>191358 Qty. 10 I.D. 12 mm. O.D. 24 mm. Th. 1 mm. Copper.</p>

Alternator Parts Replacing MOTOROLA

802013

<p>132097 Qty. 4 Repl. 1-129. Serv. 9BB..., 9DA..., 9FB....</p>	<p>131218 Qty. 2 Repl. 512-003. O.D. 32 mm, Shaft 19 mm, L. 22.5 mm.</p>	<p>131219 Qty. 2 Repl. 512-055. O.D. 26 mm, Shaft 13.3 mm, L. 25 mm.</p>	<p>131818 Qty. 2 Repl. 512-004. O.D. 32 mm, Shaft 17 mm, L. 22.5 mm.</p>				
	<p>133055 Qty. 2 Serv. 2940304, 2940305, 2940307, 2940309, 2940311, 2940371. O.D. 26.5, Shaft 15 mm, L. 22.6 mm.</p>	<p>MX1 2 Qty. 10 4.5 x 6 x 14.5 mm. 12/24 V.</p>	<p>SVX7 2 Qty. 10 Repl. 300 821. 6.3 x 4.5 x 14 mm. 12 V.</p>				
<p>130933 Qty. 2 Repl. 503-001, -005. Serv. 9AR2561K, -2562K, -2741F, -3868G. Complete w/ brushes.</p>	<p>130976 Qty. 2 Repl. 503-009. Serv. 9AR2610G, -2627G. Complete w/ brushes.</p>	<p>132317 Qty. 2 Repl. 503-008. Serv. 9AL2615, -2618. Complete w/ brushes.</p>	<p>130903 Qty. 2 6200 bearing cap S.R.E. I.D. 30 mm, O.D. 33 mm. L. 13.3 mm.</p>	<p>132237 Qty. 2 Repl. 520-035. Serv. 9AL2507G. Terminal kit.</p>	<p>131605 Qty. 2 Serv. 9AL 2505P. Bracket mtg. bushing kit. Threaded M10.</p>	<p>134781 Qty. 2 Repl. 511-010. Mounting plate.</p>	<p>132324 Qty. 5 Repl. 1900 023 008. 4 x 6.5 x 16 mm. Key.</p>

Alternator Parts Replacing NIPPONDENSO

802004

<p>134273 Qty. 2 O.D. 21.6 mm, Bore 15.5 mm, Th. 5.85 mm. Spacer.</p>	<p>191298 Qty. 5 Repl. 94056-2520. M14-1.5. Rotor shaft nut.</p>	<p>132783 Qty. 2 Repl. 021605-0710. Bore 5 mm. L. 13.5 mm. Insulator for rectifier.</p>	<p>132784 Qty. 2 Repl. 021605-0301. Bore 6 mm. L. 14.7 mm. Insulator for rectifier.</p>	<p>134664 Qty. 2 Repl. 021605-0510. Serv. 100210-.... Insulator.</p>	<p>134668 Qty. 2 Repl. 021605-0280. Bore 5 mm. L. 16.5 mm. Insulator.</p>	<p>134669 Qty. 2 Bore 8.3 mm. O.D. 20.4 mm. Insulator.</p>	<p>134374 Qty. 2 Serv. 121000-0451. Insulator for plug.</p>
<p>134409 Qty. 1 Repl. 021650-0190, 27364-13090. Serv. 021000-9260, 121000-0490. Plug.</p>	<p>133408 Qty. 2 O.D. 33 mm, Shaft 18 mm, L. 25 mm. Stainless steel.</p>	<p>140368 Qty. 5 Repl. 021660-0330. Serv. 100210-.... 5 x 8 x 20.3 mm. 12 V.</p>	<p>140369 Qty. 5 Repl. 021660-0311, -0530. Serv. 100210-.... 5 x 8 x 25.8 mm. 12 V.</p>				
<p>191308 Qty. 20 6 mm. Flange.</p>	<p>133677 Qty. 1 Repl. 021700-2300, 27379-64190. Serv. 100210-3381, -3410. Wire.</p>	<p>134998 Qty. 1 3P - 3P Coupler. Green.</p>	<p>135001 Qty. 1 3P - socket.</p>	<p>132556 Qty. 1 Repl. 021620-1240, -1931, -2250. Serv. 100210-1573, 121000-0820. Complete w/ brushes.</p>	<p>132558 Qty. 1 Repl. 021630-0220, -0530. Serv. 100210-3381, 100213-1011. Complete w/ brushes.</p>		

802003 Alternator Parts, IF Replacing NIPPONDENSO

<p>191298 Qty. 5 Repl. 949056-2520. M14-1.5. Rotor shaft nut.</p>	<p>132862 Qty. 1 Repair plug. 3 prong. Used for repairing broken regulator housings.</p>	<p>132066 Qty. 5 Repl. 021605-1360. Serv. I.C. alt. w/ int. fan. Insulator for stator lead.</p>	<p>133676 Qty. 5 Repl. 021605-1970. Serv. 100210-3381. Insulator for stator lead.</p>	<p>132067 Qty. 2 Repl. 021605-1150. M6 x 25. Insulator for rectifier output terminal.</p>	<p>132785 Qty. 2 Repl. 021605-1850. Insulator for rectifier.</p>	<p>133525 Qty. 2 Repl. 021605-1650. M6 x 28. Insulator for rectifier.</p>	<p>133915 Qty. 2 Repl. 021605-2070. M6/8 x 24. Insulator for rectifier.</p>
<p>134273 Qty. 2 O.D. 21.6 mm, Bore 15.5 mm, Th. 5.85 mm. Spacer.</p>	<p>134720 Qty. 1 Serv. alternators w/ internal fan. 3 pin. Repair plug.</p>	<p>134721 Qty. 1 Serv. alternators w/ internal fan. 4 pin. Repair plug.</p>	<p>132065 Qty. 2 Repl. 021626-0131. Serv. I.C. alternators w/ internal fan. Seal for slip ring and brush box.</p>	<p>133679 Qty. 2 Repl. 021626-0190. Serv. 100210-3380. Seal.</p>	<p>133680 Qty. 2 Repl. 021626-0250. Serv. 100210-3381, 100211-6000. Seal.</p>		
<p>132084 Qty. 2 Repl. 021620-2010, -2180, -2190. Serv. 100211-1000, -1001, -1320, -1321, -2050. Complete w/ brushes.</p>	<p>133673 Qty. 2 Repl. 021620-2530, -2720. Serv. 27040-64030 Toyota Camry Diesel. Complete w/ brushes.</p>		<p>140365 Qty. 5 Repl. 021660-0130. 5 x 8 x 17.6 mm. 12 V.</p>	<p>140370 Qty. 5 Repl. 21660-0370. 5 x 8 x 19.5 mm. 12 V.</p>			
<p>131819 Qty. 5 W/ int. fan. O.D. 14.9 mm. Shaft 9 mm, L 24 mm. Quick rep.: Car. 133610.</p>	<p>134768 Qty. 5 12 x 22 x 2 mm. Fiber washer.</p>	<p>135173 Qty. 2 O.D. 14.9 mm, Shaft 9 mm. L 24 mm. Must be wrenched off. Quick repair: Cargo 133610.</p>	<p>133610 Qty. 2 13.1 / 15.8 x 9.8 mm. Copper ring. Quick repair for slip ring: Cargo 131819, 135173.</p>	<p>133678 Qty. 5 Repl. 021543-0020. Serv. 100210-3070. M5 x 21. Stud.</p>	<p>191308 Qty. 20 M6. Hex nut.</p>		

802005 Vacuum Pump Parts Replacing NIPPONDENSO

<p>134395 Qty. 1 Repl. 081200-0170. Serv. 081000-1321, -1480, -1611. L. 23 mm, O.D. 44.2 mm, 16 splines. Rotor V.P.</p>	<p>134396 Qty. 1 Repl. 081200-0130. Serv. 081000-1491. L. 23 mm, O.D. 50.3 mm, 18 splines. Rotor V.P.</p>	<p>133281 Qty. 2 Repl. 081204-0070. 7.05 x 17.6 x 62 mm. Rotor vane set.</p>	<p>133282 Qty. 2 Repl. 081204-0110. 6.1 x 14.8 x 23.1 mm. Rotor vane set.</p>	<p>133283 Qty. 2 Repl. 081204-0240. 4.1 x 12.7 x 23 mm. Rotor vane set.</p>			
<p>133813 Qty. 1 Repl. 081204-0080. 7.1 x 13.5 x 35.2 mm. Rotor vane set.</p>	<p>132549 Qty. 2 Repl. 949150-0921. 15.5 x 30.1 x 7 mm. Oil seal.</p>	<p>133513 Qty. 2 14 x 30 x 7 mm. Oil seal.</p>	<p>133523 Qty. 2 Repl. 081103-0060. 19 x 32 x 6 mm. Oil seal.</p>	<p>133524 Qty. 2 Repl. 081103-0080. 17 x 30/37 x 8 mm. Oil seal.</p>	<p>133040 Qty. 5 Repl. 949140-3540. 56 x 2 mm, S.R.E. O-ring.</p>	<p>133597 Qty. 5 64 x 2.5 mm. O-ring.</p>	
<p>134293 Qty. 1 Repl. 081221-0070. M14-1.5. L 42.2 mm. Spanner size 27 mm.</p>	<p>134294 Qty. 1 Repl. 081221-0110. M14-1.5. L 42.2 mm. Spannersize 19 mm.</p>	<p>135135 Qty. 1 Repl. 081220-0210. M18-1.5. L. 41.7 mm. Spanner size 24 mm.</p>	<p>135136 Qty. 1 Repl. 081220-0060. M14-1.5. L. 52.7 mm. Spanner size 19 mm.</p>	<p>080001 Qty. 2 M10-1.25. Hollow screw.</p>	<p>080255 Qty. 2 M14-1.5. Bore 8 mm. Hollow screw.</p>	<p>080009 Qty. 10 I.D.: 10 mm. O.D.: 14 mm. Th.: 1 mm. Copper.</p>	<p>190815 Qty. 10 I.D.: 14 mm. O.D.: 20 mm. Th.: 1.5 mm. Copper.</p>
<p>190819 Qty. 10 I.D.: 18 mm. O.D.: 22 mm. Th.: 1.5 mm. Copper.</p>	<p>190820 Qty. 10 I.D.: 18 mm. O.D.: 24 mm. Th.: 1.5 mm. Copper.</p>	<p>133514 Qty. 2 27 x 40 x 2 mm. Felt.</p>	<p>133527 Qty. 2 15 x 36 x 2 mm. Felt.</p>	<p>134760 Qty. 2 35 x 50 x 5 mm. Felt.</p>	<p>134767 Qty. 2 15 x 45 x 5 mm. Felt.</p>	<p>134766 Qty. 2 15 x 41 x 1 mm. Rubber gasket.</p>	

Alternator Parts Replacing PARIS RHONE / VALEO 802014

<p>134144 Qty. 5 For regulator - Cargo 131120. Connection.</p>	<p>130842 Qty. 2 Repl. 49100327. O.D. 30 mm. Sh. 15 mm, L 21.4 mm.</p>	<p>131814 Qty. 1 Serv. A13N ..., A14N ... O.D. 30 mm, Shaft 17 mm, L. 28 mm.</p>	<p>131815 Qty. 1 Serv. A13N ..., A14 ... O.D. 30 mm, Shaft 15 mm, L. 27 mm.</p>	<p>132295 Qty. 2 Serv. A13N ..., A14N ... O.D. 30 mm, Shaft 17 mm, L. 28 mm.</p>		
<p>133351 Qty. 1 O.D. 34 mm, Shaft 17 mm. L. 23 mm. 6 Splines.</p>	<p>132848 Qty. 5 Serv. Cargo 131814, 131815, 132295. Insulator for slip ring.</p>	<p>133365 Qty. 2 27 x 30 x 8.4 mm. Quick rep. for slip ring: Cargo 131814, 131815.</p>	<p>133366 Qty. 2 27 x 30 x 10 mm. Quick rep. for slip ring: Cargo 131814, 131815.</p>	<p>PX52-54 2 Qty. 5 Repl. 75411H. 7 x 5 x 19 mm. 12 V.</p>		
<p>PX58 2 Qty. 5 Repl. 300665. Serv. A14R33, -39T. 10 x 5 x 17 mm. 12/24 V.</p>	<p>PX60 2 Qty. 5 Repl. 92950. 6.35 x 4.6 x 15.4 mm. 12 V.</p>	<p>135169 Qty. 5 Serv. A11VI..., A13VI. Terminal Cap. Alternators w/ internal fan.</p>	<p>131055 Qty. 5 Repl. 72534. Serv. A12M5, -8. Fuse 35 Amp.</p>	<p>131583 Qty. 5 Repl. 98882. Serv. A12M9, -11, -15. Fuse 30 Amp.</p>	<p>130903 Qty. 2 Repl. 79058. I.D. 30, O.D. 33 mm. L. 13.25 mm.</p>	<p>131826 Qty. 2 Repl. 105299. I.D. 32, O.D. 34 mm. L. 14 mm.</p>
<p>131827 Qty. 2 Repl. 104809. I.D. 30, O.D. 31.7 mm. L. 13.4 mm.</p>	<p>131828 Qty. 2 Repl. 77973. I.D. 32, O.D. 35 mm. L. 15 mm.</p>	<p>133648 Qty. 2 Serv. 294 ... I.D. 30, O.D. 32.5 mm. L. 11.5 mm.</p>	<p>133739 Qty. 5 Serv. A13N ... M5 x 50. B+ terminal.</p>	<p>133740 Qty. 5 Serv. A13N ... M6 x 60. B+ terminal.</p>	<p>131606 Qty. 2 Serv. A14R3, -17, -27. Mounting bushing kit. Threaded M10.</p>	

Alternator Parts Replacing SEV

802022

<p>131822 Qty. 5 Rotor shaft nut, fine threaded.</p>	<p>132080 Qty. 2 M17-1.5. Rotor shaft nut set.</p>	<p>130682 Qty. 2 Repl. 712 09803, -13003. Serv. 712 10002, -10302, -10402. Diode trio.</p>	<p>130961 Qty. 2 Repl. 712 14003, -14103. Serv. 712 12302, -12402, -12602. Diode trio.</p>	<p>130718 Qty. 2 Repl. 719 51903. O.D. 39 mm, Shaft 19.5 mm, L. 24.6 mm.</p>
<p>131037 Qty. 2 Repl. 719 51703. O.D. 39 mm, Shaft 17 mm, L. 24 mm.</p>	<p>133351 Qty. 2 Serv. Rotor 711 53403, 131645. O.D. 34 mm, Shaft 17 mm, L. 23 mm. 6 splines</p>	<p>130713 Qty. 1 Repl. 719 31093. Serv. 712 10302, -10402, -10602, -10702. Complete w/ brushes.</p>	<p>130714 Qty. 1 Repl. 719 31403. Serv. 712 12302, -12402, -12602, 713 12002. Complete w/ brushes.</p>	
<p>131704 Qty. 1 Repl. 719 31003. Serv. 712 00002, -00102. Complete w/ brushes.</p>	<p>SVX5 2 Qty. 5 4.5 x 6.3 x 13.5 mm. 12 V.</p>	<p>SVX7 2 Qty. 5 Repl. 300 821. 4.5 x 6.3 x 14 mm. 12 V.</p>	<p>SVX9 2 Qty. 5 4.6 x 6.4 x 15 mm. 12 V.</p>	
<p>131608 Qty. 5 Serv. 702 20002. Bracket mounting bushing kit.</p>	<p>131827 Qty. 2 Repl. 719 97103. 6200 bearing cap S.R.E. I.D. 30 mm, O.D. 31.7 mm, L 13.4 mm.</p>	<p>132320 Qty. 2 Repl. 717 81003. Serv. 712 30302. Terminal cover.</p>	<p>133199 Qty. 2 Repl. 1234926-2. Serv. Volvo. 3-pin terminal.</p>	<p>133650 Qty. 10 Wire clip.</p>

802024 VARIOUS - IC Regulator for Hi / Mi / ND

 130834 Qty. 1 Repl. TR1Z-48. 12 V. Repair circuit w/ terminals E-F-L-S-B.	 131287 Qty. 1 Repl. TR1Z-64. 12 V. Repair circuit w/ terminals E-F-L-R-S-B.	 131528 Qty. 1 Repl. TR1Z-46. 12 V. Repair circuit w/ terminals E-F-B-S-R.	 132292 Qty. 1 Repl. TR 2Z-37. 24 V. Repair circuit w/ terminals E-F-L-R-S-B.	 132434 Qty. 1 Repl. TR 1Z-34. 12 V. Repair circuit w/ terminals R-R-L-F-E.	 136284 Qty. 1 12 V. Repair circuit w/ terminals B-S-R-L-F-E. <i>Same as Cargo 131287, but New Era type.</i>	 133235 Qty. 1 Serv. 126000-0340. 12 V. Repair circuit w/ terminals S-IG-L.	
 133236 Qty. 1 Serv. 126000-0440, Cargo 132856. 12 V. Repair circuit w/ terminals C-IG-L.	 133238 Qty. 1 Serv. 126000-0570, Cargo 132831. 12 V. Repair circuit w/ terminals D-FR-IG-L.	 133239 Qty. 1 Serv. 126000-0540, -1060, Cargo 132645. 12 V. Repair circuit w/ terminals S-FR-IG-L.	 133240 Qty. 1 Serv. 126000-0550, -0900, Cargo 132855. 12 V. Repair circuit w/ terminals S-IG-L.				
 133241 Qty. 1 Serv. 126000-0410. 12 V. Repair circuit w/ terminals D-IG-L.	 133242 Qty. 1 Serv. 126000-0170. 12 V. Repair circuit w/ terminals S-IG-L.	 133243 Qty. 1 Serv. A866X04870. 12 V. 4-pin repair circuit w/ terminals R-L.	 133244 Qty. 1 Serv. A866X05272. 12 V. 4-pin repair circuit w/ terminals S-L.	 133245 Qty. 1 12 V. 5-pin repair circuit w/ terminals S-L and right hand plug.	 133246 Qty. 1 12 V. 5-pin repair circuit w/ terminals S-L and left hand plug.	 133247 Qty. 1 Serv. Cargo 132992. 12 V. Repair circuit w/ terminals B-S-L-F-E.	 133248 Qty. 1 12 V. Repair circuit w/ terminals B-S-L-F-E. O.E. style only.
 133249 Qty. 1 12 V. Repair circuit w/ terminals E-F-T-L-S. O.E. style only.	 133250 Qty. 1 Serv. Cargo 132991. 12 V. Repair circuit w/ terminals L-S-T-F-E.	 133258 Qty. 1 Serv. 126000-0720. 12 V. Repair circuit w/ terminals D-IG-L.	 133259 Qty. 1 Serv. 126000-0600. 12 V. Repair circuit w/ terminals S-IG-L.	 135023 Qty. 1 Serv. 126000-0410. 12 V. Repair circuit w/ terminals D-IG-L.	 135025 Qty. 1 Serv. L170-23152. 12 V. Repair circuit w/ terminals S-IG-L.	 135026 Qty. 1 Repl. TR2Z-47. 24 V. Repair circuit w/ terminals R-R-L-F-E.	











802011 VARIOUS - Diodes - Alternators

 130669 Qty. 6 25 Amp. 100 V. 1/2" (12.7 mm) press fit. 27 mm lead. Pos.	 130670 Qty. 6 25 Amp. 100 V. 1/2" (12.7 mm) press fit. 27 mm lead. Neg.	 130671 Qty. 6 35 Amp. 100 V. 1/2" (12.7 mm) press fit. 55 mm flex. lead. Neg.	 130672 Qty. 6 25 Amp. 100 V. 1/2" (12.7 mm) press fit. 25 mm flex. lead. Pos. <i>W/ 4 mm. terminal</i>	 130911 Qty. 6 35 Amp. 200 V. 1/2" (12.7 mm) press fit. 20 mm lead. Neg.	 130912 Qty. 6 35 Amp. 200 V. 1/2" (12.7 mm) press fit. 20 mm lead. Pos.	 131292 Qty. 6 25 Amp. 400 V. 10 mm press fit. 20 mm. lead. Neg.	 131293 Qty. 6 25 Amp. 400 V. 10 mm press fit. 20 mm. lead. Pos.
 131506 Qty. 6 25 Amp. 100 V. 0.34" (8.7 mm) press fit. 18 mm lead. Neg.	 131507 Qty. 6 25 Amp. 100 V. 0.34" (8.7 mm) press fit. 18 mm lead. Pos.	 131508 Qty. 6 20 Amp. 300 V. 0.33" (8.4 mm). 18 mm lead. Neg.	 131509 Qty. 6 20 Amp. 300 V. 0.33" (8.4 mm). 18 mm lead. Pos.	 131510 Qty. 6 30 Amp. 300 V. 0.38" (9.7 mm). 18 mm lead. Neg.	 131511 Qty. 6 30 Amp. 300 V. 0.38" (9.7 mm). 18 mm lead. Pos.	 131512 Qty. 6 35 Amp. 200 V. 0.4" (10 mm). Pos. or Neg. Cathode = white ring.	 131513 Qty. 6 25 Amp. 100 V. 0.4" (10 mm). 24 mm lead. Neg.
 131514 Qty. 6 25 Amp. 100 V. 0.4" (10 mm). 24 mm lead. Pos.	 133193 Qty. 6 35 Amp. 100 V. 1/2" (12.7 mm) press fit. Flexible lead. Pos.	 133194 Qty. 6 35 Amp. 100 V. 1/2" (12.7 mm) press fit. Flexible lead. Neg. <i>W/ 4 mm. terminal</i>	 133495 Qty. 3 70 Amp. 1 milliamp. 400 V. 1/4 - 28 stud. Pos.	 133496 Qty. 3 70 Amp. 1 milliamp. 400 V. 1/4 - 28 stud. Neg.	 133704 Qty. 6 Pos. thin square diode. Low profile block type diode. 30 Amp.	 133705 Qty. 6 Neg. thin square diode. Low profile block type diode. 30 Amp.	 135152 Qty. 6 Tin can 5/16" 35 Amp. 400 V. Negative.
 135153 Qty. 6 Tin can 5/16" 35 Amp. 400 V. Negative.	 130937 Qty. 6 Repl. 0270 000 009, Si Diode. Serv. 1121 099 007, Cargo 131095. 1 Amp. 1000 V.	 131294 Qty. 6 3 Amp. 1000 V.	 134519 Qty. 6 6 Amp. 400 V.	 135213 Qty. 6 Serv. Hitachi, Lucas, Mitsubishi, Motorola. 2 Amp. 200 V.			

O.E.M. names and numbers are used for reference purposes only.

VARIOUS - Slip Rings

802032

















 <p>133401 Qty. 2 Repl. 1124 304 007. O.D. 32 mm. Sh. 17 mm. L. 22.3 mm. Copper Th. 1.8 mm.</p>	 <p>133402 Qty. 2 Repl. 1124 303 001. O.D. 28 mm. Sh. 17 mm. L. 22.1 mm. Copper Th. 1.8 mm.</p>	 <p>133924 Qty. 2 Serv. CS 121, 130. O.D. 26.1/26.4 mm. Sh. 13.2 mm. L. 23.8 MM.</p>	 <p>131817 Qty. 2 Repl. UAB101. Serv. A115, A133. O.D. 25 mm. Sh. 9 mm.</p>	
 <p>132642 Qty. 2 Serv. A127, 24145, 24156, 24157. O.D. 27 mm. Sh. 17 mm. L. 24 MM.</p>	 <p>131342 Qty. 2 Repl. 54217372, UAB104. Serv. ACR. Slotted type, w/ clip..</p>	 <p>131814 Qty. 2 Serv. A13N..., A14N.. O.D. 30 mm. Sh. 17 mm. L. 28 MM.</p>	 <p>131816 Qty. 2 Serv. I.C. Alternators. O.D. 30 mm. Sh. 17 mm. L. 27.4 MM.</p>	
 <p>135173 Qty. 2 Serv. A11VI..., A13VI.. O.D. 14.85 mm. Sh. 7.9/8.75 mm. L. 28 MM. Quick repair: Cargo 133610</p>	 <p>133351 Qty. 2 O.D. 34 mm. Sh. 17 mm. L. 23 mm. 6 splines.</p>	 <p>135054 Qty. 2 Serv. LR170-715B, 716B, 717. O.D. 27.5 mm. Sh. 14 mm. L. 29.5 mm.</p>	 <p>133410 Qty. 2 O.D. 35 mm. Sh. 17 mm. L. 31.1 mm.</p>	
 <p>133409 Qty. 2 Copper rings. O.D. 23 mm. Sh. 12.5 mm. L. 28 mm.</p>	 <p>135140 Qty. 2 Same as 133409, but w/ steel rings. O.D. 23 mm. Sh. 12.5 mm. L. 28 mm.</p>	 <p>138441 Qty. 1 Serv. A115i, A127i. O.D. 16 mm. Sh. 6.8 mm. L. 46.5 MM.</p>	 <p>135315 Qty. 2 O.D. 33 mm. Sh. 17.5 mm. L. 31.1 mm. Steel.</p>	

VARIOUS - Brushes

802031

 <p>BX182 2 Qty. 2 Repl. BOSCH 1127 014 009. 5 x 10 x 17 mm. 12 V.</p>	 <p>BX185 2 Qty. 2 Repl. BOSCH 1127 014 011. 5 x 8 x 15 mm. 12 V.</p>	 <p>RX103F 2 Qty. 2 Repl. DELCO DR702. Serv. Opel, Vauxhall. 4.6 x 4.6 x 13.2 mm. 12 V.</p>	 <p>140342 Qty. 2 Repl. HITACHI L150-13251, 23135-01B00. 5 x 7 x 17 mm. 12 V.</p>
 <p>140380 Qty. 2 Repl. HITACHI L150-23251, 23124-Z9000. 5 x 7 x 21 mm. 12 V.</p>	 <p>140343 Qty. 2 Repl. HITACHI L150M-13251, 23134-61S01. 5 x 7 x 21 mm. 12 V.</p>	 <p>LAX31-32 2 Qty. 2 Repl. LUCAS 54219368, ULB110. Serv. ACR. 4.6 x 4.6 x 12.7 mm. 12 V.</p>	 <p>140353 Qty. 2 Repl. MITSUBISHI A648D02070. 7 x 6 x 18 mm. 12 V.</p>
 <p>140351 Qty. 2 Repl. MITSUBISHI A648C01570. 7 x 6 x 17 mm. 12 V.</p>	 <p>140437 Qty. 2 Repl. MITSUBISHI A648D02570. 5 x 8 x 18 mm. 12 V.</p>	 <p>MX1 2 Qty. 2 Repl. MOTOROLA 1-4155A01. 4.5 x 6 x 14.5 mm. 12/24 V.</p>	 <p>140365 Qty. 2 Repl. NIPPONDENSO 021660-0130. 4.5 x 6.3 x 14 mm. 12 V.</p>
 <p>140369 Qty. 2 Repl. NIPPONDENSO 021660-0311. 5 x 8 x 25.8 mm. 12 V.</p>	 <p>140367 Qty. 2 Repl. NIPPONDENSO 021660-0320. 4 x 5 x 17 mm. 12 V.</p>	 <p>PX52-54 2 Qty. 2 Repl. PARIS RHONE 75411H. 5 x 7 x 19 mm. 12 V.</p>	 <p>SVX7 2 Qty. 2 Repl. SEV 300 821. 4.5 x 6.3 x 14 mm. 12 V.</p>

802027 VARIOUS - Brushes - Japanese Alternators

 140342 Qty. 2 Repl. Hitachi L150-13251. 5 x 7 x 17 mm. 12 V.	 140343 Qty. 2 Repl. Hitachi L150M-13251. 5 x 7 x 21 mm. 12 V.	 140380 Qty. 2 Repl. Hitachi L150-23251. 5 x 7 x 21 mm. 12 V.	 140351 Qty. 2 Repl. Mitsubishi A648C01570. 7 x 6 x 17 mm. 12 V.
 140352 Qty. 2 Repl. Mitsubishi A648D01671. 7 x 6 x 18 mm. 12 V.	 140353 Qty. 2 Repl. Mitsubishi A648D02070. 7 x 6 x 18 mm. 12 V.	 140354 Qty. 2 Repl. Mitsubishi A648D01970. 7 x 6 x 23 mm. 12 V.	 140437 Qty. 2 Repl. Mitsubishi A648D02570. 5 x 8 x 18 mm. 12 V.
 140576 Qty. 2 Repl. Mitsubishi A648D03070. 5 x 8 x 23 mm. 12 V.	 140577 Qty. 2 Repl. Mitsubishi 648C02970. 5 x 8 x 18 mm. 12 V.	 140365 Qty. 2 Repl. Nippondenso 021660-0130. 5 x 8 x 17.6 mm. 12 V.	 140367 Qty. 2 Repl. Nippondenso 021660-0320. 4 x 5 x 17 mm. 12 V.
 140368 Qty. 2 Repl. Nippondenso 021660-0330. 5 x 8 x 20.3 mm. 12 V.	 140369 Qty. 2 Repl. Nippondenso 021660-0311. 5 x 8 x 25.8 mm. 12 V.	 140370 Qty. 2 Repl. Nippondenso 021660-0370. 5 x 8 x 19.5 mm. 12 V.	 140371 Qty. 2 Repl. Nippondenso 021660-0390. 5 x 7 x 14.3 mm. 12 V.

802002 VARIOUS - Special Bearings - Jap. Alternators

 140231 Qty. 1 Repl. S930P17170. 8 / 22 x 11 mm. W/ snap ring.	 140232 Qty. 1 Repl. S930P17970. 8 / 23 x 11 mm. W/ snap ring.	 140233 Qty. 1 Repl. 6900 BPL. 10 / 23 x 11 mm. W/ snap ring.	 140234 Qty. 1 Repl. S930P18570. 8 / 23 x 14 mm. W/ snap ring.	 140235 Qty. 1 Repl. B10-50D. 10 / 27 x 11 mm. W/ snap ring. S.R.E.	 140236 Qty. 1 Repl. 949100-2140. 12 / 35 x 18 mm. S.R.E.
 140237 Qty. 1 Repl. 949100-2790. 15 / 35 x 13 mm. S.R.E.	 140239 Qty. 1 Repl. 949100-3360. 15 / 46 x 14 mm. D.E.	 140417 Qty. 1 Repl. S930P61201, S210-24-523. 12 / 32 x 10 mm. W/ snap ring.	 140419 Qty. 1 Repl. S930P63670, N33618W36, SL8AD5LHI. 8 / 23 x 14 mm.		
 140420 Qty. 1 Repl. S930P63070. B15-86D. 15 / 47 x 14 mm.	 140432 Qty. 1 Repl. 23129-16A00. 15 / 35 x 11 mm. W/ snap ring.	 140434 Qty. 1 Repl. 6202NCD. 15 / 35 x 13 mm. W/ snap ring.	 140441 Qty. 1 Repl. 949100-3170. 15 / 32 x 11 mm.	 140443 Qty. 1 Repl. 949100-3190, 90099-10152. 15 / 43 x 13 mm.	 140460 Qty. 1 Repl. 949100-3330, -4370. 17 / 52 x 16 mm.
 140461 Qty. 1 Repl. 949100-3480. 15 / 38 x 19 mm.	 140462 Qty. 1 Repl. 949100-3820. 15 / 52 x 16 mm.	 140588 Qty. 1 Repl. SC0081LHIA. 10 / 27 x 14 mm. W/ 2 teflon tolerance rings.	 140589 Qty. 1 Repl. B17-107D. 17 / 47 x 18 mm.		

VARIOUS - Special Bearings - Eur. Alternators

802025

 140105 Qty. 1 Repl. 1900 905 282. Serv. 0120 489 643. 12/32 x 14 mm.	 140116 Qty. 1 Repl. 394737A. 12/28 x 12 mm.	 140176 Qty. 1 Repl. 1120 900 008, 1120 900 010, 365740BB1B. 17/62 x 17.5 mm.		 140263 Qty. 1 Repl. 1120 905 012, 363226C. 17/52 x 17 mm.	 140442 Qty. 1 Repl. 62304-2RS. 20/52 x 21 mm.
 140516 Qty. 1 Repl. 1900 910 032. Serv. 0120 600... 25 x 52 x 15 mm.		 140265 Qty. 1 Repl. 62202 2RS. Serv. 633 009 05. 15/30 x 14 mm.	 140120 Qty. 1 Repl. 9436831. Serv. 10 Sl, 12 Sl. 17/23.8 x 17.4 mm.	 140569 Qty. 1 Repl. 1120 905 005. 17/52 x 21 mm.	 140401 Qty. 1 Repl. 102130. 17/62 x 17 mm.
 140515 Qty. 1 Repl. 1900 910 024. Serv. 0120 689... 15/35 x 11 mm.	 140266 Qty. 1 Repl. 24940240. 17/47 x 19 mm.	 140240 Qty. 1 17/23.8 x 17.4 mm. Open.	 140106 Qty. 1 Repl. SE 5 KDD. Serv. C40T. ½"/1 1/8" x 5/16".	 140115 Qty. 1 Repl. 3472455. Serv. Opel, Vauxhall. 11.5/17.5 16.5 mm.	

VARIOUS - Small Bearings - Alternators

802026

 140296 Qty. 5 Repl. 607 2Z/C3. 7/19 x 6 mm.	 140222 Qty. 5 Repl. 608 2RS1/C3. 8/22 x 7 mm.	 140459 Qty. 5 Repl. 625 2RS1/C3. 5/16 x 5 mm.	 140523 Qty. 5 Repl. 626 2RS1/C3. 6/19 x 6 mm.	 140300 Qty. 5 Repl. 627 2Z/C3. 7/22 x 7 mm.	 140301 Qty. 5 Repl. 629 2Z/C3. 9/26 x 8 mm.	 B140271P Qty. 5 Repl. 6000 2RS1/C3. 10/26 x 8 mm.	 B140077P Qty. 5 Repl. 6001 2RS1/C3. 12/28 x 8 mm.
 B140272P Qty. 5 Repl. 6002 2RS1/C3. 15/32 x 9 mm.	 B140273P Qty. 5 Repl. 6003 2RS1/C3. 17/35 x 10 mm.	 B140223P Qty. 2 Repl. 6004 2RS1/C3. 20/42 x 12 mm.	 B140274P Qty. 2 Repl. 6005 2RS1/C3. 25/47 x 12 mm.		 B140079P Qty. 5 Repl. 6200 2RS1/C3. 10/30 x 9 mm.	 B140081P Qty. 5 Repl. 6201 2RS1/C3. 12/32 x 10 mm.	 B140084P Qty. 2 Repl. 6202 2RS1/C3. 15/35 x 11 mm.
 B140087P Qty. 2 Repl. 6203 2RS1/C3. 17/40 x 12 mm.	 B140218P Qty. 2 Repl. 6204 2RS1/C3. 20/47 x 14 mm.		 B140219P Qty. 2 Repl. 6205 2RS1/C3. 25/52 x 15 mm.		 140635 Qty. 2 Repl. 6300-2RS1/C3. 10/35 x 11 mm.	 B140220P Qty. 2 Repl. 6306 2RS1/C3. 30/62 x 16 mm.	
 B140277P Qty. 2 Repl. 6301 2RS1/C3. 12/37 x 12 mm.	 B140091P Qty. 2 Repl. 6302 2RS1/C3. 15/42 x 13 mm.	 B140093P Qty. 2 Repl. 6303 2RS1/C3. 17/47 x 14 mm.		 B140278P Qty. 2 Repl. 6304 2RS1/C3. 20/52 x 15 mm.			

802035 VARIOUS - Needle Bearings

 141168 Qty. 2 HK 0408. 4/8 x 7.9 mm.	 140752 Qty. 2 Serv. PG 200. -250. 9.5/14.3 x 7.9 mm. Drive shaft.	 140620 Qty. 5 HK 0608. 6/10 x 8 mm.	 140751 Qty. 5 HK 0808. 8/12 x 8 mm.	 140617 Qty. 5 HK 0509. 5/9 x 9 mm.	 140619 Qty. 5 HK 0609. 6/10 x 9 mm.	 140468 Qty. 2 Serv. PMGR series. HK 0810. 8/10 x 10 mm. Gear shaft	 140935 Qty. 2 HK 0910. 4/13 x 10 mm.
 140482 Qty. 5 Repl. HK 1010. Serv. E95R. Gear reduction starters. 10/14 x 10 mm.	 140242 Qty. 5 Repl. 9001 140 384. Serv. Gear reduction starter. 12/16 x 10 mm.	 141001 Qty. 2 Serv. D7R... 10/14 x 12 mm.	 140903 Qty. 1 NK 1012. 10/17 x 12 mm.	 140514 Qty. 2 Repl. S933P65270. Serv. Mitsubishi. 12/17 x 12 mm.	 140494 Qty. 10 FAG. HK 1212. 12 x 18 x 12 mm.	 140876 Qty. 1 Repl. TLA141912ZE01. Serv. M2T56471. 14/18.73 x 12 mm. I.M. Bracket.	 140503 Qty. 2 HK 1412. 14/20 x 12 mm.
 140495 Qty. 2 HK 1512. 15/21 x 12 mm.	 140375 Qty. 2 Serv. D9R... 18/24 x 12 mm.	 141209 Qty. 2 Repl. SCE98. Serv. 1S7U-11000-BA. 14.14/19.05 x 12.65 mm.	 140552 Qty. 1 Repl. E4FZ-11052A. Serv. C.E. and gear housing. 15.9/20.65 x 12.7 mm.	 140807 Qty. 3 Repl. 1000 917 004. 10/14 x 14 mm.	 140919 Qty. 2 Repl. 186448. 10/14 x 14 mm.	 141054 Qty. 2 Repl. 1000 917 000. 12 x 16 x 14 mm.	 140483 Qty. 2 Repl. HK 1214RS. Serv. E95R. 12/18 x 14 mm.
 141039 Qty. 2 HK 1514RS. 15/21 x 14 mm.	 141219 Qty. 2 Repl. UMB110 Harley Davidson. 12.7/17.5 x 14.2 mm. Closed end.	 140767 Qty. 1 Repl. KOYO 11MFNM 1515 NM. Serv. 128000-28000. 11/15.5 x 14.3 mm.	 140738 Qty. 1 Repl. S933P70605. Serv. M1T76381. 10/15 x 15 mm.	 141090 Qty. 2 Repl. D501005C. 10 x 15/12.5 x 15.4 mm.	 140904 Qty. 2 Repl. 9003 330 903. 12/18 x 16 mm.	 140768 Qty. 1 Repl. KOYO 13MFNM 1717TCU. Serv. 128000-1683. 12.5/17 x 17 mm.	 140421 Qty. 2 Repl. 1975322. 17/23.8 x 20.6 mm.

802029 VARIOUS - Oil Seals for Alternators

 132297 Qty. 5 Repl. L150M-19221, 14658-36W00. Serv. LR225-65. Alternators w/ VP. 15 x 32 x 7 mm. Single oil seal S.R.E.	 132319 Qty. 5 Serv. A 127 w/ VP. 17 x 27 x 7 mm. Oil seal S.R.E.	 132549 Qty. 3 Repl. 949150-0921. Serv. Toyota. 15.5 x 30.1 x 7 mm. Oil seal.	 132661 Qty. 5 Repl. L150-1922, 14658-44G00. Serv. LR235-402. Alternators w/ VP. 15 x 32 x 7.5 mm. Twin oil seal S.R.E.	
 132662 Qty. 1 Repl. A351X90571. Serv. A2T01384, -01077, Mazda. 14.8 x 30 x 5 mm. Oil seal kit.	 132663 Qty. 1 Repl. A351X90471. Serv. A2T41599, Mitsubishi. 11.5 x 25.4 x 4.5 mm, 11.5 x 25.4 x 5 mm. O/s kit.	 132664 Qty. 1 Repl. A351X90371, 0636-24-414. Serv. A2T11173, AP2030F, Mitsubishi. 14 x 30.2 x 4.5 mm, 14 x 30.3 x 5 mm. Oil seal kit.	 132734 Qty. 5 Repl. 9491 140 202, -204. Serv. 0120 488 000, -001, -002, -003. 12 x 24 x 6 mm. Oil seal S.R.E.	
 133065 Qty. 3 Repl. 111-46, -54, -76. Serv. 8LHC 2004Z. O.D. 1.852".	 133513 Qty. 5 14 x 30 x 7 mm. Oil seal.	 133523 Qty. 5 Repl. 081103-0060. 19 x 32 x 6 mm. Oil seal.	 133524 Qty. 5 Repl. 081103-0080. 17 x 30/37 x 8 mm. Oil seal.	 136014 Qty. 3 Repl. 1120 283 000. Serv. 0120 689 502. 20 x 35 x 7 mm. Oil seal.
 138369 Qty. 5 Repl. L150-2922. Serv. LR155-502B. 11 x 28 x 7.5 mm. Oil seal.	 136016 Qty. 1 Repl. 2120 283 000. Serv. 0120 600.... 38 x 52 x 7 mm. Oil seal D.E.	 137803 Qty. 1 Repl. 081099-0090. Serv. 100210-2211, -2231, -2290. Oil seal kit.	 138130 Qty. 1 Repl. 1958509. Serv. 25 SI, 26 SI. 35 x 51 x 8 mm. Oil seal.	

O.E.M. names and numbers are used for reference purposes only.

VARIOUS - Bearing Tolerance Rings - Alternators

802010

 140243 Qty. 5 32 x 10 mm. Recomd. housing bore: 33.88 - 33.97 mm.	 140244 Qty. 5 35 x 10 mm. Recomd. housing bore: 36.88 - 36.97 mm.	 140245 Qty. 5 40 x 12 mm. Recomd. housing bore: 41.88 - 41.97 mm.	 140246 Qty. 3 47 x 14 mm. Recomd. housing bore: 48.88 - 48.97 mm.	 140247 Qty. 2 52 x 15 mm. Recomd. housing bore: 54.34 - 54.46 mm.	 140616 Qty. 5 26 x 8 mm. Recomd. housing bore: 27.88 - 27.97 mm.		
 140718 Qty. 5 28 x 10 mm. Recomd. housing bore: 29.75 - 29.98 mm.	 140719 Qty. 5 28 x 12 mm. Recomd. housing bore: 29.75 - 29.98 mm.	 140720 Qty. 5 32 x 14 mm. Recomd. housing bore: 33.67 - 33.89 mm.	 140721 Qty. 5 35 x 14 mm. Recomd. housing bore: 36.75 - 36.98 mm.	 140131 Qty. 3 28/30 x 10 mm. Recomd. housing bore: 30 mm.	 140132 Qty. 2 32/35 x 11.5 mm. Recomd. housing bore: 35 mm.	 140133 Qty. 2 32/36 x 13 mm. Recomd. housing bore: 36 mm.	 140504 Qty. 2 32/36 x 16 mm. Recomd. housing bore: 36 mm.
 140608 Qty. 3 23/25 x 11 mm. Recomd. housing bore: 25 mm.	 140609 Qty. 3 27/29 x 11 mm. Recomd. housing bore: 29 mm.	 140610 Qty. 2 47/50 x 18 mm. Recomd. housing bore: 50 mm.	 140611 Qty. 2 46/49 x 13.2 mm. Recomd. housing bore: 49 mm.	 140612 Qty. 2 43/46 x 13.2 mm. Recomd. housing bore: 46 mm.	 140651 Qty. 2 32/37 x 12.5 mm. Recomd. housing bore: 37 mm.		
 140699 Qty. 3 35/38 x 15.5 mm. Recomd. housing bore: 38 mm.	 140700 Qty. 3 30/34 x 15 mm. Recomd. housing bore: 34 mm.	 140701 Qty. 3 30/34 x 12 mm. Recomd. housing bore: 34 mm.	 140702 Qty. 3 32/35 x 15.5 mm. Recomd. housing bore: 35 mm.	 140703 Qty. 3 28/30 x 14.8 mm. Recomd. housing bore: 30 mm.	 140739 Qty. 5 26/28 x 8 mm. Recomd. housing bore: 28 mm.	 140722 Qty. 2 35/38 x 10 mm. Recomd. housing bore: 38 mm.	

VARIOUS - Bearing Caps

802034

 130903 Qty. 3 Repl. 79058. Serv. A12M1, A12R11. 6200 bearing cap S.R.E. I.D. 30 mm. O.D. 33 mm. W. 13.25 mm.	 131826 Qty. 3 Repl. 105299, 590629. Serv. A14N... 6201 bearing cap S.R.E. I.D. 32 mm. O.D. 34 mm. W. 14 mm.	 131827 Qty. 3 Repl. 104809. Serv. A13N... 6200 bearing cap S.R.E. I.D. 30 mm. O.D. 31.7 mm. W. 13.4 mm.	 131828 Qty. 3 Repl. 1120 591 082, 77973. Serv. 0120 469..., A13R... 6201 bearing cap S.R.E. I.D. 32 mm. O.D. 35 mm. W. 15 mm.
 132769 Qty. 2 Repl. 1120 591 075. Serv. 6201, 140081. S.R.E. I.D. 34 mm. O.D. 35 mm. W. 42 mm.	 133648 Qty. 3 Serv. 294... 6200 bearing cap. I.D. 30 mm. O.D. 32.5 mm. W. 11.5 mm.	 135171 Qty. 3 Serv. A13VI... O.D. 34.3 mm. Alternators w/ internal fan.	 135407 Qty. 2 Repl. 1120 591 102, -116. Serv. 0120 335 006, -007, -011, -012.
 139681 OE Qty. 3 Repl. 0094.3701302. Serv. 2112-3701010, 9402.3701. I.D. 30 mm. O.D. 37.5 mm. W. 13.4 mm.	 135237 Qty. 3 Repl. 1120 591 076, -103. Serv. 0124 485 005, -006, -007, -008. I.D. 40 mm. O.D. 43 mm. W. 16.6 mm. Alternator w/ internal fan.	 135508 Qty. 3 Serv. A13VI... 6202 bearing cap. O.D. 37.3 mm.	 134428 Qty. 3 Serv. 1101551. 27 x 29.2 x 25.8 mm.
 136235 OE Qty. 3 Repl. 1120 591 060. Serv. 62201, 140105. I.D. 32 mm. O.D. 35 mm. W. 18.8 mm.	 139929 Qty. 2 Repl. F00M 146 900. Serv. 0124 215 001, -002, -003, -004, -005, 0124 220 002, 0124 225 001, -002, -004, -009, -013, -014, -015, -016, -019, -021, -022, -023, -024.	 139952 Qty. 3 Serv. A115 i. I.D. 35 mm. O.D. 37 mm. W. 14 mm.	 135170 Qty. 3 Serv. A11, 13VI... 6201 bearing cap. O.D. 32.8 mm. Alternators w/ internal fan.

802023 VARIOUS - Spacers for Pulleys - Alternators

 610063 Qty. 5 Bore: 15 mm. O.D.: 25 mm. Th: 1.5 mm.	 610034 Qty. 5 Bore: 15 mm. O.D.: 35 mm. Th: 9.2 mm. Key: 5 mm.	 610027 Qty. 5 Bore: 15 mm. O.D.: 30 mm. Th: 12 mm. Key: 5 mm.	 610033 Qty. 5 Bore: 15 mm. O.D.: 35 mm. Th: 2.7 mm. Key: 5 mm.	 134273 Qty. 5 Bore: 15.5 mm. O.D.: 21.6 mm. Th: 5.85 mm.
 610021 Qty. 5 Bore: 17 mm. O.D.: 45 mm. Th: 6.5 mm. Key: 5 mm.	 610022 Qty. 5 Bore: 17 mm. O.D.: 30 mm. Th: 17 mm. Key: 5 mm.	 610023 Qty. 5 Bore: 17 mm. O.D.: 25 mm. Th: 18 mm. Key: 5 mm.	 610024 Qty. 5 Bore: 17 mm. O.D.: 30 mm. Th: 8 mm. Key: 5 mm.	
 610025 Qty. 5 Bore: 17 mm. O.D.: 30 mm. Th: 12 mm. Key: 5 mm.	 610026 Qty. 5 Bore: 17 mm. O.D.: 25 mm. Th: 12 mm. Key: 5 mm.	 610028 Qty. 5 Bore: 17 mm. O.D.: 25 mm. Th: 16 mm. Key: 5 mm.	 610029 Qty. 5 Bore: 17 mm. O.D.: 30 mm. Th: 14.5 mm. Key: 5 mm.	 610030 Qty. 5 Bore: 17 mm. O.D.: 30 mm. Th: 6.5 mm. Key: 5 mm.
 610031 Qty. 5 Bore: 17 mm. O.D.: 25 mm. Th: 5.5 mm. Key: 5 mm.	 610032 Qty. 5 Bore: 17 mm. O.D.: 25 mm. Th: 3.5 mm. Key: 5 mm.	 610036 Qty. 5 Bore: 17 mm. O.D.: 35-25 mm. Th: 10.5 mm. Key: 5 mm.	 610040 Qty. 5 Bore: 17 mm. O.D.: 45 mm. Th: 2 mm. Key: 5 mm.	 610061 Qty. 5 Bore: 17 mm. O.D.: 45 mm. Th: 1 mm. Key: 5 mm.
 610062 Qty. 5 Bore: 17 mm. O.D.: 27 mm. Th: 1 mm.	 610041 Qty. 5 Bore: 17.5 mm. O.D.: 35 mm.			

802028 VARIOUS - Nuts & Keys - Alternators

 191298 Qty. 10 M14-1.5. Rotor shaft nut.	 191299 Qty. 10 Repl. LR150-1810. Serv. LR125-40, LR140-130P. M16-1.5. Rotor shaft nut.	 130819 Qty. 10 Repl. 198800. Serv. C40. Rotor shaft nut. 7/16" UNF.	 131822 Qty. 10 Rotor shaft nut, fine threaded.
 132080 Qty. 5 Serv. A529X04971 M17-1.5. Rotor shaft nut set.	 132346 Qty. 10 Repl. 1915172. Rotor shaft nut. M16-1.0.	 130910 Qty. 10 Serv. 15, 16, 17, 18ACR. Rotor shaft nut.	 133612 Qty. 10 Serv. A529X02171. M15-1.5. Rotor shaft nut set.
	 135049 Qty. 10 Repl. 54134696. Serv. A 127. Rotor shaft nut set.	 133784 Qty. 10 3 x 6.5 x 16 mm. Key.	 133785 Qty. 10 Repl. 1900 023 004. 3 x 3.7 x 10 mm.. Key.

O.E.M. names and numbers are used for reference purposes only.

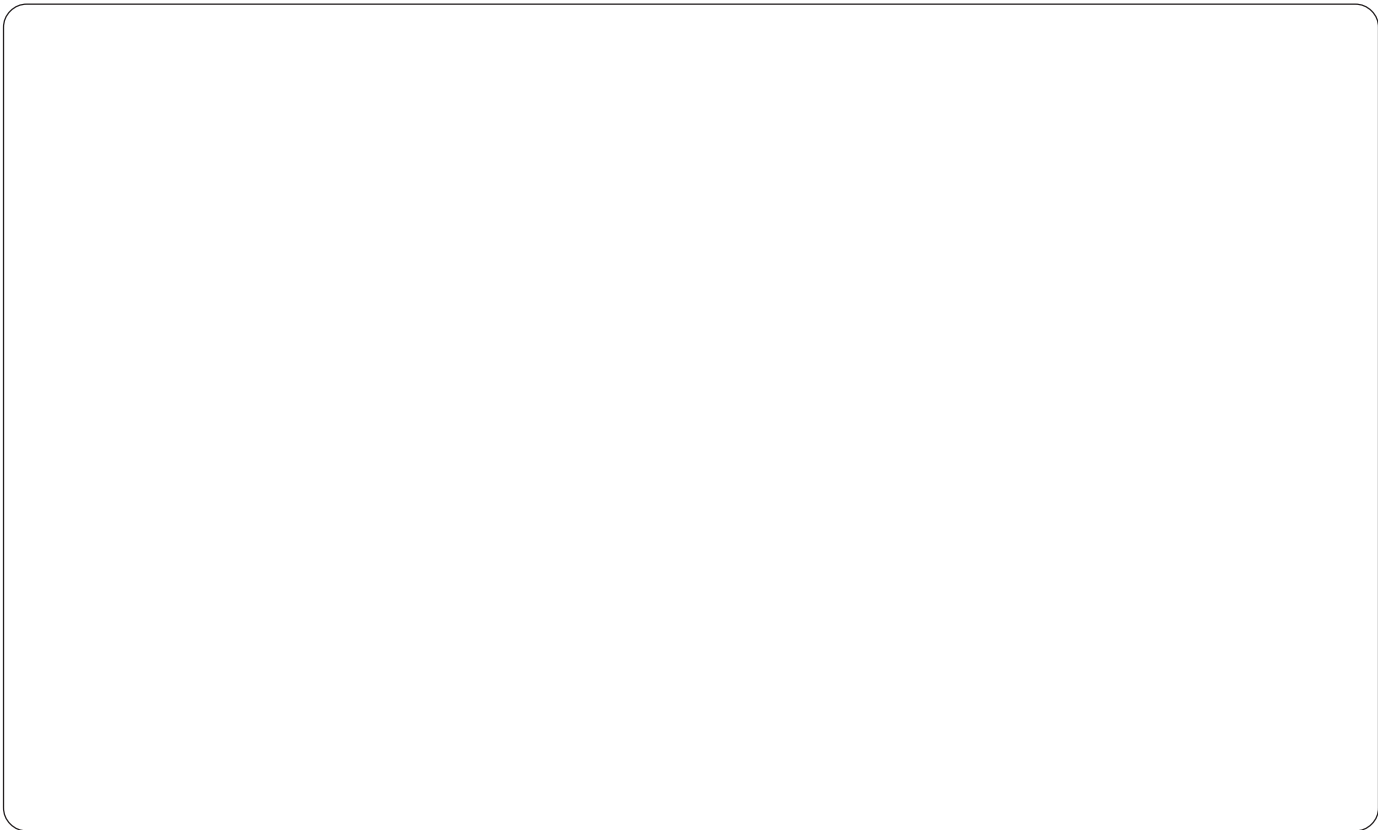
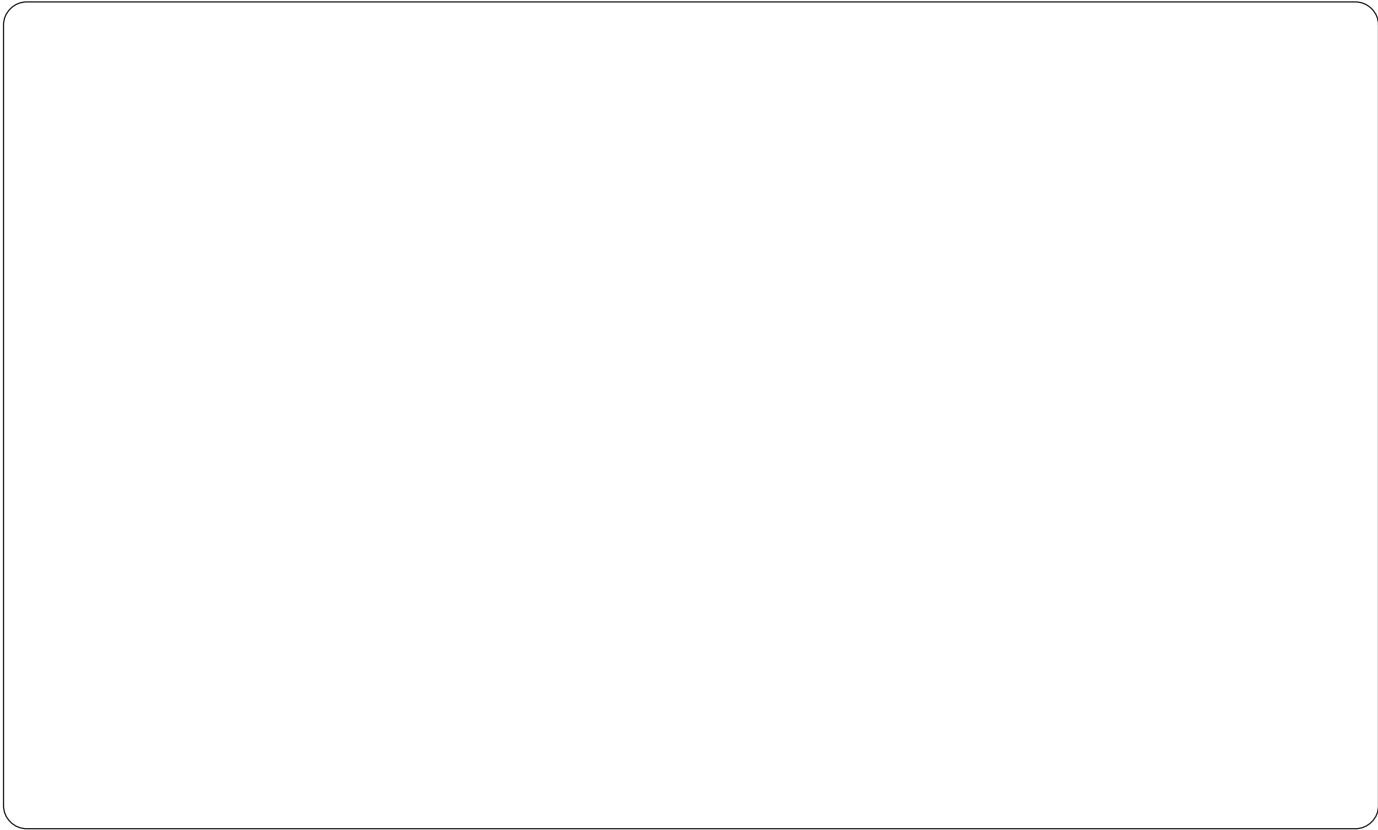



ASSORTMENTS

PART 3













Notes

A large, empty rectangular box with rounded corners, intended for writing notes.













803008 Gear Wheels Replacing BOSCH

 <p>131992 Qty. 1 Repl. 9001 140 322. Serv. 0001 218 001, -002, -003, -004, -006, -007. Outer gear, steel.</p>	 <p>132604 Qty. 1 Repl. 9001 140 322. Same as Cargo 131992, but in plastic.</p>	 <p>131503 Qty. 1 Repl. 1005 821 307. Serv. 0001 108 ... DCR 1.1 - 1.4 kW. 37 tooth, O.D. 69.8 mm. Outer gear.</p>	 <p>132123 Qty. 1 Repl. 1005 821 303. Serv. 0001 110 ... DCR 1.7 kW. 42 tooth, O.D. 74 mm. Outer gear.</p>
 <p>134516 Qty. 1 Serv. 1006 200 017, -903, Cargo 133483. 37 tooth, O.D. 57.7 mm, W. 10 mm. Gear wheel (Inside).</p>	 <p>134562 Qty. 1 Repl. 9003 336 321. Serv. 0001 218 ... 42 tooth, O.D. 63.5 mm, W. 13 mm. Gear wheel (Inside).</p>	 <p>133466 Qty. 1 Repl. 1005 821 308. Serv. 0001 108 003, -018, -042, -054, -063, -064. Gear wheel cover.</p>	 <p>133467 Qty. 1 Repl. 1005 821 306. Serv. 0001 110 016, -026, -028, -029, -030, -031. Gear wheel cover.</p>
 <p>134160 Qty. 1 Serv. 0001 218 ... Planet gear repair kit.</p>			

803009 Gear Parts Replacing BOSCH



















 <p>133468 Qty. 2 Serv. 0001 108 003, -018, -042, -054, -063, -064, 065, -074, -078, -079, -080, -083, -087, -088. Gear plate.</p>	 <p>133469 Qty. 2 Serv. 0001 110 016, -028, -029, -030, -031, -039, 041, -053, -054, -075. Gear plate.</p>	 <p>133470 Qty. 2 Serv. 0001 108 003, -018, -042, -054, -063, -064, 065, -074, -078, -079, -080, -083, -087, -088, -089. Gear ring.</p>	 <p>133471 Qty. 2 Serv. 0001 107... Gearing.</p>		
 <p>133475 Qty. 2 Serv. 1006 200 006, -018, Cargo 133459. Gear plate.</p>	 <p>133476 Qty. 2 Serv. 1006 200 006, -015, -021, Cargo 133456, 133457, 133458. Gear plate.</p>	 <p>133477 Qty. 9 Serv. 1006 200 017. 19.5 x 11.5 mm. Rubber for planet gear.</p>	 <p>133478 Qty. 9 Serv. 1006 200 019. 19.5 x 14.5 mm. Rubber for planet gear.</p>	 <p>134067 Qty. 10 Serv. 0001 108 ... 16 x 6 mm. Rivet.</p>	 <p>134068 Qty. 10 Serv. 0001 110 ... 19 x 6 mm. Rivet.</p>
		 <p>134032 Qty. 2 Serv. 0001 108 ... 13 tooth. Gear wheel kit. 19.3 / 6 x 8.5 mm.</p>	 <p>134035 Qty. 2 Serv. 0001 110 ... 13 tooth. Gear wheel kit. 19.3 / 6 x 10.5 mm.</p>	 <p>134066 Qty. 2 Serv. 0001 110 ... 12 tooth. Gear wheel kit. 17 / 5 x 10.5 mm.</p>	

Gear Reduction - Brushes & Holders Repl. BOSCH 803010

 <p>134658 Qty. 1 Repl. 1004 336 125, -907, -954. Serv. 0001 108 001, -004, -007, -009, -010, -011. W/ springs and brushes.</p>	 <p>134659 Qty. 1 Repl. 1004 336 958. Serv. 0001 110 001, -009, -014, -018, -033. W/ springs and brushes.</p>	 <p>134660 Qty. 1 Repl. 1004 336 909, -925, -955. Serv. 0001 110 004, -005, -012, -013, -017. W/ springs and brushes.</p>	 <p>134661 Qty. 1 Serv. 0001 218 ... W/ springs and brushes.</p>	
 <p>133553 Qty. 10 Serv. 0001 108 ... Brush holder.</p>	 <p>133555 Qty. 10 Serv. 0001 110 ... Brush holder.</p>	 <p>134702 Qty. 10 Serv. 0001 218 ... Brush holder.</p>	 <p>132576 Qty. 10 Serv. 0001 108 ... Gear reduction starters. Brush spring.</p>	 <p>133557 Qty. 10 Serv. 0001 110 ... Gear reduction starters. Brush spring.</p>
 <p>BSX151S 4 Qty. 4 Repl. 1007 014 143. Serv. 0001 218 ... Gear reduction starters. 12 V. 7.5 x 18 x 19 mm. 2 component brushes.</p>	 <p>BSX157-158 4 Qty. 4 Serv. DCR 1.7 kW. 0001 110 ... Gear reduction starters. 12 V. 6 x 18 x 14 mm. Permanent magnet. 2 component brushes.</p>	 <p>BSX159-160 4 Qty. 4 Serv. DCR 1.1, 1.4 kW., 0001 108 ... Gear reduction starters. 12 V. 5 x 16 x 13 mm. Permanent magnet. 2 component brushes.</p>	 <p>BSX175-176 4 Qty. 4 Serv. 0001 107 ..., 0001 112 ..., 0001 113 ..., 0001 114 ... Latest model. 12 V. 5 x 12 x 11.6 mm.</p>	

Brushes 12 V. Replacing BOSCH

803018

 <p>BSX12 4 Qty. 2 Repl. 1007 014 100. 6 / 12 V. 9 x 13 x 25.5 mm.</p>	 <p>BSX75 4 Qty. 2 Repl. 2007 014 026. 12 V. 7 x 10 x 18 mm.</p>	 <p>BSX76 4 Qty. 2 Repl. 1007 014 121. 12 V. 7 x 16 x 18 mm.</p>	 <p>BSX96 4 Qty. 2 Repl. 2007 014 052, -566. 12 V. 10 x 25 x 23 mm.</p>		
 <p>BSX97F 4 Qty. 2 Repl. 2007 014 057. 12 V. 9 x 16 x 17 mm. W/ leader.</p>	 <p>BSX98F 4 Qty. 2 Repl. 1007 014 126. 12 V. 7 x 10 x 18 mm. W/ leader.</p>	 <p>BSX102 4 Qty. 2 Repl. 2007 014 053. 12 V. 9 x 16 x 25.5 mm.</p>	 <p>BSX104 4 Qty. 2 Repl. 2007 014 054. 12 V. 7 x 16 x 18 mm.</p>		
 <p>BSX124F 4 Qty. 2 Repl. 1007 014 129. 12 V. 7 x 16 x 18 mm. W/ leader.</p>	 <p>BSX134-144 4 Qty. 2 Repl. 2007 014 062. 12 V. 10 x 25 x 17 mm.</p>	 <p>BSX137-143 4 Qty. 2 Repl. 2007 014 068. 12 V. 9 x 16 x 17 mm.</p>	 <p>BSX139 4 Qty. 2 Repl. 2007 014 065. 12 V. 9 x 16 x 17 mm.</p>		
 <p>BSX140 4 Qty. 2 Repl. 1007 014 138. 12 V. 7 x 16 x 15 mm.</p>	 <p>BSX149 4 Qty. 2 Repl. 1007 014 105. 12 V. 7 x 10 x 14 mm.</p>	 <p>BSX151S 4 Qty. 2 Repl. 1007 014 143. Serv. 0001 218 ... Gear reduction starters. 12 V. 7.5 x 18 x 19 mm. 2 component brushes.</p>	 <p>BSX157-158 4 Qty. 2 Serv. DCR 1.7 kW. 12 V. 6 x 18 x 13 mm. 2 component brushes.</p>	 <p>BSX159-160 4 Qty. 2 Serv. DCR 1.1, 1.4 kW. 12 V. 5 x 16 x 13 mm. 2 component brushes.</p>	 <p>BSX175-176 4 Qty. 2 Serv. 0001 107 ..., 0001 112 ... Latest model 12 V. 5 x 12 x 11.6 mm.</p>

803017 Brushes 24 V. Replacing BOSCH

 <p>BSX34 4 Qty. 2 Repl. 1007 014 107. 24 V. 9 x 20 x 28.5 mm.</p>	 <p>BSX100 4 Qty. 2 Repl. 2007 014 049. 24 V. 8 x 25 x 23 mm.</p>	 <p>BSX103 4 Qty. 2 Repl. 2007 014 017. 24 V. 12 x 40 x 27 mm.</p>	 <p>BSX116F 4 Qty. 2 Repl. 2007 014 058. 24 V. 9 x 16 x 15.5 mm. (W/leader).</p>
 <p>BSX93 4 Qty. 2 Repl. 2007 014 016. 24 V. 9 x 16 x 25.5 mm.</p>	 <p>BSX135-145 4 Qty. 2 Repl. 2007 014 063. 24 V. 8 x 25 x 17 mm.</p>	 <p>BSX147 4 Qty. 2 Repl. 2007 014 067. 24 V. 10 x 36 x 27 mm.</p>	 <p>BSX148 4 Qty. 2 Repl. 2007 014 070. 24 V. 12 x 36 x 27 mm.</p>
 <p>BSX131 4 Qty. 2 Repl. 2007 014 061. 24 V. 12 x 36 x 27 mm.</p>	 <p>BSX135-145 4 Qty. 2 Repl. 2007 014 063. 24 V. 8 x 25 x 17 mm.</p>	 <p>BSX147 4 Qty. 2 Repl. 2007 014 067. 24 V. 10 x 36 x 27 mm.</p>	 <p>BSX148 4 Qty. 2 Repl. 2007 014 070. 24 V. 12 x 36 x 27 mm.</p>

803012 Bushings Replacing BOSCH

 <p>140003 Qty. 10 Repl. 1000 301 001. 12.57 x 16.56 x 11.5 mm.</p>	 <p>140004 Qty. 10 Repl. 2000 301 009. 14.8 x 17.58 x 15 mm.</p>	 <p>140008 Qty. 10 Repl. 1000 301 021. 11.07 x 13.6 x 14 mm.</p>	 <p>140009 Qty. 10 Repl. 1000 301 011. 12.07 x 16.12 x 16 mm.</p>	 <p>140010 Qty. 10 Repl. 2000 301 000. 12.57 x 16.56 x 18 mm.</p>	 <p>140016 Qty. 10 Repl. 1000 301 000. 12.57 x 16.55 x 15.8 mm.</p>	 <p>140017 Qty. 10 Repl. 1000 301 012. 12.06 x 16.11 x 14 mm.</p>	 <p>140018 Qty. 10 Repl. 2000 301 036. 12.12 x 14.11 x 13.8 mm.</p>
 <p>140019 Qty. 10 Repl. 2000 301 043. 14.06 x 18.03 x 14 mm.</p>	 <p>140020 Qty. 5 Repl. 2000 301 002. 19.13 x 25.09 x 10 mm.</p>	 <p>140012 Qty. 10 Repl. 1000 301 002. 12.56 x 16.55 x 14 mm.</p>	 <p>140025 Qty. 10 Repl. 2000 301 026. 19.11 x 23.08 x 9.8 mm.</p>	 <p>140026 Qty. 5 Repl. 2000 301 041. 19.1 x 23.1 x 13 mm.</p>	 <p>140027 Qty. 10 Repl. 1000 301 022. 17.65 x 21.6 x 9.5 mm.</p>	 <p>140028 Qty. 10 Repl. 2000 301 022. 11.1 x 12.6 x 10.5 mm.</p>	 <p>140029 Qty. 10 Repl. 1000 301 026. 12.1 x 13.6 x 13.5 mm.</p>
 <p>140030 Qty. 10 Repl. 1000 301 009. 12.1 x 13.62 x 11.5 mm.</p>	 <p>140035 Qty. 10 Repl. 1000 301 023. 14.36 x 16.02 x 10 mm.</p>	 <p>140140 Qty. 5 Repl. 2000 301 004. 16.67 x 19.6 x 19 mm.</p>	 <p>140151 Qty. 5 Repl. 2000 301 011. 19.12 x 25.1 x 12.8 mm.</p>	 <p>140203 Qty. 5 Repl. 2000 301 037. 14.08 x 20.03 x 17 mm.</p>	 <p>140204 Qty. 10 Repl. 9001 140 347. Serv. 0001 218 ... 10.05 x 16.55 x 11.5 mm.</p>	 <p>140208 Qty. 10 Repl. 1000 301 056. Serv. 0001 108 ... 10.08 x 14.04 x 9.9 mm.</p>	 <p>140249 Qty. 10 Repl. 1000 301 054. Serv. 0001 108 ... 8.09 x 11.12 x 8 mm.</p>
 <p>140250 Qty. 10 Serv. 0001 218 ... 8.09 x 11.12 x 10 mm. Gear inside.</p>	 <p>140251 Qty. 10 Repl. 1000 301 055. Serv. 0001 108 ... 18 x 22.1 x 8 mm.</p>	 <p>140252 Qty. 10 Serv. 0001 218 ... 18 x 22.1 x 8 mm. Gear outside.</p>	 <p>140261 Qty. 10 Repl. 1000 301 003. 14.36 x 16.03 x 18 mm.</p>	 <p>140423 Qty. 10 12.55 x 16.56 x 9.9 mm.</p>	 <p>140500 Qty. 10 Repl. 2000 301 023. 12.11 x 14.1 x 12 mm.</p>	 <p>140563 Qty. 10 Repl. 1000 322 005. 10.04 x 16.55 x 18.7 x 1.5 x 14.7 mm.</p>	 <p>140645 Qty. 10 Repl. 1000 301 010. 12.63 x 14.1 x 10.5 mm.</p>

Starter Parts for FKB Replacing BOSCH

803011



















<p>131841 Qty. 5 Repl. 1902 300 090. Serv. FKB. Key for drive.</p>	<p>131445 Qty. 5 Repl. 2000 105 040. Serv. FKB. 41 x 58.6 x 0.7 mm. Clutch-washer.</p>	<p>131453 Qty. 2 Repl. 2000 102 622. Serv. FKB. Washer kit.</p>	<p>131448 Qty. 4 Repl. 2000 283 013. Serv. FKB. 33 / 45 x 7 mm.</p>	<p>131449 Qty. 5 Repl. 2000 212 000. Serv. FKB. Dust seal.</p>	<p>131450 Qty. 5 Repl. 2004 650 030. Serv. FKB. For Cargo 131449.</p>	<p>134525 Qty. 2 Serv. FKB. Adaptor. From M12 to M10. B terminal.</p>
<p>131447 Qty. 5 Repl. FKB, 2911 061 301. M10 x 51 mm. Terminal 31.</p>	<p>133604 Qty. 1 Repl. 2007 011 060. Serv. FKB. For M12 terminal 30, Cargo 133603. For M10 terminal 31, Cargo 131447. Terminal kit.</p>		<p>131499 Qty. 10 Repl. 2004 652 006. Serv. FKB. Brush spring.</p>	<p>131444 Qty. 2 Repl. 2000 210 014. Serv. FKB. Gasket for cover.</p>	<p>134156 Qty. 10 Serv. FKB. Metal plate for negative brush holder.</p>	<p>134324 Qty. 10 Serv. FKB. Insulator for brush holder.</p>
<p>138927 Qty. 1 Repl. 2004 632 026. Serv. FKB, 0001 410 088, 0001 411 012. Terminal 30. M10. Earthed. Waterproof. Terminal kit.</p>	<p>140197 Qty. 2 Repl. 2000 910 013. Serv. 0001 410 . . . 18 / 24 x 16 mm.</p>	<p>140198 Qty. 2 Repl. 2000 910 005. Serv. 0001 410 . . . 34 / 48 x 15 mm.</p>	<p>140011 Qty. 2 Repl. 2000 301 015. 40.12 x 48.04 x 10.50 mm</p>	<p>140111 Qty. 2 Repl. 2000 301 016. 22.14 x 28.07 x 11.20 mm</p>		
<p>133308 Qty. 1 Serv. FKB, 0001 416 001, -014, -018. Terminal 30. M10. Terminal 31. M10 insulated. Terminal kit.</p>	<p>BSX131 4 Qty. 1 Repl. 2007 014 061. 24 V. 12 x 36 x 27 mm.</p>		<p>BSX148 4 Qty. 1 Repl. 2007 014 070. 24 V. 12 x 36 x 27 mm.</p>			

Bushings Replacing DELCO US









803014

<p>140070 Qty. 5 Repl. 38273, 1894636. Serv. 40 MT. 14.3 x 19.2 x 24.6 mm. C.E.</p>	<p>140071 Qty. 5 Repl. 1943628. Serv. 35 MT, 40 MT. 14.3 x 19.1 x 19.1 mm. D.E.</p>	<p>140072 Qty. 5 Repl. 1923484. Serv. 40 MT. 21 x 24.5 x 28.6 mm. I.M.</p>	<p>140074 Qty. 5 Repl. 1945509. Serv. 40 MT, 50 MT. 16 x 19.2 x 22 mm. D.E.</p>	<p>140944 Qty. 5 Repl. 1957017. Serv. 8 MT, 10 MT, 25 MT. 19.2 x 20.74 x 9.5 mm. I.M.</p>	
<p>140776 Qty. 5 Repl. 1894023. Serv. 10 MT, 20 MT, 22 MT, 25 MT, 27 MT. 19.33 x 22.3 x 18.34 mm. I.M.</p>	<p>140181 Qty. 5 Repl. 810620. Serv. 5 MT, 8 MT. 14.3 x 15.9 x 19 mm. C.E.</p>	<p>140182 Qty. 5 Repl. 820148. Serv. 25 MT. 19.05 x 20.65 x 18.25 mm. D.E.</p>	<p>140183 Qty. 5 Repl. 1932190. Serv. 5 MT, 10 MT. 12 x 13.2 x 12.6 mm. D.E.</p>	<p>140184 Qty. 5 Repl. 810620. Serv. 5 MT. Split type. 14.3 x 15.9 x 19 mm. C.E.</p>	<p>140185 Qty. 5 Repl. 1839345. Serv. 25 MT, 27 MT. 12.7 x 14.3 x 19.8 mm. D.E.</p>
<p>140206 Qty. 5 Repl. 1988096. Serv. 42 MT. 22.6 x 24.4 x 25 mm. I.M.</p>	<p>140214 Qty. 5 Repl. 1985234. Serv. 37 MT. 22.55 x 25.68 x 24.9 mm. I.M.</p>	<p>140215 Qty. 5 Repl. 1891927. Serv. 35 MT. 14.35 x 17.55 x 19.9 mm. C.E.</p>	<p>140217 Qty. 5 Repl. 1862383. Serv. 20 MT, 1998339. 12.7 x 15.95 x 20.62 mm. D.E.</p>	<p>140404 Qty. 5 Repl. 1962606. Serv. 10 MT, 20 MT. 19.02 x 31.75 x 10.2 mm. I.M.</p>	
<p>140405 Qty. 10 Repl. 1923907. Serv. 8 MT. Split type. 1207 x 1325 x 1816 mm. D.E.</p>	<p>140406 Qty. 10 Repl. 1933999. Serv. 30 MT, 35 MT. 18.7 x 22.6 x 19.4 mm. I.M.</p>	<p>140477 Qty. 5 Repl. 1894637. Serv. 50 MT. 21.3 x 24.5 x 31.7 mm. I.M.</p>	<p>140478 Qty. 5 Repl. 1869755, 1894638. Serv. 50 MT. 17.5 x 22.35 x 28.4 mm. C.E.</p>	<p>140601 Qty. 10 Repl. 10456459. Serv. 28 MT. 14 x 17 x 16.1 mm. D.E.</p>	

803015 Starter Parts Replacing DELCO US

 <p>132877 Qty. 1 Repl. 1962601, 1987373. Serv. 10 MT, 20 MT, 25 MT, 27 MT. Plunger boot.</p>		 <p>133461 Qty. 1 Repl. 801077. Serv. 30 MT, 40 MT. Plunger boot.</p>		 <p>134429 Qty. 1 Repl. 1985243. Serv. 37 MT, 41 MT, 42 MT. Plunger boot.</p>		 <p>132730 Qty. 1 Repl. 1893929. Serv. 5 MT. Complete w/ brushes.</p>		
 <p>132113 Qty. 5 Repl. 1926618. Serv. 30 MT. Brush holder.</p>	 <p>132114 Qty. 5 Repl. 1893293. Serv. 5 MT. Brush holder.</p>	 <p>131406 Qty. 4 Repl. 8 MT, 10 MT, 20 MT, 22 MT, 25 MT, 27 MT. Brush holder kit.</p>		 <p>132115 Qty. 10 Serv. 5 MT. Brush spring.</p>	 <p>132116 Qty. 10 Repl. 1986019. Serv. 25 MT, 27 MT. Brush spring.</p>	 <p>132131 Qty. 10 Repl. 1945620. Serv. 30 MT. Brush spring.</p>	 <p>134843 Qty. 10 Repl. 10456460. Serv. 28 MT. Brush spring.</p>	
 <p>131410 Qty. 5 Serv. 25 MT, 27 MT. Stop collar kit.</p>		 <p>131442 Qty. 5 Serv. 5 MT, 8 MT. Stop collar kit.</p>		 <p>132382 Qty. 5 Repl. 1918047. Serv. 40 MT, 42 MT. 19.45 / 34.81 x 9.55 mm</p>	 <p>132682 Qty. 5 Repl. 1867150. Serv. 30 MT. 17.46 / 34.8 x 6.35 mm</p>	 <p>133023 Qty. 10 Repl. 9417501. Serv. 40 MT, 50 MT. 1 1/32". Plug.</p>	 <p>133024 Qty. 10 Repl. 1949619. Serv. 30 MT, 40 MT. Plug.</p>	 <p>133027 Qty. 5 Repl. 1962603. Serv. 10 MT, 20 MT, 22 MT, 25 MT, 27 MT. Gasket, center plate.</p>
 <p>133025 Qty. 10 Repl. 9419572. Serv. 30 MT. 5/8". Plug.</p>	 <p>133026 Qty. 10 Repl. 9411375. Serv. 30 MT, 35 MT. 1 3/16". Plug.</p>	 <p>134665 Qty. 10 Repl. 1955303. Serv. 40 MT, 50 MT. O.D. 7/8". Felt plug.</p>		 <p>133974 Qty. 5 Serv. 28 MT. O.D. 82 mm. I.D. 79 mm. Gasket for I.M. bracket.</p>				

803016 Brushes Replacing DELCO US

 <p>RX60 4 Qty. 5 Repl. 1906945. Serv. 5 MT, 8 MT, 10 MT. 12 V. 6.3 x 19.05 x 16 mm.</p>		 <p>RX70 8 Qty. 2 Repl. 1906986. Serv. 40 MT. 24 V. 9.5 x 19.05 x 19 mm.</p>		 <p>RX92 12 Qty. 2 Repl. 1906989. Serv. 50 MT. 24 V. 7.9 x 19.05 x 19 mm.</p>		 <p>RX87 4 Qty. 5 Repl. 1906958. Serv. 30 MT, 35 MT. 12 V. 9.5 x 19.05 x 19 mm.</p>	
 <p>RX122H4 Qty. 2 Repl. 1852883. Serv. 40 MT, 400, 450. 24 V. 9.5 x 38 x 21 mm.</p>		 <p>RX108 4 Qty. 5 Repl. 1893296. Serv. 5 MT. 12 V. 6.35 x 15.9 x 13.5 mm. (1/4" x 5/8" x 17/32").</p>		 <p>RX124H 6 Qty. 2 Repl. 1852888. Serv. 50 MT, 400 24 V. 7.95 x 38.1 x 20.65, (5/16" x 1 1/2" x 13/16").</p>		 <p>RX95 4 Qty. 2 Repl. 1946434. Serv. 25 MT. 6 / 12 V. 9.5 x 19.05 x 19 mm.</p>	
 <p>RX121 4 Qty. 5 Repl. 1852880. Serv. 25 MT. 12 V. 7.95 x 19.05 x 19.05 mm.</p>		 <p>RX134H4 Qty. 2 Repl. 1852894. Serv. 42 MT. 24 V. 10.5 x 36.5 x 24.2 mm.</p>					

Brushes Replacing DUCELLIER

803037

 <p>140849 Qty. 2 Repl. 618491. 12 V. 8 x 15 x 15 mm. W/o springs: Cargo USX73-85 2.</p>	 <p>USX50-51 2 Qty. 2 Repl. 79325. 6/12 V. 8.8 x 19.05 x 13 mm.</p>	 <p>USX50-51 4 Qty. 2 Repl. 618509. 6/12 V. 8.8 x 19.05 x 13 mm.</p>	 <p>USX68 2 Qty. 2 Repl. 618570. 12 V. 8 x 15 x 15 mm.</p>
 <p>USX73-85 2 Qty. 2 Repl. 618491. 12 V. 8 x 15 x 15 mm.</p>	 <p>USX76-77-78 Qty. 2 Repl. 618539. 12 V. 8 x 15 x 15 mm.</p>	 <p>USX91-92 2 Qty. 2 Repl. 583041, 618692. 12 V. 6 / 11.7 x 13 x 15 mm.</p>	 <p>USX93-94 2+1 Qty. 2 Repl. 583241. 12 V. 5.5 / 8.2 x 13.1 x 15 / 18.5 mm.</p>

Bushings Replacing DUCELLIER

803019

 <p>140038 Qty. 10 Repl. 98888. 10.07 x 13.05 x 12 mm.</p>	 <p>140040 Qty. 10 Repl. 68412. 12.09 x 15.05 x 12 mm.</p>	 <p>140041 Qty. 10 Repl. 600664. 13.05 x 15.07 x 18 x 1.5 x 13.5 mm.</p>	 <p>140042 Qty. 10 Repl. 600609. 13.04 x 15.05 x 14.5 mm.</p>	 <p>140043 Qty. 10 Repl. 68430. 12.07 x 15.05 x 15 mm.</p>	 <p>140064 Qty. 10 Repl. 82775. 12.07 x 15.05 x 20 mm.</p>	 <p>140157 Qty. 10 Repl. 602039. 13.04 x 15.05 x 12 mm.</p>	 <p>140257 Qty. 10 Repl. 94909. 15.95 x 19.15 x 14 mm.</p>
 <p>140264 Qty. 10 Repl. 28936. 16.27 x 19.15 x 15 mm.</p>	 <p>140267 Qty. 10 Repl. 68754. 14.1 x 17.05 x 15 mm.</p>	 <p>140621 Qty. 10 12.05 x 13.12 x 16 mm.</p>	 <p>140622 Qty. 10 11.76 x 13.42 x 11.24 mm.</p>	 <p>140623 Qty. 10 13.05 x 13.72 x 20 mm.</p>	 <p>140667 Qty. 10 Repl. 068763. 14.05 x 18.05 x 15 mm.</p>		
 <p>140533 Qty. 5 Repl. 583348, 182063. 2 bushes. 12.09 x 15.0 x 12 mm, 12.09 x 15.0 x 12 mm.</p>	 <p>140543 Qty. 5 Repl. 583372. 3 bushes. 12.09 x 15.05 x 12 mm. 14.05 x 18.05 x 15 mm, 16.27 x 19.15 x 15.2 mm.</p>	 <p>140544 Qty. 5 Repl. 583376. 3 bushes. 12.09 x 15.05 x 12 mm. 13.04 x 15.05 x 12 mm, 14.1 x 17.05 x 15 mm.</p>	 <p>140545 Qty. 5 Repl. 583379. 3 bushes. 14.1 x 17.05 x 15 mm (2 pcs.). 16.27 x 19.15 x 15.2 mm.</p>				

803021 Brushes Replacing LADA / MAGNETI MARELLI

 JSX5 2 Qty. 2 Repl. 4259228. 12 V. 6 x 16 x 17 mm.	 JSX9 4 Qty. 2 Repl. 853160. 24 V. 6.5 x 14 x 20 mm.	 JSX13 4 Qty. 2 Repl. 4475185. 12 V. 7 x 16 x 20 mm.	 JSX16 2 Qty. 2 Repl. 4255496. 12 V. 8 x 17 x 19 mm.	 JSX18 4 Qty. 2 Repl. 4174892, 748 387 01. 12 V. Serv. M125. 24 V. 10 x 22 x 28 mm.	 JSX19 4 Qty. 2 Repl. 4185547. 12 V. 10 x 22 x 28 mm.
 JSX21-22 Qty. 2 Repl. 748 811 51. 12 V. 6 x 13 x 17.5 mm.	 JSX23-24-28 Qty. 2 Serv. E100. 12 V. 7 x 15.5 x 20 mm.		 JSX31-32 Qty. 2 Repl. 7489438 / 1, 7489439 / 1. 12 V. 8 x 19 x 18 mm.	 JSX33-34 4 Qty. 2 Repl. 832 220 401. Serv. E70R. 12 V. 6 x 15 x 16.7 mm.	 JSX35-36 4 Qty. 2 Serv. E80-1/12. 12 V. 7 x 13 x 17.5 mm.
 JSX35-37 4 Serv. 632 228 3. 12 V. 7 x 13 x 17.5 mm. Qty. 2	 MASX13-14 4 Qty. 2 Repl. 9927791 / 92. 24 V. 8 x 25 x 23 mm.		 MASX15-16 4 Qty. 2 Repl. 9929080. 12 V. 10 x 25 x 23 mm.	 MASX17-18 4 Qty. 2 Repl. 9935196 / 97. 12 V. 9 x 16 x 23 mm.	
 MASX19-20 4 Qty. 2. Repl. 723 837 03 / 04. 24 V. 9 x 16 x 23 mm.	 MASX21-22 4 Qty. 2 Repl. 721 624 01 / 02. 24 V. 8 x 25 x 23 mm.	 MASX23-24 4 Qty. 2 Repl. 721 647 01, 621 658 01. 12 V. 10 x 25 x 23 mm.	 MASX25-26 4 Qty. 2 Repl. 721 641 01 Serv. MT71AB, DB. 12 V. 9 x 16 x 23.5 mm.	 MASX27-28 4 Qty. 2 Repl. 721 641 02, 721 657 01. Serv. MT72AB. 24 V. 9 x 16 x 23.5 mm.	

803020 Bushings Replacing LADA / MAGNETI MARELLI

 140009 Qty. 10 Serv. Samara. 12.07 x 16.12 x 16 mm. C.E.	 140043 Qty. 10 Serv. Samara. 12.07 x 15.05 x 15 mm. C.E.	 140046 Qty. 10 Repl. 4007952. 12.07 x 16.01 x 16.30 mm.	 140047 Qty. 10 Repl. 4114442. 10.08 x 14.02 x 15 mm.	 140048 Qty. 10 Repl. 4114431. 12.06 x 16.01 x 14 mm.	 140049 Qty. 10 Repl. 4047985. 12.11 x 16.01 x 24 mm.	 140050 Qty. 10 Repl. 672541. 10.08 x 14.02 x 13.5 mm.	
 140109 Qty. 5 Repl. 4169942. 16.19 x 22 x 19 mm.	 140110 Qty. 5 Repl. 4169954. 16.30 x 22 x 29 mm.	 140174 Qty. 5 Repl. 4073385, 747 340 10. 16.17 x 21 x 34.8 mm.	 140200 Qty. 5 Repl. 9927787. Serv. MT67, -68, -71. 12.59 x 18.55 x 19.60 mm.	 140201 Qty. 5 Repl. 9927796. Serv. MT67, -68, -71. 20.31 x 24 x 13.90 mm.			
 140202 Qty. 10 Repl. 9927783. Serv. MT67, -68, -71. 14.16 x 20.06 x 12 mm.	 140211 Qty. 5 Repl. 4073396, 747 982 10. 18.13 x 24.02 x 28 mm.	 140221 Qty. 10 Repl. 850211, 749 059 10. Serv. E115 3 / 24. Drive. 16.13 x 18 x 22 mm.	 140268 Qty. 10 Repl. 748 811 10. 12.06 x 16 x 12 mm.	 140269 Qty. 10 Repl. 748 873 10. 12.03 x 16.02 x 17 mm.	 140270 Qty. 10 Repl. 748 878 90. 12.07 x 16.02 x 11.30 mm.		
 140314 Qty. 10 Serv. Gear reduction starters. 11.04 x 15.08 x 15 mm.	 140374 Qty. 5 Repl. 2108-3708405. 12.06 x 16 x 23.8 x 19.5 mm. C.E.	 140614 Qty. 10 Serv. E95R. 15.07 x 18.1 x 11.8 mm.	 140626 Qty. 5 14.08 x 15 x 25.5 mm.	 140653 Qty. 10 Serv. E70R. 8 x 12 x 9.6 mm.	 140654 Qty. 10 Serv. E70R. Cargo 135712. 18.05 x 23.04 x 8.0 mm.	 140690 Qty. 10 11.5 x 13.5 x 23 mm.	 140710 Qty. 10 Serv. E70R. 18.04 x 23 x 7.25.

Brushes Replacing HITACHI

803023

 140334 Qty. 2 Repl. 2114-8312, 23379-16E01. 12 V. 7 x 11 x 18 mm.	 140335 Qty. 2 Repl. 2114-1315, 23331-43600. 12 V. 6.5 x 19 x 17 mm.	 140336 Qty. 2 Repl. 2114-2315. 12 V. 7 x 11 x 16 mm.	 140337 Qty. 2 Repl. 2250-2323. 12 V. 9 x 19.5 x 19 mm.
 140338 Qty. 2 Repl. 2114-1316, 23379-M4900. 12 V. 7 x 14 x 16 mm.	 140339 Qty. 2 Repl. 2120-7312, 23379-G7000. 12 V. 8 x 14.5 x 22 mm.	 140340 Qty. 2 Repl. 2108-2305, 23379-09900. 12 V. 6 x 16 x 14 mm.	 140341 Qty. 2 Repl. 2114-6312. 12 V. 7 x 16 x 16 mm.
 140376 Qty. 2 Repl. 2120-5312, 23379-65000. 12 V. 8 x 14.5 x 22 mm.	 140377 Qty. 2 Repl. 2120-6312/8311, 5 81119 0150. 12 V. 9 x 19.5 x 20 mm.	 140378 Qty. 2 Repl. 2130-5312, 23331-Z9002. 12 V. 8 x 25 x 18 mm.	 140379 Qty. 2 Repl. 2130-3315, -7312, -13111. 12 V. 7 x 19 x 15.5 mm.
	 140567 Qty. 2 Repl. 2130-23112, 23380-10G00. 12 V. 7 x 19 x 16 mm.	 140595 Qty. 2 Repl. 2130-1312, 23379-61501. 12 V. 9 x 19.5 x 22 mm.	 140597 Qty. 2 Repl. 2130-6312, -9311. 12 V. 8 x 19 x 18 mm.

Bushings Replacing HITACHI

803002

 140305 Qty. 10 Repl. 2114-1661, 23319-10600. 13 x 16.2 x 18.5 mm.	 140306 Qty. 10 Repl. 2114-1452. 17.5 x 20.1 x 7.5 mm.	 140307 Qty. 10 Repl. 2114-1605, 23319-43600. 12 x 16.3 x 22.5 mm.	 140308 Qty. 10 Repl. 2114-2302, 23338-85060. 13.8 x 19.2 x 20 mm.	 140309 Qty. 10 Repl. 2106-1601. 11.55 x 15.08 x 14 mm.
 140310 Qty. 10 Repl. 2114-4661. 12.52 x 16 x 15 mm.	 140311 Qty. 10 Repl. 2114-5352. 12.5 x 16.05 x 12 mm.	 140312 Qty. 10 Repl. 2608-8401, 23441-43600. 28.3 x 35.7 x 10 mm.	 140313 Qty. 10 Repl. 2130-1310, 23338-61503. 14 x 18 x 17 mm.	 140314 Qty. 10 Repl. 2114-3601. 11.04 x 15.08 x 15 mm.
 140316 Qty. 10 Repl. 2120-2601, 23319-37502. 14 x 18 x 20 mm.	 140317 Qty. 10 Repl. 2120-4401, 23441-37501. 20.35 x 26.5 x 12.5 mm.	 140318 Qty. 10 Repl. 2120-4302, 23338-37502. 15.03 x 20 x 16 mm.	 140489 Qty. 10 Repl. 2250-3601, 23319-29000. Serv. S25-156, 23300-C8601. 16 x 21.1 x 17 mm.	
 140572 Qty. 10 27.14 x 31.14 x 5.8 mm Bushing for gear reduction clutch.	 140573 Qty. 10 27.12 x 31.23 x 31.40 x 2.20 x 5.80 mm. Bushing for gear reduction clutch.	 140580 Qty. 10 13.1 x 14.5 x 18.5 mm.	 140584 Qty. 10 12.62 x 14 x 19.3 mm.	 140618 Qty. 10 13 x 16 x 18.5 mm.

803022 Starter Parts Replacing HITACHI

<p>140222 Qty. 5 Repl. 2114-15502. Serv. Gear reduction starters. 8 / 22 x 7 mm.</p>	<p>140223 Qty. 5 Repl. 2114-45502. Serv. Gear reduction starters. 20 / 42 x 12 mm.</p>	<p>140225 Qty. 5 Repl. 2114-25502. Serv. Gear reduction starters. 17 / 30 x 7 mm.</p>	<p>140226 Qty. 5 Repl. 2114-35505. Serv. Gear reduction starters. 20 / 37 x 9 mm.</p>
<p>140227 Qty. 5 Repl. 2130-3302. Serv. Gear reduction starters. 25 / 42 x 9 mm.</p>	<p>140381 Qty. 5 Repl. HK 2212. 22 / 28 x 12 mm.</p>	<p>140457 Qty. 5 Repl. HK 2012. 20 / 26 x 12 mm.</p>	<p>133731 Qty. 10 Repl. 2130-6313, 23333-10G00. Serv. S13-62B, -64, -66A, -69, -70A, -71, -75. Brush spring.</p>
<p>134739 Qty. 5 Repl. 2114-2657. Serv. S114-269, -305, -340. Spring for lever.</p>	<p>134740 Qty. 5 Repl. 2114-7657. Serv. S114-396. Spring for lever.</p>	<p>132847 Qty. 5 Repl. 2250-6105, 23369-29000. Serv. S12-48, S25-64, -74, -106A, -128, -129C. Stop collar kit.</p>	<p>133607 Qty. 5 Repl. 2114-3155. Serv. S12-19C, -24A. Stop collar kit.</p>
<p>133609 Qty. 5 Repl. 2114-3158. Serv. S114-146, -160F, -161F. Stop collar kit.</p>	<p>133611 Qty. 5 Repl. 2114-29006. Serv. S13-71, -75, -82A. Stop collar kit.</p>	<p>132104 Qty. 5 Serv. S13-84. Thermo King. Captive nut.</p>	<p>134477 Qty. 5 Repl. 2114-4862, 23470-M8001. I.D. 35 mm. O.D. 38.8 / 43.3 mm. Cap.</p>

803024 Brushes Replacing LUCAS

<p>140480 Qty. 2 Serv. M79. 12 V. 7 x 13.7 x 11.5 mm. Complete w/ bus bar Cargo 140897.</p>	<p>140481 Qty. 2 Serv. M79. 12 V. 7 x 13.7 x 11.5 mm. Complete w/ bus bar Cargo 140898.</p>	<p>140509 Qty. 2 Repl. 60600920. Serv. M80R. 12 V. 6.8 x 19.8 x 9 mm.</p>	<p>140511 Qty. 2 Repl. 60600946. Serv. M78R. 12 V. 6.8 x 13.8 x 9 mm.</p>
<p>140513 Qty. 2 Repl. 60600919. Serv. M80R. 12 V. 6.8 x 19.8 x 9 mm. Anti CW rotation.</p>	<p>LASX2 2 Qty. 2 Repl. 255659, TAB127. 12 V. 8.8 x 19.05 x 13.5 mm.</p>	<p>LASX2-3 4 Repl. 2 / 255659. 12 V. 8.8 x 19.05 x 13.5 mm. Qty. 2</p>	<p>LASX15-16 4 Repl. 271735, TAB125. 12 V. 7.9 x 19.05 x 22.2 mm. Qty. 2</p>
<p>LASX15-27 4 Repl. 271735(-1), TAB125. 12 V. 7.9 x 19.05 x 22.2 mm. Qty. 2</p>	<p>LASX31 4 Repl. 54258592, TAB119. 12 V. 7.9 x 19.05 x 22.2 mm. Qty. 2</p>	<p>LASX36 4 Repl. 54259517, TAB118. 12 V. 9 x 20 x 24.5 mm. Qty. 2</p>	<p>LASX37-38-39 Repl. 54242194. 12 V. 9.5 / 3.5 x 11.6 x 15.9 mm. Qty. 2</p>
<p>LASX40-41 2P Repl. 60600056, TAB117. 12 V. 9.5 / 3.5 x 11.6 x 15.9 mm. Qty. 2</p>	<p>LASX43-44 2 Repl. 54246258, TAB124. 12 V. 10.3 / 4.70 x 13.3 x 17.5 mm. Qty. 2</p>	<p>LASX44-45 2P Repl. TAB116. 12 V. 10.3 / 4.7 x 13.3 x 17.5 mm. Qty. 2</p>	<p>LASX73-41 2+1P Repl. 60600767, TAB103. 12 V. 9.5 / 3.5 x 11.6 x 15.9 mm. Qty. 2</p>

Bushings Replacing LUCAS

803025

 <p>140040 Qty. 10 Repl. M78, M79. 12.09 x 15.05 x 12 mm.</p>	 <p>140053 Qty. 10 Repl. 255491, TCB123. 15.97 x 19.12 x 19 mm.</p>	 <p>140056 Qty. 10 Repl. 54241267. 11.15 x 15.85 x 26.2 x 2.4 x 16.3 mm.</p>	 <p>140057 Qty. 10 Repl. 54252054, TCB114. 12.08 x 15.07 x 16.9 mm.</p>
 <p>140058 Qty. 10 Repl. 54252236. 14.06 x 17.06 x 19.7 mm.</p>	 <p>140144 Qty. 10 Repl. 271364, TCB120. 12.76 x 15.91 x 16.5 mm.</p>	<p>Save armatures !!</p>  <p>140158 Qty. 10 10.25 x 15.9 x 18 mm. Undersize for M35G. C.E.</p>	 <p>140212 Qty. 5 Repl. 54252494. Serv. M45G. 25.47 x 25.65 x 21.6 mm. I.M.</p>
 <p>140656 Qty. 10 Repl. 54257833. 12.75 x 19.14 x 14 mm.</p>	 <p>140657 Qty. 10 Repl. 54256132. 12.8 x 15.95 x 14 mm.</p>	 <p>140658 Qty. 10 Repl. 54255966. 17.07 x 21.05 x 22 mm.</p>	 <p>140659 Qty. 5 Repl. 54256151. 28.56 x 31.8 x 38.1 x 13 mm.</p>
 <p>140661 Qty. 10 19.10 x 22.25 x 25.40 x 2.6 x 20.6 mm.</p>	 <p>140663 Qty. 10 11.17 x 15.85 x 26.2 x 12.6 mm.</p>	 <p>140103 Qty. 5 Repl. 54245343, TCB116. 11.17 x 15.85 x 26.2 x 12.6 mm. 12.07 x 15.87 x 12.7 mm.</p>	 <p>140528 Qty. 5 Repl. 60600914, TCB129. 12.09 x 15.05 x 8 mm. 12.09 x 15.05 x 12 mm.</p>

Starter Parts Replacing LUCAS

803026

 <p>130744 Qty. 3 Repl. 291540, TLB182. Serv. M45G, 26143, 26153, 26154, 26172.</p>		 <p>132209 Qty. 10 Repl. 54259524. Serv. M45G, M50. Brush spring.</p>	 <p>134040 Qty. 2 Serv. 8M90, 9M90. 0.75 x 9.3 x 41 x 9.75 mm. Brush spring set.</p>	 <p>135119 Qty. 10 Serv. 2110... 7.9 x 9.9 x 31 mm. Th. 0.9 mm. Brush spring.</p>	 <p>140242 Qty. 5 Repl. HK1210. Serv. M78, M79. 12/16 x 10 mm.</p>	 <p>130879 Qty. 3 Repl. 54243952. Serv. M50. Brake kit.</p>	 <p>134095 Qty. 10 Serv. 2M100, 3M100. Paper strip.</p>
 <p>130744 Qty. 3 Repl. 291540, TLB182. Serv. M45G, 26143, 26153, 26154, 26172.</p>	 <p>132928 Qty. 5 Serv. 8M90, 25326. Shaft cap.</p>	 <p>133637 Qty. 5 Serv. 8M90, 9M90. Shaft end cap.</p>	 <p>134096 Qty. 5 Serv. 2M100, 3M100. Dust cover.</p>	 <p>133914 Qty. 10 Repl. TLB185. Serv. M35J, K, M78. Spire washer.</p>	 <p>133893 Qty. 5 Serv. M50. Part of kit 54243847. Pivot.</p>		
 <p>134446 Qty. 5 Serv. M127. Part of kit 60600861. Pivot pin.</p>	 <p>134459 Qty. 20 Serv. M35J. 1/4" UNF. Brass nut.</p>	 <p>134460 Qty. 20 Serv. M35J. 6 mm. Brass nut.</p>	 <p>130869 Qty. 10 Serv. M35J. Insulator for terminal post.</p>	 <p>132771 Qty. 10 Serv. M35G. Insulator.</p>	 <p>131298 Qty. 1 Repl. 54244971, 60600020. Serv. M50, M127. Sealing kit. Large.</p>		
 <p>134957 Qty. 10 Serv. M78, M79, M80. Clip.</p>	 <p>130871 Qty. 10 Repl. 272 022. Serv. M45G. Brass terminal 1/4" BSF.</p>	 <p>135122 Qty. 10 Serv. M35, M45, M50. Pole shoe screw. 3/8".</p>	 <p>135066 Qty. 10 Serv. M35J. Gasket for brush gear.</p>				

803027 Brushes Replacing MITSUBISHI





















 140345 Qty. 2 Repl. M648D10471, JMSTX-11. Serv. 31200-PC6-663, -PD2-663. 12 V. 6 x 14 16 mm.	 140346 Qty. 2 Repl. M648C22371. 12 V. 6.5 x 19 x 19 mm.	 140347 Qty. 2 Repl. M648C13770. 12 V. 6.8 x 12 x 17 mm.	 140348 Qty. 2 Repl. M648C25271. 12 V. 8 x 20 x 18 mm.
 140349 Qty. 2 Repl. M648C14870. 12 V. 6.8 x 10 x 17 mm.	 140386 Qty. 2 Repl. M648C24471, -24472. 12 V. 6.5 x 19 x 19 mm.	 140387 Qty. 2 Repl. M648C15372, -15472, -26371. 12 V. 6.8 x 18 x 18 mm.	 140388 Qty. 2 Repl. M648C25671, -25672. 12 V. 8 x 24 x 17 mm.
 140395 Qty. 2 Repl. M648C24973, -24974. 12 V. 8 x 25 x 20 mm.	 140556 Qty. 2 Repl. M648C12170. 12 V. 6.8 x 12 x 17 mm.	 140559 Qty. 2 Repl. M647C00271, -00272. Serv. PMGR, Mazda, Nissan. 12 V. 4.5 x 12 x 17.5 mm. LL. 65 mm.	 140560 Qty. 2 Repl. M647C00371, -00671. Serv. PMGR, AMC, Mazda. 12 V. 4.5 x 18 x 17.5 mm. LL. 75 mm.
 140568 Qty. 2 Repl. M647C00171. 12 V. 4.5 x 10 x 17.5 mm. LL. 44 mm. Set w/o bus bar Cargo 140931.	 140591 Qty. 2 Repl. MD607420. 12 V. 6.8 x 12 x 17 mm.	 140708 Qty. 2 Serv. M1T50172. 12 V. 6.8 x 14.5 x 16 mm.	 140709 Qty. 2 Serv. M1T50171. 12 V. 6.8 x 12 x 16 mm.

803003 Bushings Replacing MITSUBISHI

 140731 Qty. 10 Repl. M409X32571. 10 x 13 x 16 x 10.5 mm.	 140430 Qty. 10 Repl. MD611042. 10 x 14 x 9.5 mm.	 140319 Qty. 10 Repl. M409D30901. 10 X 14 X 12 mm.	 140555 Qty. 10 Repl. M409C12970. 10.02 x 14 x 12.5 mm.	 140466 Qty. 10 10.9 x 13 x 15.5 mm. No grease necessary.	 140428 Qty. 10 Repl. MD607741. 11.02 x 14 x 13 mm.	 140320 Qty. 10 Repl. MD602686. 11.06 x 13.03 x 13 mm.
 140429 Qty. 10 Repl. MD607903. 12.02 x 16 x 9.5 mm.	 140322 Qty. 10 Repl. MM502137. 12.23 x 14.32 x 15.7 mm.	 140694 Qty. 10 12.5 x 15.1 x 10 mm.	 140581 Qty. 10 12.8 x 14.4 x 18 mm.	 140586 Qty. 10 12.8 x 14.9 x 21.5 mm.	 140585 Qty. 10 12.8 x 14.9 x 26 mm.	
 140587 Qty. 10 12.8 x 15.7 x 21.5 mm.	 140629 Qty. 10 12.9 x 14.45 x 17.79 mm.	 140908 Qty. 10 14 x 16.04 x 10.8 mm. I.M.	 140323 Qty. 10 Repl. M410D12671. 14.2 x 16.2 x 15.7 mm.	 140321 Qty. 10 Repl. MD602213. 14.27 x 17.26 x 12.5 mm.	 140804 Qty. 10 15.03 x 20 x 10 mm. I.M.	
 140505 Qty. 10 Repl. M409D01301. 17 x 20 x 8 mm.	 140484 Qty. 10 18.8 x 20 x 11 mm. Together with bearing Cargo 140226 replacing bearing Cargo 140412. Gear reduction starters.	 140695 Qty. 10 18.8 x 20 x 11.5 mm.	 140779 Qty. 10 18.9 x 22 x 9 mm.	 140846 Qty. 10 19 x 22.05 x 9 mm.	 140324 Qty. 10 Repl. M409J00301. 20.6 x 24.6 x 10 mm.	

Starter Parts Replacing MITSUBISHI

803028

 <p>132638 Qty. 10 Serv. M5T22175, Yale. Brush spring.</p>	 <p>233867 Qty. 12 Serv. 36100-21740, -21770, -22000, MC109032. Brush spring.</p>	 <p>233868 Qty. 12 Serv. 36100-42010, -42011, MG120413. Brush spring.</p>	 <p>135201 Qty. 10 Repl. M391C02201. Serv. M3T56072, -56074, -56076, -56082. Brush spring.</p>	 <p>133020 Qty. 5 Repl. S806P10901, -94103. Serv. M2T65271. 18 / 35.1 x 7 mm. Oil seal.</p>		
 <p>133463 Qty. 2 Repl. M864X09571, -MD607921. Serv. M3T32588, -32591, -32592, -32593, -32782, -38882, -41081, -41083, -41088, -41285, -42781, M3T30881, -33081.</p>		 <p>134995 Qty. 5 Coupler (male).</p>	 <p>133036 Qty. 5 Repl. M578D20901. Serv. M2T65271. Yoke. Gasket.</p>	 <p>233541 Qty. 5 Servicing M1T60281, -71581, -71681, Cargo 133039, 133045, 133046, 133779, 134624, 137930, 137931, 138817. Coupler</p>		
 <p>134993 Qty. 5 1P - 1P Coupler (male - female).</p>	 <p>134995 Qty. 5 Coupler (male).</p>	 <p>135368 Qty. 3 Repl. M385X05071. Serv. MIT90081A. I.D. 12 mm. O.D. 17.5 mm. Th. 5 mm. Stop collar kit.</p>	 <p>132639 Qty. 3 Serv. M385X01273. I.D. 14.2 mm. O.D. 20.5 mm. Th. 6.8 mm. Stop collar kit.</p>			
 <p>133021 Qty. 3 Repl. M385X03771. I.D. 15 mm. O.D. 21 mm. Th. 6 mm. Stop collar kit.</p>	 <p>134851 Qty. 3 Repl. M385X04772. I.D. 12.1. O.D. 17.4 mm. Th. 4.3 mm.</p>	 <p>134949 Qty. 3 Repl. M385X00272. I.D. 13 mm. O.D. 17.5 mm. Th. 6.8 mm.</p>	 <p>134950 Qty. 3 Repl. M385X03471. I.D. 13.5. O.D. 19 mm. Th. 6 mm.</p>	 <p>134951 Qty. 3 Repl. M385X04671. I.D. 13 mm. O.D. 17.5 mm. Th. 4.7 mm.</p>	 <p>134952 Qty. 3 Repl. M385X04771. I.D. 12 mm. O.D. 17.4 mm. Th. 5 mm. Stop collar kit.</p>	 <p>134948 Qty. 5 Repl. M981D61301. I.D. 15.2 mm. O.D. 18.8 mm. Th. 1 mm.</p>

Brushes Replacing NIPPONDENSO











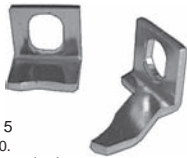







803029

 <p>140356 Qty. 2 Repl. 28142-21010. 12 V. 7 x 12 x 16 mm.</p>	 <p>140357 Qty. 2 Repl. 28531-0300. 12 V. 7 x 12 x 19 mm.</p>	 <p>140358 Qty. 2 Repl. 028530-0341. 12 V. 8 x 20 x 22 mm.</p>	 <p>140359 Qty. 2 Repl. 028531-0350. 12 V. 7 x 12 x 19 mm.</p>
 <p>140360 Qty. 2 Repl. 028531-0380. Serv. Ford. 12 V. 7 x 12 x 16 mm.</p>	 <p>140361 Qty. 2 Repl. 028531-0632. 12 V. 8 x 25 x 21 mm.</p>	 <p>140362 Qty. 2 Repl. 028531-0450. 12 V. 7 x 16 x 14 mm.</p>	 <p>140363 Qty. 2 Repl. 028531-0680. Serv. Ford. 12 V. 6.5 x 10 x 16 mm.</p>
 <p>140364 Qty. 2 Repl. 028099-3550, 028531-0840. 12 V. 8 x 25 x 15 mm.</p>	 <p>140393 Qty. 2 Repl. 028530-0480. Serv. John Deere tractor. 12 V. 9 x 30 x 26 mm.</p>	 <p>140396 Qty. 2 Repl. 028099-3430, -3950. 12 V. 7 x 16 x 13.5 mm.</p>	 <p>140566 Qty. 2 Repl. 028530-0932. Serv. 028000-8411. 12 V. 6 x 9 x 12 mm.</p>
 <p>140570 Qty. 2 Repl. 028530-5060. Serv. Honda B6, DB5. 12 V. 5 x 9 x 7.5 mm.</p>	 <p>140602 Qty. 2 Repl. 028099-5450. 12 V. 6.5 x 8 x 10 mm.</p>	 <p>140647 Qty. 2 Repl. 028099-3980. 12 V. 7.5 x 13 x 18 mm.</p>	 <p>140740 Qty. 2 Repl. 028099-6180. 12 V. 6.5 x 12.9 x 14.2 mm.</p>

803001 Bushings Replacing NIPPONDENSO

 140325 Qty. 10 Repl. 949103-0540,-1320,-2020. 12.54 x 16.55 x 14.0 mm.	 140326 Qty. 10 Repl. 028403-0081,28111-51011. 12.52 x 14.72 x 14.0 mm.	 140327 Qty. 10 Repl. 90099-10024, 949103-0380. 14.3 x 18.3 x 20.6 mm.	 140328 Qty. 10 Repl. 949103-0390. Serv. 028000-7110, -7112, -7120, -7121, Ford. 12.54 x 16.55 x 10.5 mm. C.E.		
 140329 Qty. 10 Repl. 028403-0060,28111-46010. 14.0 x 16.2 x 21.7 mm.	 140330 Qty. 10 Repl. 028403-0130,28111-46011. 14.2 x 16.3 x 19.8 mm.	 140331 Qty. 10 Repl. 28125-41020,949103-1660. 23.2 x 26.0 x 8.5 mm.	 140332 Qty. 8 Repl. 90099-10060,949103-1650. 24.0 x 28.3 x 18.0 mm.		
 140333 Qty. 10 Repl. 949103-3160. Serv. 28111-51011. 12.5 x 15.5 x 10.5 mm. CE	 140424 Qty. 10 Repl. 90099-10149,949103-3600. 10.1 x 15.5 x 10.4 mm.	 140425 Qty. 10 Repl. 90099-10150,949103-3610. 11.0 x 14.7 x 12.8 mm.	 140426 Qty. 10 Repl. 90099-10157. 11.02 x 14.72 x 8.0 mm.	 140427 Qty. 10 Repl. 90099-10158. 11.02 x 14.72 x 11.0 mm.	 140787 Qty. 10 6.1 x 10.05 x 7.4 mm. For planetary gear.
 140554 Qty. 10 22.71 x 28.5 x 5.9 mm. For clutch.	 140579 Qty. 10 12.6 x 15.55 x 12.8 mm. For drive.	 140582 Qty. 10 12.6 x 14.0 x 12.8 mm For drive.	 140583 Qty. 10 12.5 x 14.0 x 10.5 mm. For drive.	 140697 Qty. 10 23.9 x 29.17 x 6.03 mm. For clutch.	 140788 Qty. 10 Repl. 949104-0990. 7.09 x 9.51 x 13.0 x 11.2 mm.

803004 Solenoid Parts Replacing NIPPONDENSO

 131830 Qty. 5 Repl. 28017-19500. Serv. 1.4 kW. Gear reduction. Contact kit.	 133602 Qty. 2 Serv. 1, 1.2, 1.4, 2 kW. Contact kit.		 131832 Qty. 2 Repl. 28017-19512. Serv. 2.4 kW. Gear reduction. Contact kit.	 131833 Qty. 2 Repl. 28017-19511. Serv. 2.4 kW. Gear reduction. Contact kit.
 132563 Qty. 1 Repl. 053660-0401. Serv. 028000-7370. L. 95.5 mm, Contact O.D. 36.8 mm.	 132565 Qty. 2 Repl. 028099-3160. Serv. 028000-5510. 2.5 kW. Contact kit.	 132567 Qty. 2 Repl. 028099-2820. Serv. 028000-7370. 1, 1.2 kW. Contact kit.	 132568 Qty. 2 Repl. 028099-3390. Serv. 1.0, 1.2, 1.4 kW. Contact kit.	 132570 Qty. 1 Repl. 053660-0443, -0660. Serv. 028000-5510, -6290, -6870. 2.5 kW. L. 118.5 mm. Contact O.D. 39.8 mm. Plunger.
 131831 Qty. 2 Repl. 28017-19502. Serv. 1.4 kW. Gear reduction. Contact kit.	 133634 Qty. 2 Fixed w/ M10 stud, copper 3 mm. Contact kit.	 133635 Qty. 2 Fixed w/ M8 stud, copper 2.5 mm. Supplied w/ studs, nuts and insulators. Contact kit.	 135384 Qty. 2 Repl. 028099-7230. Contact kit.	 135385 Qty. 2 Repl. 028099-7210. Contact kit.
 139046 Qty. 2 Repl. 028099-7240. Serv. 128000-9310, -9880, -9890. 1.2, 1.4 kW. Contact kit.	 139047 Qty. 2 Repl. 028099-5240. Serv. 128000-0570, -0571, -1590. 1.2, 1.4 kW. Contact kit.	 139494 Qty. 2 Repl. 028099-7800. Serv. 228000-2120, -2690. 12 V. 2.0 kW. Contact kit.	 139532 Qty. 2 Repl. 028099-7750. Serv. 228000-0640, -0780. Contact kit.	

Starter Parts Replacing NIPPONDENSO I

803030







<p>132551 Qty. 10 Repl. 949173-0571. Serv. Toyota Hi Ace. W. 11.1 mm, Th. 0.5 mm.</p>	<p>132552 Qty. 10 Repl. 949173-0610. Serv. Toyota Camry. W. 11.1 mm, Th. 0.5 mm.</p>	<p>132887 Qty. 10 Repl. 949173-0461. Serv. 1.0 kW, 1.4 kW. W. 8 mm, Th. 0.55 mm.</p>	<p>133710 Qty. 10 Repl. 949170-9100. Serv. 128000-2750. 4.7 x 20.6 mm.</p>	<p>133810 Qty. 10 Repl. 028520-5010. Serv. 128000-2520. 6.2 x 22.4 mm.</p>	<p>131834 Qty. 5 Repl. 053480-7300. Serv. 128000-8311. terminal.</p>	<p>131835 Qty. 5 Repl. 053480-0090. Serv. Gear reduction. M4-0.7. S Terminal.</p>	<p>131836 Qty. 5 Serv. Gear reduction. M4-0.7. R terminal.</p>
<p>132705 Qty. 5 Repl. 053480-0110. Serv. 2.5 kW. Gr. reduc. Ignition switch terminal.</p>	<p>132709 Qty. 5 Serv. 128000-0280. Ignition switch terminal.</p>	<p>132870 Qty. 5 Serv. 128000-2570. M4-0.7 threaded post. Ignition switch terminal.</p>	<p>132897 Qty. 5 Serv. Early & late type. Gear reduction. Ignition switch terminal.</p>	<p>131837 Qty. 5 Repl. 949340-0660. Serv. Gear reduction starters. Blue. Terminal cap.</p>	<p>131838 Qty. 5 Repl. 949340-0531. Serv. Gear reduction starters. Grey. Terminal cap.</p>		
<p>132888 Qty. 10 Repl. 028062-0200. Serv. 1.4, 1.6, 2.5 kW. Gear reduction starters. Rubber drain.</p>	<p>132889 Qty. 2 Repl. 480841-0010. Serv. 2.5 kW. Gear reduction starters. Boot for terminal 50.</p>	<p>134788 Qty. 5 Serv. 1.0, 1.4, 2.0 kW. Gear reduction starters. Boot for terminal 50.</p>	<p>132885 Qty. 10 Repl. 028306-0070. Serv. 2.5, 4.0 kW. O.D. 7.5 x L. 13 mm.</p>	<p>132886 Qty. 10 Serv. 1.0, 1.4, 2.0 kW. 5.6 x 12.5 mm.</p>	<p>132894 Qty. 10 Repl. 949120-0240. Serv. 1.0, 1.4, 2.0 kW. O.D. 8.7 mm. Steel ball.</p>		
<p>132895 Qty. 5 Repl. 028063-0040. Serv. 1.0 - 2.2 kW. Plastic cage.</p>	<p>132896 Qty. 10 Repl. 028306-0061. Serv. 1.0 - 2.2 kW. O.D. 6 x L. 9.5 mm.</p>	<p>133716 Qty. 5 Repl. 028021-0291. Serv. 028000-8411, -9133. Stop collar kit.</p>	<p>132550 Qty. 5 Repl. 949170-4040. Serv. Toyota Hi Ace, Hi Lux Diesel. 2.5 kW. Gear reduction starters. O.D. 19.4 x L. 92 x wire Th. 1.3 mm. Clutch / drive spring.</p>				

Starter Parts Replacing NIPPONDENSO II

803031

<p>132068 Qty. 5 Serv. Gear reduction starters. Early type 1.0, 1.4 kW. Paper gasket.</p>	<p>132878 Qty. 5 Repl. 053404-0210, -0320. Serv. Gear reduction starters. Late type 1.0, 1.4 kW. Rubber gasket.</p>	<p>132879 Qty. 5 Repl. 053404-0240. Serv. 2.5, 3.0, 4.5, 5.0 kW. Gear reduction starters. Rubber gasket.</p>	<p>133708 Qty. 5 Repl. 028523-5050. Serv. 128000-2750, Honda. Insulator.</p>	<p>230721 Qty. 10 Repl. 949006-3840, -4930. M6 x 70 mm. Thru bolt.</p>	
<p>134867 Qty. 4 Gear reduction starters 1.0 kW. Field coil insulator. W/ external through bolts.</p>	<p>135166 Qty. 5 1.0, 1.4, 2.0 kW. I.D. 11.5 mm. Insulator, external terminal.</p>	<p>135167 Qty. 5 2.5 kW. I.D. 14 mm. Insulator, external term.</p>	<p>135168 Qty. 5 I.D. 10 mm. Insulator inside term.</p>	<p>191530 Qty. 6 Repl. 949006-3840. Thru bolt, slotted. Pozidrive, cheese head. Partly thread. 75/25 mm. Steel black. M6 x 75 mm.</p>	<p>191531 Qty. 20 Repl. M901X01571. Thru bolt, slotted. Pozidrive, cheese head. Partly thread. 85/25 mm. Steel black. M6 x 85 mm.</p>
<p>134992 Qty. 5 1P Coupler w/ lead wire w/ terminal. (female).</p>	<p>134994 Qty. 5 Coupler. (female).</p>	<p>135127 Qty. 10 Repl. 028017-0070. Serv. 028000-5330. Lock washer.</p>	<p>135128 Qty. 10 Repl. 028017-0110. Serv. 128000-0370. Lock washer.</p>		

803032 Brushes Replacing PARIS RHONE / VALEO

 PSX64-70 2 Qty. 2 Repl. 72591A. 12 V. 7 x 18 x 17 mm.	 PSX77-78 4 Qty. 2 Repl. 72632H. 12/24 V. 7 x 18 x 14 mm.	 PSX81-82 4 Qty. 2 Repl. 182114, -115. 12 V. 10 x 25 x 17 mm.	 PSX115-116 2 Qty. 2 Repl. 182064. 12 V. 7 x 18 x 14 mm.
 PSX119-120 2 Qty. 2 Repl. 182070. 12 V. 7 x 15 x 14 mm.	 PSX122-123-124 Qty. 2 Repl. 182073. 12 V. 9.7/4.2 x 12.4 x 15 mm.	 PSX129 2+1P Qty. 2 Repl. 182065. 12 V. 10.6/6.1 x 10.3 x 15 mm.	 PSX130 4 Qty. 2 Repl. 182068. 12 V. 10.6/6.1 x 10.3 x 15 mm.
 PSX132 4 Qty. 2 Repl. 182118. 12 V. 10 x 18 x 14 mm.	 PSX133 2 Qty. 2 Repl. 092914, 182067. 12 V. 13.9/6.9 x 12 x 15 mm.	 PSX133K 2 Qty. 2 Repl. 300706. Serv. D9E ... 12 V. 13.9/6.9 x 12 x 15 mm.	 PSX136-137 4 Qty. 2 Repl. 300841. 12 V. 7 x 15 x 18.5 mm.
 PSX138-139 2 Qty. 2 Repl. 182054. 12 V. 9 x 18 x 22 mm.	 PSX140-141 4 Qty. 2 Repl. 182051. 12 V. 9 x 18 x 22 mm.	 PSX144-145K Qty. 2 Repl. 594060, 594063. Serv. D6RA5, -6, -12, -16, -18, -20, -38, -61. 12 V. 4.5/9 x 11 x 18 mm.	 PSX146-147K Qty. 2 Repl. 594064, 594061. Serv. D6RA8, -10. 12 V. 4.7/9 x 11 x 14 mm.

803033 Bushings Replacing PARIS RHONE / VALEO

 140064 Qty. 10 Repl. 035070. 12.07 x 15.05 x 20 mm.	 140065 Qty. 10 Repl. 047852. 14.07 x 18.05 x 20 mm.	 140066 Qty. 10 Repl. 030826. 16 x 19.15 x 15 mm.	 140119 Qty. 10 Repl. 074952. 16 x 20.05 x 10 mm.			
 140043 Qty. 10 Repl. 068430. 12.07 x 15.05 x 15 mm.	 140258 Qty. 10 Repl. 105464. 10.03 x 13.04 x 13 mm.	 140259 Qty. 10 Repl. 105715. 10.03 x 13.04 x 16 mm.	 140440 Qty. 10 Repl. 104164. 16 x 20.08 x 8 mm.	 140496 Qty. 10 Serv. D6RA ... 12.03 x 15.04 x 10 mm. D.E.		
 140497 Qty. 10 Serv. D6RA ... 6.02 x 10.04 x 13.8 x 2.1 x 8.6 mm. C.E.	 140498 Qty. 10 Serv. D6RA ... 18.02 x 22.04 x 5 mm. I.M.	 140499 Qty. 10 Serv. D6RA ... 6.02 x 9.04 x 7 mm. I.M.	 140615 Qty. 10 Serv. D6RA ... 6.06 x 10.2 x 13.78 x 1.5 x 8.2 mm.	 140684 Qty. 10 Repl. 096485. 14.05 x 18.03 x 16 mm.	 140473 Qty. 11 Repl. 182158, NE 486. 4 bushes kit. 17.08 x 21.05 x 25 mm. 16.05 x 20.04 x 24.9 mm. 19 x 23 x 25 mm. 27.05 x 35.07 x 14 mm.	
 140474 Qty. 1 Repl. 182164, NE 623. 3 bushes kit. 20.05 x 28.05 x 29 mm. 20.05 x 28.07 x 32 x 25 x 3 mm. 27.07 x 35.06 x 40 x 29.5 x 3.5 mm.	 140526 Qty. 1 Repl. 182142. 12.07 x 15.05 x 15 mm. 16.00 x 19.15 x 15 mm. 20.04 x 24.05 x 16 mm.	 140531 Qty. 1 Repl. 182061. 12.07 x 15.05 x 15 mm.	 140533 Qty. 1 Repl. 182063, 583348. 12.09 x 15.05 x 12 mm. 12.09 x 15.05 x 12 mm.	 140537 Qty. 1 Repl. 182136. 14.07 x 18.05 x 20 mm. 16.00 x 19.15 x 15 mm. 20.00 x 24.06 x 17 mm. 20.10 x 24.07 x 18 mm.	 140540 Qty. 1 Repl. 182139. 14.07 x 18.00 x 16 mm. 14.07 x 18.05 x 30 mm. 16.00 x 19.15 x 15 mm. 20.04 x 24.05 x 16 mm.	 140541 Qty. 1 Repl. 182140. 12.07 x 15.05 x 15 mm. 14.05 x 18.03 x 16 mm. 16.00 x 19.15 x 15 mm. 20.02 x 24.06 x 12 mm.

Starter Parts Replacing PARIS RHONE / VALEO

803034

<p>132571 Qty. 1 Serv. D8E ... D9E ... Brush springs & spring caps kit.</p>	<p>134902 Qty. 10 Repl. 300842. Serv. D10E 85, -87. Brush spring.</p>	<p>135018 Qty. 10 Serv. D11E 43, -54, -56, -57, -58, -61, -62. Brush spring.</p>	<p>135326 Qty. 10 Serv. 594019, D6RA. 4 x 14 mm. Steel pin.</p>	<p>134142 Qty. 10 Serv. D11E ... Spacer for lever.</p>	<p>131618 Qty. 3 Repl. 075953. Brake cap, plastic. O.D. 28 mm. C.E.</p>	<p>131810 Qty. 3 Repl. 096473. Brake cap, plastic. O.D. 33 mm. C.E.</p>
<p>133667 Qty. 2 Serv. D11E ... Brake.</p>	<p>132381 Qty. 2 Serv. D10E. Cap.</p>	<p>134481 Qty. 5 Serv. 182178. 20 / 30 x 7 mm. Oil seal.</p>	<p>134106 Qty. 2 Serv. D6RA ... Rubber seal.</p>	<p>134107 Qty. 5 Serv. D6RA ... Rubber seal.</p>		
<p>134980 Qty. 5 Serv. D9E ... Rubber seal.</p>	<p>135317 Qty. 5 Serv. D9E ... Rubber seal.</p>	<p>135014 Qty. 5 Serv. D11E ... Rubber insulator.</p>	<p>134289 Qty. 5 Serv. D6RA. Insulator.</p>	<p>134699 Qty. 10 Serv. D9E. 12.3 x 24 x 1 mm. Fiber washer C.E.</p>	<p>134756 Qty. 10 41 x 52 mm. Gasket.</p>	
<p>134779 Qty. 10 Serv. D9E ... 9 x 9.35 x 2 mm. Plate.</p>	<p>134497 Qty. 1 Repl. 182126. Serv. D11E163, -164, -169, -170, -172, -173.</p>	<p>133078 Qty. 2 Repl. 594084. Serv. D6RA ...</p>	<p>134790 Qty. 2 Repl. 097804. Serv. D8E158, -153, -157. Stop collar kit. Lock ring Th. 1.5 mm.</p>	<p>134791 Qty. 2 Repl. 073294. Serv. D8E ... , D8L ... Stop collar kit. Lock ring Th. 2.05.</p>		

VARIOUS - Solenoid Parts for Bo/DR Eur./FE/MM

803035

<p>131591 Qty. 2 Serv. 0331 302 ... Plate 30 x 15 x 2 mm. Contact plate.</p>	<p>131592 Qty. 2 Serv. 0331 401 ... Plate 35 x 18 x 4 mm. Contact plate.</p>	<p>131594 Qty. 2 Serv. 0331 303 ... Plate 32 x 15 x 2 mm. Shaft 31.6 mm.</p>	<p>131595 Qty. 2 Serv. 0331 402 ... Plate 39.5 x 18 x 4 mm. Shaft 31.6 mm.</p>	<p>132275 Qty. 2 Serv. 0331 402 ... Plate 39.5 x 18 x 4 mm. Shaft 32.1 mm.</p>	<p>132276 Qty. 2 Serv. 0331 303 ... Plate 36 x 15 x 2 mm. Shaft 31.6 mm.</p>	<p>132277 Qty. 2 Serv. 0331 402 ... Plate 31 x 18 x 2.5 mm. Shaft 32.1 mm.</p>	<p>132281 Qty. 2 Serv. 0331 303 ... Plate 36 x 15 x 3 mm. Shaft 28 5 mm.</p>
<p>133503 Qty. 2 Serv. 0331 402 054. Plate 39.5 x 18 x 4 mm. Contact plate.</p>	<p>133568 Qty. 5 Serv. 0331 302 ... M8 x 20.5 mm. Fixed contact.</p>	<p>133569 Qty. 5 Serv. 0331 302 ... M8 x 30.5 mm. Fixed contact.</p>	<p>133570 Qty. 5 Serv. 0331 402 ... M10 x 33 mm. Fixed contact.</p>	<p>133571 Qty. 5 Serv. 0331 402 ... M10 x 41 mm. Fixed contact.</p>	<p>133572 Qty. 5 Serv. 0331 402 ... M8 x 36 mm. Fixed contact.</p>	<p>133573 Qty. 5 Serv. 0331 303 ... M8 x 26 mm. Fixed contact.</p>	
<p>133575 Qty. 5 Serv. 0331 303 ... M8 x 36 mm. Fixed contact.</p>	<p>134141 Qty. 5 Serv. 0331 303 ... M8 x 51 mm. Fixed contact.</p>	<p>132322 Qty. 2 Serv. DR 901, -902. Plate 32 x 15 x 2.5 mm. Shaft 36 mm.</p>	<p>133146 Qty. 2 Serv. DR 903, -904. Plate 32 x 16 x 2.5 mm. Shaft 32 mm.</p>	<p>133576 Qty. 5 Serv. DR 902. M8 x 20.5 mm. Fixed contact.</p>	<p>133577 Qty. 5 Serv. DR 901. M8 x 28.7 mm. Fixed contact.</p>	<p>133578 Qty. 5 Serv. DR 901. M8 x 33.5 mm. Fixed contact.</p>	
<p>133579 Qty. 5 Serv. 3471 561, -697. M8 x 29 mm. Fixed contact.</p>	<p>132724 Qty. 2 Serv. MOK 12-1. Plate 35.5 x 15 x 2.5 mm. Shaft 35.5 mm.</p>	<p>137348 Qty. 2 Plate 11.5 x 26.9 x 2 mm. Shaft 24.6 mm. Moving contact.</p>	<p>132139 Qty. 2 Serv. 632 213 00, -30. Plate 30 x 15/19 x 3 mm. Shaft 30.2 mm.</p>	<p>132246 Qty. 2 Serv. 855 300 10. Plate 32 x 15 x 2.5 mm. Shaft 30.2 mm.</p>	<p>132248 Qty. 2 Serv. 636 335 01. Plate 39.5 x 18 x 4 mm. Shaft 37 mm.</p>	<p>132251 Qty. 2 Serv. 636 016 00. Plate 32 x 15 x 2 mm. Shaft 29.6 mm.</p>	

803036 VARIOUS - Solenoid Parts for Du/Hi/Mi/PR

 132036 Qty. 2 Serv. 583330, 583331. Plate 37 x 14 x 3 mm. Shaft 42 mm. Moving contact.		 132147 Qty. 2 Serv. 583099, 583161, 682038. Plate 33.3 x 14 x 3 mm. Shaft 42 mm. Silver plated. Moving contact.		 134146 Qty. 5 M8 x 28.5 mm. Fixed contact.		 134147 Qty. 5 M8 x 24 mm. Fixed contact.		 134148 Qty. 5 M8 x 33 mm. Fixed contact.		 134149 Qty. 5 M8 x 33.25 mm. Fixed contact.					
 134150 Qty. 2 14 x 33 mm. Contact plate.		 133270 Qty. 2 Serv. Cargo 131144. Plate 24.2 x 2 mm. Shaft 29.5 mm.		 135103 Qty. 2 Serv. 2130-67005. Plate 34.3 x 3 mm. Shaft 33.2 mm.		 135104 Qty. 2 Serv. 2114-1700. Plate 14 x 31 x 2.4 mm. Shaft 30 mm.		 135105 Qty. 2 Serv. 2114-27501. Plate 24.2 x 2 mm. Shaft 40.5 mm.		 133891 Qty. 2 Serv. 16.905.423, -426. Plate 15.1 x 36.1 x 2 mm. Shaft 44.5 mm. Moving contact.		 133275 Qty. 2 Serv. Cargo 133039. Shaft 26 mm. Moving contact.			
 134673 Qty. 2 30 x 17.5 / 14 x 3 mm. 9.2 mm hole. Contact plate.		 135017 Qty. 2 14 x 30 x 3 mm. 9 mm hole. Contact plate.		 135106 Qty. 2 Serv. M370X50171. Shaft 39.5 mm. 14.2 x 31.3 x 2.3 mm.		 139955 Qty. 2 Serv. M371X62171. Shaft 28 mm. Moving contact.		 135108 Qty. 2 Serv. M372X00371. Shaft 37.7 mm. 14.5 x 31 x 3 mm.		 135137 Qty. 2 30 x 14 / 11 x 3 mm. Contact plate.		 132037 Qty. 2 Serv. CED 529, -538. Plate 33.3 x 14 x 2.5 mm. Shaft 27.8 mm.		 132124 Qty. 2 Serv. CED 517, -518. Plate 28.3 x 14 x 2.5 mm. Shaft 27.8 mm.	
 132145 Qty. 2 Serv. CED 417, -418, -421, -423. Plate 28.3 x 14 x 2.5 mm. Shaft 38.2 mm. Moving contact.		 132146 Qty. 2 Serv. CED 514, 519. Plate 33.3 x 15 x 3 mm. Shaft 33.5 mm. Moving contact.		 134152 Qty. 5 M8 x 47.5 mm. Fixed contact.		 134153 Qty. 5 M8 x 28.5 mm. Fixed contact.		 134154 Qty. 5 M8 x 37.5 mm. Fixed contact.		 135363 Qty. 2 15 x 33.3 x 3 mm. Moving contact.					

803038 VARIOUS - Brushes for Japanese Starters

 140334 Qty. 2 Repl. HITACHI 2114-8312. 12 V. 7 x 11 x 18 mm.		 140336 Qty. 2 Repl. HITACHI 2114-2315. 12 V. 7 x 11 x 16 mm.		 140338 Qty. 2 Repl. HITACHI 2114-1316. 12 V. 7 x 14 x 16 mm.		 140378 Qty. 2 Repl. HITACHI 2130-5312. 12 V. 8 x 25 x 18 mm.	
 140379 Qty. 2 Repl. HITACHI 2130-3315. 12 V. 7 x 19 x 15.5 mm.		 140567 Qty. 2 Repl. HITACHI 2130-23112. 12 V. 7 x 19 x 16 mm.		 140347 Qty. 2 Repl. MITSUBISHI M648C13770. 12 V. 6.8 x 12 x 17 mm.		 140349 Qty. 2 Repl. MITSUBISHI M648C14870. 12 V. 6.8 x 10 x 17 mm.	
 140387 Qty. 2 Repl. MITSUBISHI M648C15372. 12 V. 6.8 x 18 x 18 mm.		 140556 Qty. 2 Repl. MITSUBISHI M648C12170. 12 V. 6.8 x 12 x 17 mm.		 140559 Qty. 2 Repl. MITSUBISHI M647C00271 Serv. PMGR. 12 V. 4.5 x 12 x 17.5 mm.		 140708 Qty. 2 Serv. MITSUBISHI M1T50172. 12 V. 6.8 x 14.5 x 16 mm.	
 140361 Qty. 2 Repl. NIPPONDENSO 028531-0632. 12 V. 8 x 25 x 21 mm.		 140362 Qty. 2 Repl. NIPPONDENSO 028531-0450. 12 V. 7 x 16 x 14 mm.		 140363 Qty. 2 Repl. NIPPONDENSO 028531-0680. Serv. Ford. 12 V. 6.5 x 10 x 16 mm.		 140364 Qty. 2 Repl. NIPPONDENSO 028099-3550. 12 V. 8 x 25 x 15 mm.	

VARIOUS - Bushings & Bearings for Jap. starters

803042

 140314 Qty. 5 Repl. HITACHI. 2114-3606, 23319-21000. 11.04 x 15.08 x 15 mm.	 140310 Qty. 5 Repl. HITACHI. 2114-4661, 23319-N3300. 12.52 x 16 x 15 mm.	 140311 Qty. 5 Repl. HITACHI. 2114-5352, 23338-N3300. 12.5 x 16.05 x 12 mm.	 140313 Qty. 5 Repl. HITACHI. 2130-1310, 23338-61503. 14 x 18 x 17 mm.	 140317 Qty. 5 Repl. HITACHI. 2120-4401, 23441-37501. 20.35 x 26.5 x 12.5 mm.	 140489 Qty. 4 Repl. HITACHI. 2250-3601, 23319-29000. 16 x 11.1 x 17 mm.	 140319 Qty. 5 Repl. MITSUBISHI. M409D30901. 10 x 14 x 12 mm.	 140320 Qty. 5 Repl. MITSUBISHI. MD602686. 11.06 x 13.03 x 13 mm.
 140321 Qty. 5 Repl. MITSUBISHI. MD602213. 14.27 x 17.26 x 12.5 mm.	 140428 Qty. 5 Repl. MITSUBISHI. MD607741. 11.02 x 14 x 13 mm.	 140429 Qty. 5 Repl. MITSUBISHI. MD607903. 12.02 x 16 X x.5 mm.	 140430 Qty. 5 Repl. MITSUBISHI. MD611042. 10 x 14 x 12 mm.	 140466 Qty. 5 Repl. MITSUBISHI. 10.9 x 13 x 15.5 mm. No grease necessary.	 140505 Qty. 5 Repl. MITSUBISHI. M409D01301. 17 x 20 x 8 mm.	 140555 Qty. 5 Repl. MITSUBISHI. M409C12970. 10.02 x 14 x 12.5 mm.	 140731 Qty. 5 Repl. MITSUBISHI. M409X32571. 10 x 13 x 16 x 10.5 mm.
 140325 Qty. 5 Repl. NIPPONDENSO. 949103-0540, 1320. 12.54 x 16.55 x 14 mm.	 140326 Qty. 5 Repl. NIPPONDENSO. 028403-0081. 12.52 x 14.72 x 14 mm.	 140328 Qty. 5 Repl. NIPPONDENSO. 949103-0390. 12.54 x 16.55 x 10.5 mm.	 140333 Qty. 5 Repl. NIPPONDENSO. 949103-10134. 12.5 x 15.5 x 10.5 mm.	 140425 Qty. 5 Repl. NIPPONDENSO. 90099-101150. 11 x 14.7 x 12.8 mm.	 140426 Qty. 5 Repl. NIPPONDENSO. 90099-10157. 11.02 x 14.72 x 8 mm.	 140427 Qty. 5 Repl. NIPPONDENSO. 90099-10158. 11.02 X 14.72 X 11 mm.	 140273 Qty. 2 6003 2RS1/C3. 17 x 35 x 10 mm.
 140222 Qty. 2 Repl. 949100-1360, -2500, -4120. 8/22 x 7 mm.	 140272 Qty. 2 6002 2RS1/C3. 15 x 32 x 9 mm.	 140223 Qty. 2 6004 2RS1/C3. 20 x 42 x 12 mm.	 B140271P Qty. 2 6000 2RS1/C3. 10 x 26 x 8 mm.	 140225 Qty. 2 6903 2RS. 17 x 30 x 7 mm.	 140226 Qty. 2 6904 2RS. 20 x 37 x 9 mm.	 140412 Qty. 2 Serv. M3T19991. Gear reduction starters. 19 x 37 x 9 mm. D.E.	 140301 Qty. 2 6292Z/C3. 9 x 26 x 8 mm.

VARIOUS - Brushes for DC-Motors

803005

 140164 Qty. 10 Serv. Bosch, Webasto. 8 x 10 x 19 mm.	 140408 Qty. 4 Serv. MB 1TWA, Cargo 110342. 12 / 24 V. 2 kW. 9 x 13 x 25 mm.	 140410 Qty. 4 Serv. MC 4TWA, Cargo 110345. 12 / 24 V. 3 kW. 9 x 20 x 28 mm.	 H5-6 Qty. 10 Serv. Lucas, Smith. 6.3 x 6.3 x 11.9 mm.
 H26 Qty. 10 Serv. Webasto. 9 x 6 x 16.5 mm.	 H54 Qty. 10 Repl. EP533BOS. Serv. Boi-Wo, Heat-on. 5 x 6.4 x 10 mm.	 H56 Qty. 10 Serv. Elektrolux. 5 x 6 x 12.7 mm.	 H106 Qty. 6 Repl. 00-14-16-31. Serv. AVOG. 12 x 8 x 21 mm.
 PL5 Qty. 6 7.9 x 7.9 x 21 mm.	 SW126 Qty. 10 Repl. SWF 495 299. 6.4 x 6.4 x 11.2 mm.		

803041 VARIOUS - Brush Springs

 136946 Qty. 4 Repl. 36162-21710. Serv. PMGR. Brush spring.	 136947 Qty. 4 Repl. 36164-21720. Serv. PMGR. Brush spring.	 233867 Qty. 6 Serv. 36100-21740, -21770, -22000, MC109032. Brush spring.	 134902 Qty. 4 Repl. 300842. Serv. D10E 85, -87. Brush spring.	 135018 Qty. 4 Serv. D11E 43, -54. Brush spring.	 132887 Qty. 4 Repl. 949173-0461. Serv. 1.0 kW, 1.4 kW. W. 8 mm, Th. 0.55 mm.	 133731 Qty. 4 Repl. 2130-6313. Serv. S13-62B, -64. Brush spring.	 138639 Qty. 4 Serv. MT67AC, MT68AC. Brush spring.
 132224 Qty. 4 Repl. 2004 652 038. Serv. 0001 359 ... Brush spring.	 134442 Qty. 4 Repl. 2004 652 034. Serv. BNG 0001 401 049. Brush spring.	 135460 Qty. 4 Repl. 2004 652 010. Serv. 0001 357 002. Brush spring.	 131499 Qty. 4 Repl. 2004 652 006. Serv. FKB, 0001 410 ... Brush spring.	 135770 Qty. 4 Repl. 723 631 10. Serv. MT67AC. Brush spring.	 137700 Qty. 4 Repl. 949173-0600. Serv. All 0.8, 0.9 kW. Brush spring.	 132552 Qty. 4 Repl. 949173-0610. W. 11.1 mm, Th. 0.5 mm. Brush spring.	 233868 Qty. 4 Serv. 36100-42010, -42011, MG120413. Brush spring.
 135201 Qty. 4 Repl. M391C02201. Serv. M3T56072. Brush spring.	 132551 Qty. 4 Repl. 949173-0571. W. 11.1 mm, Th. 0.5 mm. Brush spring.	 132209 Qty. 4 Repl. 54259524. Serv. M45G, M50. Brush spring.	 136694 Qty. 4 Repl. 2004 652 004. Serv. 0001 420 ... Brush spring.	 133810 Qty. 4 Repl. 028520-5010. Serv. 128000-2520. 6.2 x 22.4 mm.	 135299 Qty. 4 Serv. 0001 112 ... Brush spring.	 132576 Qty. 4 Serv. 0001 108 ... Gear reduction starters. Brush spring.	 134548 Qty. 4 Repl. 1004 611 006. Serv. 0001 312 ... Brush spring.
 134937 Qty. 4 Repl. 1004 611 007. Serv. 0001 208 ... Brush spring.	 133557 Qty. 4 Serv. 0001 110 ... Gear reduction starters. Brush spring.	 133197 Qty. 4 Serv. All European starters. Brush spring.	 135422 Qty. 4 Serv. D7R ... 9 x 27 mm. Brush spring.	 132223 Qty. 4 Repl. 2004 616 007. Serv. 0001 367 ... Brush spring.	 133556 Qty. 4 Repl. 2004 618 004. Serv. 0001 362 ... Brush spring.	 135004 Qty. 4 Repl. 1004 615 001. Serv. 0001 218 ... Brush spring.	 132571 Qty. 2 Serv. D8E ... Brush springs & spring caps kit.

803040 VARIOUS - Grommets

 134958 Qty. 5 Serv. 0001 208 ... Insulator.	 134959 Qty. 5 Serv. 0001 317 ... Insulator.	 135050 Qty. 5 Serv. 0001 208 ... Grommet.	 135051 Qty. 5 Serv. 0001 108 ... Grommet.	 135052 Qty. 5 Serv. 0001 108 ... Grommet.	 135053 Qty. 5 Serv. 0001 108 ... Grommet.	 137165 Qty. 5 Serv. 534 ... Grommet, for field coil.
 135055 Qty. 5 Serv. 0001 317 ... Grommet.	 135062 Qty. 5 Serv. 0001 108 ... Grommet.	 135259 Qty. 5 Serv. 0001 208 ... 10 x 10.5 x 25.5 mm. Grommet.	 135879 Qty. 5 Serv. D9E ... Grommet.	 135968 Qty. 5 Serv. D9R ... Grommet.	 135969 Qty. 5 Serv. E95. Grommet.	 134328 Qty. 3 1.0 kW. Offset gear reduction. Blue. L. 79 mm. Grommet, field coil terminal.
 134329 Qty. 3 1.4, 1.6 kW. Offset gear reduction. L. 67 mm. Grommet, field coil terminal.	 137590 Qty. 3 Serv. 2.5, 4.5 kW. L. 97.5 mm. Grommet, field coil terminal.	 137591 Qty. 3 Serv. 1.2 kW. Off-set gear reduction. L. 79 mm. Grommet, field coil terminal.	 137594 Qty. 3 Serv. 1.4, 2.0 kW. Off-set gear reduction. L. 84 mm. Grommet, field coil terminal.			

VARIOUS - Oil Seals **803039**

 131448 Qty. 2 Repl. 2000 283 013. Serv. FKB. 33/45 x 7 mm.	 131449 Qty. 2 Repl. 2000 212 000. Serv. FKB.	 131450 Qty. 10 Repl. 2004 650 030. Serv. FKB. Spring for oil seal.	 132682 Qty. 3 Repl. 1867150. Serv. 30 MT. 17.46/34.8 x 6.35 mm.	 132825 Qty. 3 Repl. 1937310. Serv. 10 MT. 17.86/31.75 x 6.35 mm.	 133020 Qty. 3 Repl. S806P10901. Serv. M2T64471. 18/35 x 7 mm.	 134481 Qty. 5 Serv. 182178. 20/30 x 7 mm.	 233545 Qty. 5 Repl. 1000 500 091. Serv. 0001 121 016. 28/38.2 x 2.7 mm.
 132296 Qty. 5 Repl. 2000 121 003. Serv. BNG. D.E.	 132382 Qty. 3 Repl. 1918047. Serv. 40 MT, 42 MT. 19.45/34.81 X 9.55 mm.	 135199 Qty. 5 Serv. 28 MT, 1113272, 1113285. 23.4 x 35.2 x 6 mm.		 135372 Qty. 5 Repl. 2000 283 012, -015. Serv. 0001 510 . . . 35/47 x 7 mm.		 135575 Qty. 5 Repl. 2916 740 049. Serv. 0001 367 036, -038, -046, -051. 19/27 x 6 mm.	
 135579 Qty. 5 Repl. 2000 283 016. 19/32 x 7 mm.		 135642 Qty. 5 Repl. 1937718. Serv. 37 MT. 13/16" x 1 3/8" x 1/4".		 135851 Qty. 5 Repl. 949150-1050. Serv. 028000-3290, -3291, -3292, -3650. 30/42.1 x 8 mm.		 135940 Qty. 5 Repl. S806P94203. Serv. M2T56471, -61371, -65271. 18.73/42 x 7 mm.	
 136665 Qty. 5 Serv. 0001 420 . . . 22/35 x 7 mm.		 136791 Qty. 5 Repl. 1000 221 001. Serv. 0001 212 206, -400, -401.		 137177 Qty. 5 Repl. 1000 221 000. Serv. 0001 212 211, -212, 0001 312 108, -109.		 138121 Qty. 5 Repl. 2130-1402. Serv. S13-33A, -33B, -34A, -37. 79/90 x 8 mm.	

VARIOUS - O-Rings for Alternators & Starters **803007**

 134485 Qty. 10 4 x 2 mm.	 134484 Qty. 10 5 x 2 mm.	 134633 Qty. 10 6 x 2 mm.	 134692 Qty. 10 6 x 2.5 mm.	 134486 Qty. 10 8 x 2 mm.	 134487 Qty. 10 10 x 2 mm.	 134776 Qty. 10 12 x 3 mm.	 134482 Qty. 10 16 x 2.5 mm.
 132660 Qty. 10 25 x 2 mm.	 134612 Qty. 10 35 x 2 mm.	 134491 Qty. 10 40 x 1 mm.	 134488 Qty. 10 40 x 2 mm.	 134489 Qty. 10 43 x 2 mm.	 132893 Qty. 10 43 x 2.5 mm.	 134716 Qty. 10 47.29 x 2.62 mm.	 132891 Qty. 10 48 x 2.5 mm.
 134931 Qty. 5 52 x 3 mm.	 133040 Qty. 5 56 x 2 mm.	 132659 Qty. 5 61 x 2 mm.	 134490 Qty. 5 62 x 2 mm.	 133717 Qty. 5 63.5 x 1.58 mm.	 133597 Qty. 5 64 x 2.5 mm.	 132892 Qty. 5 69 x 2 mm.	 132900 Qty. 5 71 x 2 mm.
 133598 Qty. 5 72 x 2 mm.		 133965 Qty. 5 87 x 1.5 mm.		 134965 Qty. 5 100 x 2 mm.		 134613 Qty. 5 104.5 x 3 mm.	

803013 VARIOUS - Special Bearings

 <p>140468 Qty. 5 Serv. PMGR series. 8/12 x 10 mm. Gear Shaft.</p>	 <p>140242 Qty. 5 Serv. PMGR series. 12/16 x 10 mm. Gear reduction starter.</p>	 <p>140470 Qty. 5 Serv. PMGR series. 25.4/31.75 x 9.53 mm.. Stationary gear.</p>	 <p>140222 Qty. 5 Repl. 949100-1360, 2500, 4 Serv. Gear reduction starters. 8/22 x 7 mm.</p>
 <p>140223 Qty. 5 Repl. 949100-1650, -1760. Serv. Gear reduction starters. 20/42 x 12 mm.</p>	 <p>140225 Qty. 5 Repl. 2114-25502, 23338-M4900 Serv. Gear reduction starters. 17/30 x 7 mm.</p>	 <p>140226 Qty. 5 Repl. 2114-35502, 23358-M4900. Serv. Gear reduction starters. 20/37 x 9 mm.</p>	 <p>140227 Qty. 5 Repl. 2130-3302, 23441-J550 Serv. Gear reduction starters. 25/42 x 9 mm.</p>
 <p>140381 Qty. 5 Repl. HK 2212. 22/28.1 x 12 mm.</p>	 <p>140457 Qty. 5 Repl. HK 2012. 20/26 x 12 mm.</p>	 <p>140494 Qty. 5 Repl. HK 1212. 12/18 x 12 mm.</p>	 <p>140224 Qty. 5 Repl. 6902 2RS1. Serv. Honda. Gear reduction starters. 15/28 x 7 mm.</p>
 <p>140412 Qty. 5 Serv. M3T19971. Gear reduction starters. 19/37 x 9 mm. D.E. W/ bushing.</p>	 <p>140514 Qty. 5 Repl. S933P65270. 12/17 x 12 mm.</p>	 <p>140630 Qty. 2 Repl. 949100-3270. 15/36 x 18 mm.</p>	 <p>140375 Qty. 5 Serv. D9R. 18/24 x 12 mm.</p>

803006 VARIOUS - Terminal Leads

 <p>133370 Qty. 5 6 mm² terminal lead, LL. 95 mm. Hole 8 mm.</p>	 <p>133371 Qty. 5 8 mm² terminal lead, LL. 95 mm. Hole 8 mm.</p>	 <p>133372 Qty. 5 10 mm² terminal lead, LL. 95 mm. Hole 8 mm.</p>	 <p>133390 Qty. 5 8 mm² terminal lead, LL. 60 mm. Hole 8 mm.</p>	 <p>133505 Qty. 5 6 mm² terminal lead, LL. 30 mm. Hole 8 mm.</p>	 <p>133506 Qty. 5 6 mm² terminal lead, LL. 40 mm. Hole 8 mm.</p>	 <p>134064 Qty. 5 8 mm² terminal lead, LL. 53 mm. Hole 8 mm.</p>	 <p>134921 Qty. 5 8 mm² terminal lead, LL. 60 mm. Hole 10 mm.</p>
 <p>140398 Qty. 1 Brush lead 2.5 mm². Length 1 m.</p>	 <p>140399 Qty. 1 Brush lead 6 mm². Length 1 m.</p>	 <p>140400 Qty. 1 Brush lead 10 mm². Length 1 m.</p>	 <p>140704 Qty. 1 Brush lead 16 mm². Length 1 m.</p>				

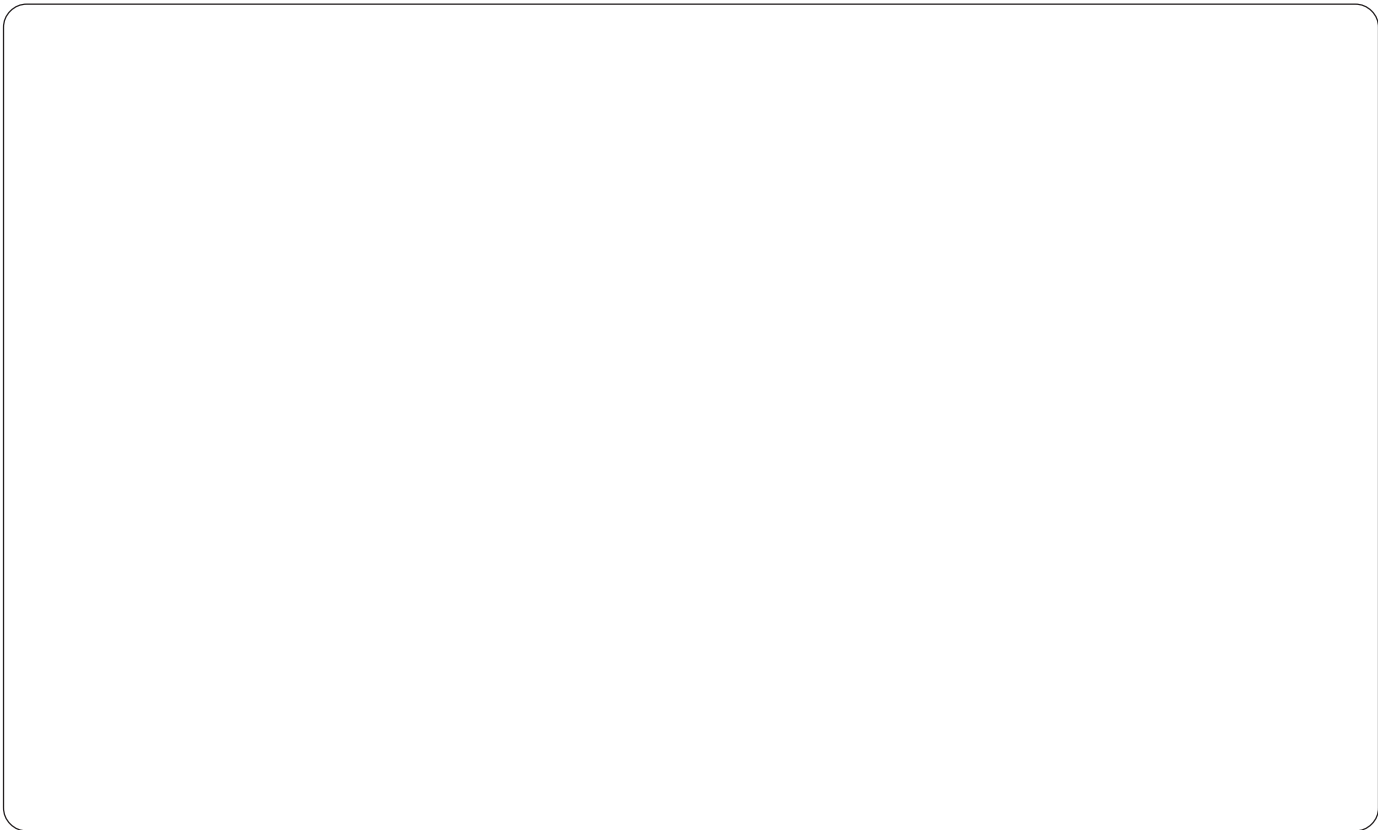
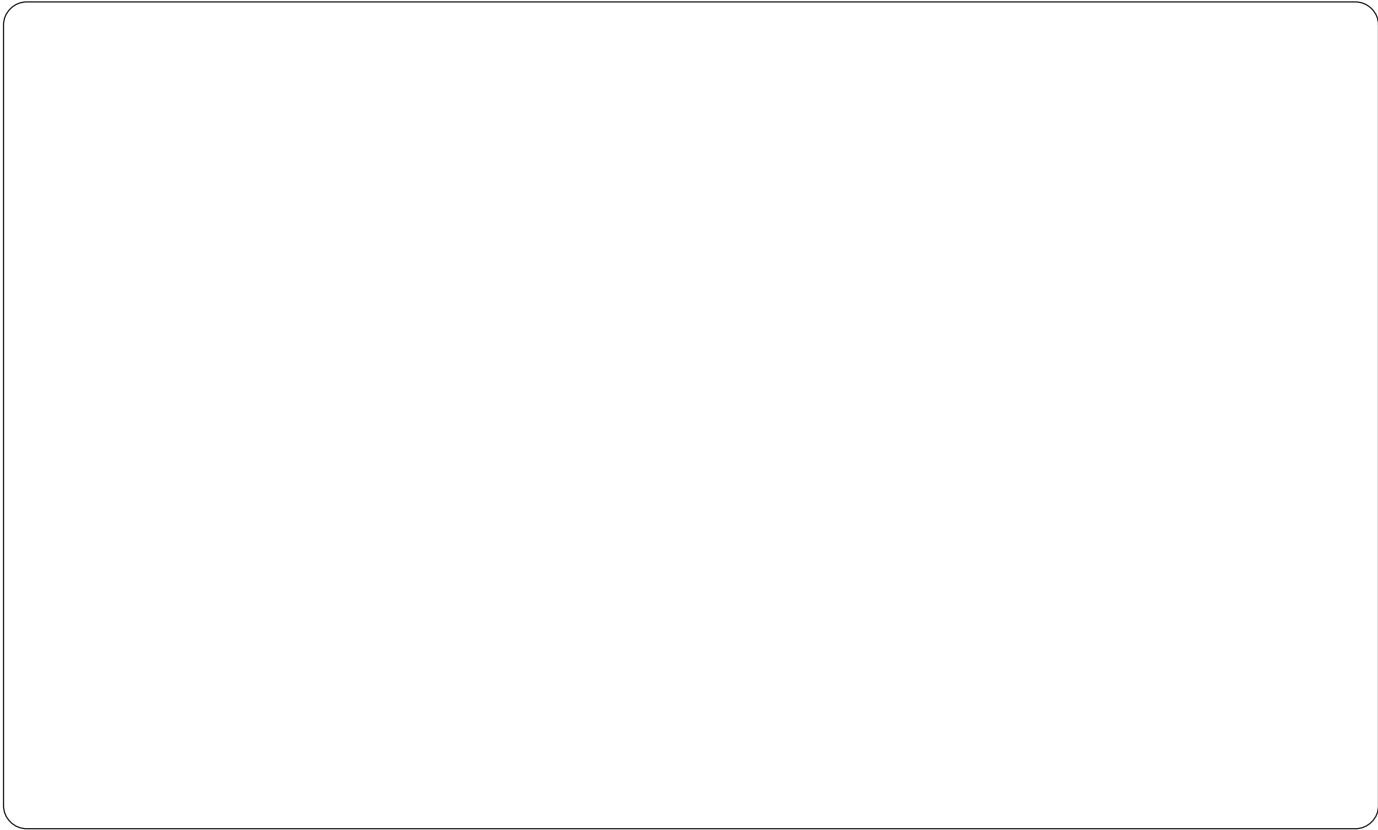



ASSORTMENTS

PART 4

Notes

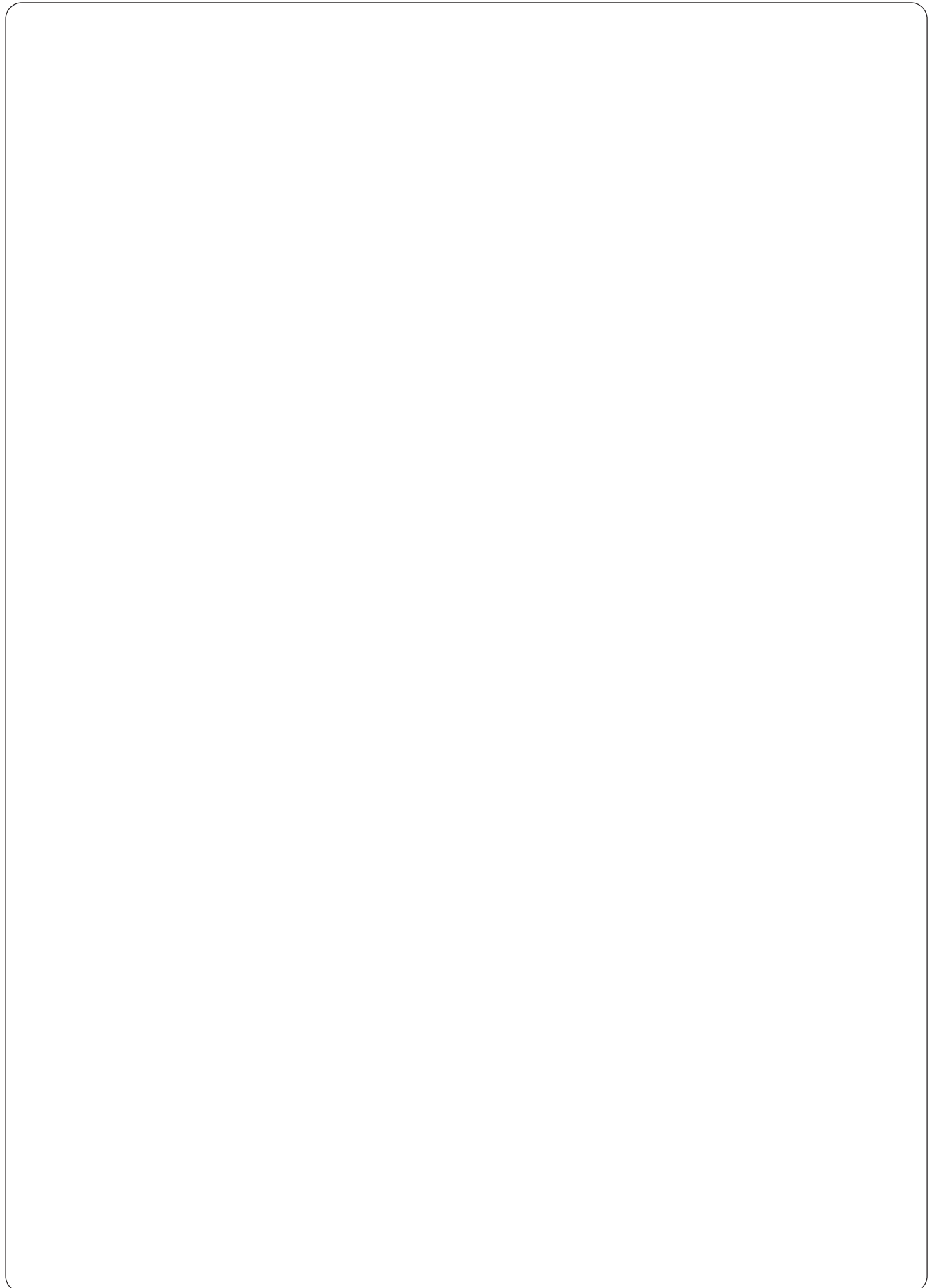
A large, empty rectangular box with rounded corners, intended for writing notes. The box is white and occupies most of the page area below the "Notes" header.

804017 ABS Connectors & tools

<p>210643 Qty. 1 Ejection tool. For round terminals w/ locking tongues. For mounting and dismantling bushes 6.5 mm. (Special for ABS and other weatherproof connections.) (Supplied w/o Cargo 210644, 210645.)</p>	<p>180245 Qty. 2 Sealing disc kit for ABS - socket.</p>	<p>192180 Qty. 10 Female type. 1.5 mm² cable. To be used w/ Cargo 180242, 180252, 180285 and 180570.</p>	<p>192181 Qty. 10 Tube for 4.0 mm² cable. To be used w/ Cargo 180242, 180252, 180285 and 180570.</p>	<p>191168 Qty. 10 Tube for 1.5-2.5 mm² cable. To be used w/ Cargo 180242 or 180252.</p>	<p>191169 Qty. 10 Tube for 4.0-6.0 mm² cable. To be used w/ Cargo 180242 or 180252.</p>		
		<p>191196 Qty. 10 Male type. 1.5 mm². To be used w/ Cargo 180243, 180253, 180286 and 180571.</p>	<p>191197 Qty. 10 Male type. 4.0 mm². To be used w/ Cargo 180243, 180253, 180286 and 180571.</p>	<p>191171 Qty. 10 Male type 1.5-2.5 mm². To be used w/ Cargo 180243 or 180253.</p>	<p>191172 Qty. 10 Male type 4.0-6.0 mm². To be used w/ Cargo 180243 or 180253.</p>		
	<p>210644 Qty. 1 Dismounting bush. 6.5 mm². To be used w/ Cargo 210643.</p>	<p>210639 Qty. 1 Crimping tool. For non-insulated terminals. Professional for terminals 0.75-6.0 mm².</p>					
	<p>210645 Qty. 1 Dismounting bush. 6.5 mm². To be used w/ Cargo 210643.</p>						

















804048 Red Crimp Terminals - Insulated

<p>190049 Qty. 100 2.8 mm. Flat plug.</p>	<p>190045 Qty. 100 4.7 mm. Flat plug.</p>	<p>190022 Qty. 100 6.3 mm. Flat plug.</p>	<p>190025 Qty. 50 6.3 mm. Flat plug and piggyback.</p>	<p>190985 Qty. 100 6.3 mm. Flat plug, fully insulated.</p>
<p>190019 Qty. 100 6.3 mm. Flat tongue.</p>	<p>190021 Qty. 100 O.D. 4 mm. Round plug.</p>	<p>190017 Qty. 100 I.D. 4 mm. Round plug receptacle.</p>	<p>190028 Qty. 100 Butt connector.</p>	
<p>191009 Qty. 25 Butt connector. Shrinkable w/ glue.</p>	<p>190038 Qty. 100 3 mm. Ring.</p>	<p>190027 Qty. 100 4 mm. Ring.</p>	<p>190031 Qty. 100 5 mm. Ring.</p>	
<p>190015 Qty. 100 6 mm. Ring.</p>	<p>191501 Qty. 100 2 mm. Spade.</p>	<p>190973 Qty. 100 4 mm. Spade.</p>	<p>190974 Qty. 100 Pin.</p>	

O.E.M. names and numbers are used for reference purposes only.

Blue Crimp Terminals - Insulated

804049

 190020 Qty. 100 6.3 mm. Flat plug.		 190041 Qty. 50 8.0 mm. Flat plug.		 190026 Qty. 50 6.3 mm. Flat plug and piggyback.		 190046 Qty. 100 6.3 mm. Flat plug, fully insulated.		
 190016 Qty. 100 6.3 mm. Flat tongue.		 190023 Qty. 100 O.D. 5 mm. Round plug.		 190018 Qty. 50 I.D. 5 mm. Round plug receptacle.		 190001 Qty. 100 Butt connector.		
 191010 Qty. 25 Butt connector. Shrinkable w/ glue.	 190257 Qty. 100 3 mm. Ring.	 190029 Qty. 100 4 mm. Ring.	 190032 Qty. 100 5 mm. Ring.	 190034 Qty. 100 6 mm. Ring.				
 190039 Qty. 100 8 mm. Ring.		 191067 Qty. 100 4 mm. Spade.		 190037 Qty. 100 5 mm. Spade.		 190952 Qty. 100 Pin.		

Yellow Crimp Terminals - Insulated

804050

 190024 Qty. 100 6.3 mm. Flat plug.		 190048 Qty. 50 9.5 mm. Flat plug.		 191191 Qty. 50 6.3 mm. Flat Tongue.		 190051 Qty. 50 O.D. 5 mm. Round plug.		
 190050 Qty. 50 I.D. 5 mm. Round plug receptacle.		 190030 Qty. 50 Butt connector.		 191011 Qty. 25 Butt connector. Shrinkable w/ glue.		 190033 Qty. 50 5 mm. Ring.		
 190035 Qty. 50 6 mm. Ring.		 190255 Qty. 50 8 mm. Ring.	 190042 Qty. 50 10 mm. Ring.		 191515 Qty. 100 12 mm. Ring.		 190953 Qty. 100 Pin.	

804014 Crimp Terminals - Insulated I

<p>190028 Qty. 100 Red. Butt connector. 0.25 - 1.6 mm².</p>	<p>190001 Qty. 100 Blue. Butt connector. 1.0 - 2.6 mm².</p>	<p>191009 Qty. 25 Red. Butt connector. Shrinkable w/ glue. 0.25 - 1.6 mm².</p>	<p>191010 Qty. 25 Blue. Butt connector. Shrinkable w/ glue. 1.0 - 2.6 mm².</p>	<p>191011 Qty. 20 Yellow. Butt connector. Shrinkable w/ glue. 2.6 - 6.6 mm².</p>	<p>190049 Qty. 100 Red. 2.8 mm. flat plug. 0.25 - 1.6 mm².</p>
<p>190045 Qty. 100 Red. 4.7 mm. Flat plug. 0.25 - 1.6 mm².</p>	<p>190016 Qty. 100 Blue. 6.3 mm. Flat tongue. 1.0 - 2.6 mm².</p>	<p>190022 Qty. 100 Red. 6.3 mm. Flat tongue. 0.25 - 1.6 mm².</p>	<p>190019 Qty. 100 Red. 6.3 mm. Flat tongue. 0.25 - 1.6 mm².</p>	<p>190020 Qty. 100 Blue. 6.3 mm. Flat tongue. 1.0 - 2.6 mm².</p>	<p>190025 Qty. 50 Red. 6.3 mm. Flat plug and piggyback. 0.25 - 1.6 mm².</p>
<p>190026 Qty. 50 Blue. 6.3 mm. Flat plug and piggyback. 1.0 - 2.6 mm².</p>	<p>190041 Qty. 50 Blue. 8.0 mm. Flat tongue. 1.0 - 2.6 mm².</p>	<p>190024 Qty. 40 Yellow. 6.3 mm. Flat plug. 2.6 - 6.6 mm².</p>	<p>190048 Qty. 50 Yellow. 9.5 mm. Flat plug. 2.6 - 6.6 mm².</p>	<p>190985 Qty. 100 Red. 6.3 mm. Flat plug, fully insulated. 0.25 - 1.6 mm².</p>	
<p>190046 Qty. 100 Blue. 6.3 mm. Flat plug, fully insulated. 1.0 - 2.6 mm².</p>	<p>190021 Qty. 100 Red. Round plug. O.D. 4 mm. 0.25 - 1.6 mm².</p>	<p>190017 Qty. 100 Red. Round plug receptacle. I.D. 4 mm. 0.25 - 1.6 mm².</p>	<p>190023 Qty. 75 Blue. Round plug. O.D. 5 mm. 1.0 - 1.6 mm².</p>	<p>190018 Qty. 50 Blue. Round plug receptacle. I.D. 5 mm. 1.0 - 2.6 mm².</p>	

804095 Insulated Crimp Terminals II

<p>190022 Qty. 100 Red. 0.25 - 1.6 mm². 6.3 mm. Flat plug.</p>	<p>190019 Qty. 100 Red. 0.25 - 1.6 mm². 6.3 mm. Flat tongue.</p>	<p>190985 Qty. 100 Red. 0.25 - 1.6 mm². 6.3 mm. Flat plug, fully insulated.</p>	<p>190021 Qty. 100 Red. 0.25 - 1.6 mm². O.D. 4.0 mm. Round plug.</p>
<p>190017 Qty. 100 Red. 0.25 - 1.6 mm². I.D. 4.0 mm. Round plug receptacle.</p>	<p>190028 Qty. 100 Red. 0.25 - 1.6 mm². Butt connector.</p>	<p>190020 Qty. 100 Blue. 1.0 - 2.6 mm². 6.3 mm. Flat plug.</p>	<p>190016 Qty. 100 Blue. 1.0 - 2.6 mm². 6.3 mm. Flat tongue.</p>
<p>190026 Qty. 100 Blue. 1.0 - 2.6 mm². 6.3 mm. Flat plug and piggyback.</p>	<p>190046 Qty. 100 Blue. 1.0 - 2.6 mm². 6.3 mm. Flat plug, fully insulated.</p>	<p>190023 Qty. 100 Blue. 1.0 - 2.6 mm². O.D. 5 mm. Round plug.</p>	<p>190018 Qty. 100 Blue. 1.0 - 2.6 mm². I.D. 5 mm. Round plug receptacle.</p>
<p>190001 Qty. 100 Blue. 1.0 - 2.6 mm². Butt connector.</p>	<p>190034 Qty. 100 Blue. 1.0 - 2.6 mm². 6.0 mm. Ring.</p>	<p>190048 Qty. 50 Yellow. 2.6 - 6.6 mm². 9.5 mm. Flat plug.</p>	<p>190255 Qty. 100 Yellow. 2.6 - 6.6 mm². 8 mm. Ring.</p>

Crimp Terminals w/ Tool - Insulated

804093

190022 Qty. 10 Red. 6.3 mm. Flat plug.	190985 Qty. 10 Red. 6.3 mm. Flat plug, fully isolated.	190019 Qty. 10 Red. 6.3 mm. Flat tongue.	210121 Qty. 1 For insulated terminals. W/wire-cutter.	190001 Qty. 10 Blue. Butt connector.	190032 Qty. 10 Blue. 5.0 mm. Ring.	190953 Qty. 5 Yellow. Pin.
190021 Qty. 10 Red. O.D. 4.0 mm. Round plug.	190017 Qty. 10 Red. I.D. 4.0 mm. Round plugreceptacle.	190028 Qty. 10 Red. Butt connector.		190952 Qty. 5 Blue. Pin.	190024 Qty. 5 Yellow. 6.3 mm. Flat plug.	190051 Qty. 5 Yellow. I.D. 5.0 mm. Round plug.
190031 Qty. 10 Red. 5.0 mm. Ring.	190973 Qty. 10 Red. 4.0 mm. Spade.	190020 Qty. 10 Blue. 6.3 mm. Flat plug.		190050 Qty. 5 Yellow. O.D. 5.0 mm. Round plugreceptacle.	190030 Qty. 5 Yellow. Butt connector.	190035 Qty. 10 Yellow. 6.0 mm. Ring.
190046 Qty. 10 Blue. 6.3 mm. Flat plug, fully isolated.	190016 Qty. 10 Blue. 6.3 mm. Flat tongue.	190026 Qty. 10 Blue. 6.3 mm. Flat plug and piggyback.		190042 Qty. 5 Yellow. 10.0 mm. Ring.	190037 Qty. 10 Blue. 5.0 mm. Spade.	192142 Qty. 10 Yellow. 6.0 mm. Spade.

Ring Crimp Terminals - Insulated

















804015

190257 Qty. 100 Blue. 1.0 - 2.6 mm ² . 3 mm. ring.	190029 Qty. 100 Blue. 1.0 - 2.6 mm ² . 4 mm. ring.	190032 Qty. 100 Blue. 1.0 - 2.6 mm ² . 5 mm. ring.	190034 Qty. 100 Blue. 1.0 - 2.6 mm ² . 6 mm. ring.	190039 Qty. 50 Blue. 1.0 - 2.6 mm ² . 8 mm. ring.
190038 Qty. 100 Red. 0.25 - 1.6 mm ² . 3 mm. ring.	190027 Qty. 100 Red. 0.25 - 1.6 mm ² . 4 mm. ring.	190031 Qty. 100 Red. 0.25 - 1.6 mm ² . 5 mm. ring.	190015 Qty. 100 Red. 0.25 - 1.6 mm ² . 6 mm. ring.	190033 Qty. 50 Yellow. 2.6 - 6.6 mm ² . 5 mm. ring.
190035 Qty. 50 Yellow. 2.6 - 6.6 mm ² . 6 mm. ring.	190255 Qty. 50 Yellow. 2.6 - 6.6 mm ² . 8 mm. ring.	190042 Qty. 50 Yellow. 2.6 - 6.6 mm ² . 10 mm. ring.	190973 Qty. 100 Red. 0.25 - 1.6 mm ² . 4 mm. spade.	190974 Qty. 100 Red. 0.25 - 1.6 mm ² . Pin.
191067 Qty. 100 Blue. 1.0 - 2.6 mm ² . 4 mm. spade.	190037 Qty. 100 Blue. 1.0 - 2.6 mm ² . 5 mm. spade	190952 Qty. 100 Blue. 1.0 - 2.6 mm ² . Pin.	190953 Qty. 50 Yellow. 2.6 - 6.6 mm ² . Pin.	

804055 Crimp Seal Terminals





















Shrinkable w/ glue							
 191009 Qty. 10 Red. 0.25 - 1.6 mm ² . Butt connector.	 191010 Qty. 10 Blue. 1.0 - 2.6 mm ² . Butt connector.	 191011 Qty. 10 Yellow. 2.6 - 6.6 mm ² . Butt connector.	 191682 Qty. 10 Red. 0.25 - 1.6 mm ² . 4 mm. ring.				
 191685 Qty. 10 Blue. 1.0 - 2.6 mm ² . 4 mm. ring.	 191689 Qty. 10 Yellow. 2.6 - 6.6 mm ² . 5 mm. ring.	 191683 Qty. 10 Red. 0.25 - 1.6 mm ² . 5 mm. ring.	 191686 Qty. 10 Blue. 1.0 - 2.6 mm ² . 5 mm. ring.				
 191684 Qty. 10 Red. 0.25 - 1.6 mm ² . 6 mm. ring.	 191687 Qty. 10 Blue. 1.0 - 2.6 mm ² . 6 mm. ring.	 191690 Qty. 10 Yellow. 2.6 - 6.6 mm ² . 6 mm. ring.	 191688 Qty. 10 Blue. 1.0 - 2.6 mm ² . 8 mm. ring.	 191691 Qty. 10 Yellow. 2.6 - 6.6 mm ² . 8 mm. ring.	 191692 Qty. 10 Yellow. 2.6 - 6.6 mm ² . 10 mm. ring.		
 191693 Qty. 10 Red. 0.25 - 1.6 mm ² . 4 mm. spade.	 191694 Qty. 10 Blue. 1.0 - 2.6 mm ² . 4 mm. spade.	 191695 Qty. 10 Blue. 1.0 - 2.6 mm ² . 5 mm. spade.	 191696 Qty. 10 Yellow. 2.6 - 6.6 mm ² . 5 mm. spade.	 191697 Qty. 10 Red. 0.25 - 1.6 mm ² . 6.3 mm. flat plug. Fully insulated.	 191698 Qty. 10 Blue. 1.0 - 2.6 mm ² . 6.3 mm. flat plug. Fully insulated.	 191699 Qty. 10 Red. 0.25 - 1.6 mm ² . 6.3 mm. flat tongue.	 191700 Qty. 10 Blue. 1.0 - 2.6 mm ² . 6.3 mm. flat tongue.

804056 Solder Grip Terminals

W/ fluxed solder and heat shrinkable thermoplastic sleeve							
 191701 Qty. 10 Red code. Cable O.D. max 2.7 mm.	 191702 Qty. 10 Blue code. Cable O.D. max 4.5 mm.	 191703 Qty. 10 Yellow code. Cable O.D. max 6.0 mm.	 191704 Qty. 10 Green code. Max. bundle O.D. max 3.1 mm.				
 191705 Qty. 10 Red code. Max. bundle O.D. max 3.9 mm.	 191706 Qty. 10 Blue code. Max. bundle O.D. max 5.35 mm.	 191707 Qty. 10 Yellow code. Max. bundle O.D. max 7.15 mm.	 191708 Qty. 10 Green code. Max. bundle O.D. max 3.6 mm.				
 191709 Qty. 10 Red code. Max. bundle O.D. max 5.0 mm.	 191710 Qty. 10 Blue code. Max. bundle O.D. max 7.5 mm.	 191711 Qty. 10 Yellow code. Max. bundle O.D. max 9.4 mm.	 191712 Qty. 10 Green code. Ring 4.0 mm. Max. bundle O.D. max 3.9 mm.				
 191713 Qty. 10 Green code. Ring 6.0 mm. Max. bundle O.D. max 3.9 mm.	 191714 Qty. 10 Red code. Ring 6.0 mm. Max. bundle O.D. max 5.4 mm.	 191715 Qty. 10 Red code. Ring 8.0 mm. Max. bundle O.D. max 5.4 mm.	 191716 Qty. 10 Blue code. Ring 8.0 mm. Max. bundle O.D. max 7.6 mm.				















Crimp Terminals - Non-insulated

804013

For Insulators and Multiple Connectors											
 <p>191129 Qty. 100 4.7 mm. 0.5 - 1.5 mm². Male type. W/ non return tag.</p>	 <p>190270 Qty. 100 6.3 mm. 1.0 - 2.5 mm². Male type. W/ non return tag.</p>	 <p>191028 Qty. 100 6.3 mm. 4.0 - 6.0 mm². Male type. W/ non return tag.</p>	 <p>191415 Qty. 100 6.3 mm. 1.0 - 2.5 mm². Male type.</p>	 <p>191083 Qty. 100 2.8 mm. 0.5 - 1.0 mm². Female type. W/ non return tag.</p>	 <p>191089 Qty. 100 4.7 mm. 0.5 - 1.5 mm². Female type. W/ non return tag.</p>	 <p>190868 Qty. 100 6.3 mm. 0.5 - 1.0 mm². Female type. W/ non return tag.</p>	 <p>190252 Qty. 200 6.3 mm. 1.0 - 2.5 mm². Female type. W/ non return tag.</p>				
 <p>191029 Qty. 100 6.3 mm. 2.5 - 6.0 mm². Female type. W/ non return tag.</p>	 <p>191200 Qty. 100 8.0 mm. 1.0 - 2.5 mm². Female type. W/ non return tag. Fits connector Cargo 170619. For bulb holdres.</p>	 <p>191025 Qty. 20 9.5 mm. 2.0 - 4.2 mm². Female type. W/ non return tag.</p>	 <p>191008 Qty. 200 6.3 mm. 1.0 - 2.5 mm². Female type.</p>	 <p>190256 Qty. 20 6.3 mm. 2 flat tongue piggyback. Terminal adaptor.</p>	 <p>191064 Qty. 20 6.3 mm. 2.5 - 6.0 mm². Female type. W/ non return tag.</p>	 <p>191069 Qty. 20 9.5 mm. 2.0 - 4.0 mm². Female type.</p>	 <p>191411 Qty. 20 For blade fuse holder. Female spring terminal. W/ non return tag. To be connected w/ 6.3 mm.</p>	 <p>191412 Qty. 20 For blade fuse holder. Female spring terminal. W/ non return tag. 1.0 - 2.5 mm².</p>	 <p>191413 Qty. 20 For blade fuse holder. Female spring terminal. W/ non return tag. 2.5 - 6.0 mm².</p>	 <p>190725 Qty. 20 6.3 mm. Flag type. For terminal plug Cargo 190733.</p>	 <p>190726 Qty. 20 9.5 mm. Flag type. For terminal plug Cargo 190733.</p>

Pin Terminals - Non Insulated I

804092

 <p>191915 Qty. 50 Dia.: 1.0 mm. W/ non-return tag. Male type, Mini. 0.3 - 0.9 mm².</p>	 <p>191916 Qty. 50 Dia.: 1.0 mm. W/ non-return tag. Female type, Mini. 0.3 - 0.9 mm².</p>	 <p>191985 Qty. 50 Dia.: 1.6 mm. W/ non-return tag. Male type, Mini. 0.75 - 1.5 mm².</p>	 <p>191986 Qty. 50 Dia.: 1.6 mm. W/ non-return tag. Female type, Mini. 0.3 - 0.6 mm².</p>
 <p>191543 Qty. 50 Dia.: 1.6 mm. W/ non-return tag. Male type, Mini. 1.0 - 2.5 mm².</p>	 <p>191544 Qty. 50 Dia.: 1.6 mm. W/ non-return tag. Female type, Mini. 1.0 - 2.5 mm².</p>	 <p>191074 Qty. 50 Dia.: 2.1 mm. W/ non-return tag. Male type, Mini. 1.0 - 2.5 mm².</p>	 <p>191075 Qty. 50 Dia.: 2.1 mm. W/ non-return tag. Female type, Mini. 1.0 - 2.5 mm².</p>
 <p>191091 Qty. 50 Dia.: 2.1 mm. W/ non-return tag. Male type, Mini. 0.5 - 2.1 mm².</p>	 <p>191092 Qty. 50 Dia.: 2.1 mm. W/ non-return tag. Female type, Mini. 0.5 - 2.1 mm².</p>	 <p>191563 Qty. 50 Dia.: 3.5 mm. W/ non-return tag. Male type, Mini. 0.5 - 2.0 mm².</p>	 <p>191564 Qty. 50 Dia.: 3.5 mm. W/ non-return tag. Female type, Mini. 0.5 - 2.0 mm².</p>
 <p>191078 Qty. 50 Male type. 0.5 - 2.5 mm².</p>	 <p>191079 Qty. 50 Female type. 0.5 - 2.5 mm².</p>		

804103 Pin Terminals - Non Insulated II

 191129 Qty. 100 Male type. Flat plug. W/ non-return tag. For insulators and multiple connectors. 4.7 mm. 0.5 - 1.5 mm ² .	 191089 Qty. 100 Female type. Flat receptacle. W/ non-return tag. For multiple connectors. Tinned. 4.7 mm. 0.5 - 1.0 mm ² .	 191681 Qty. 100 Male type. M280 terminal. W/ non-return tag. Universal for car radios. DIN 46343. 0.5 - 1.0 mm ² .	 192217 Qty. 100 Male type. Micro Timer II Terminal. W/ non-return tag. Fits 1.6 x 0.8 mm. tap. 0.5 - 1.0 mm ² .	 192140 Qty. 100 Female type. Micro Timer II Terminal. W/ non-return tag. Fits 1.6 x 0.8 mm. tap. 0.5 - 1.0 mm ² .
 192174 Qty. 100 Male type. Junior Timer Terminal. W/ non-return tag. 2.8 mm. 0.4 - 1.5 mm ² .	 192155 Qty. 100 Female type. Junior Timer Terminal. W/ non-return tag. Fits 2.8 x 0.8 mm. tap. 0.5 - 2.5 mm ² .	 192410 Qty. 100 Male type. Type 070. M 280 terminal. 1.8 mm. 0.5 - 1.25 mm ² .	 192411 Qty. 100 Female type. Type 070. M 280 terminal. 1.8 mm. 0.5 - 1.25 mm ² .	 192156 Qty. 100 Male type. Junior Power Timer terminal. W/ non-return tag. 2.8 mm. 0.5 - 1.0 mm ² .
 192157 Qty. 100 Male type. Junior Power Timer Terminal. W/ non-return tag. 2.8 mm. 1.5 - 2.5 mm ² .	 192176 Qty. 100 Female type. Junior Power Timer Terminal. W/ non-return tag. Fits 2.8 x 0.8 mm. tap. 1.0 - 2.5 mm ² .	 191551 Qty. 100 Female type. Junior Timer Terminal. W/ non-return tag. Fits 2.8 x 0.8 mm. tap. 0.5 - 1.0 mm ² .	 191083 Qty. 100 Female type. Flat receptacle. W/ non-return tag. For multiple connectors. 2.8 mm. 0.5 - 1.0 mm ² .	 192373 Qty. 100 Male type. Metripack. M 280 terminal. 2.8 mm. 0.5 - 1.5 mm ² .
 192240 Qty. 100 Male type. Mark II terminal. 2.8 mm. 0.5 - 1.5 mm ² .	 192239 Qty. 100 Female type. For tail lamps. Mark II terminal. 2.8 mm. 0.5 - 1.5 mm ² .	 192089 Qty. 100 Male type. Super seal connectors. 1.5 mm. 0.5 - 1.0 mm ² .	 192090 Qty. 100 Female type. For seal connectors. 0.5 mm. 0.5 - 1.0 mm ² .	 191807 Qty. 100 Male type. W/ snap-lock for MIC I connectors. 3.0 mm. 1.0 - 3.0 mm ² .
				 191806 Qty. 100 Female type. W/ snap-lock for MIC I connectors. 3.0 mm. 1.0 - 3.0 mm ² .

804054 Cable Joints

 190846 Qty. 50 4-6 mm ² . Ring M6.	 190716 Qty. 20 10 mm ² . Ring M6.	 190719 Qty. 10 25 mm ² . Ring M8.	 190720 Qty. 10 25 mm ² . Ring M10.
 190717 Qty. 20 16 mm ² . Ring M6.	 190718 Qty. 20 16 mm ² . Ring M8.		
 191416 Qty. 10 35 mm ² . Ring M8.	 190721 Qty. 10 35 mm ² . Ring M10.	 190722 Qty. 10 50 mm ² . Ring M8.	 190723 Qty. 10 50 mm ² . Ring M10.

Crimp & Solder Terminals

804061

COPPER TUBE - dib tinned copper to be crimped or soldered					
 191836 Qty. 10 6 mm ² . Ring M8.	 191837 Qty. 10 10 mm ² . Ring M6.	 191838 Qty. 10 10 mm ² . Ring M8.	 191839 Qty. 10 10 mm ² . Ring M10.	 191840 Qty. 10 16 mm ² . Ring M6.	 191841 Qty. 10 16 mm ² . Ring M8.
 191842 Qty. 10 16 mm ² . Ring M10.	 191843 Qty. 10 25 mm ² . Ring M6.	 191844 Qty. 10 25 mm ² . Ring M8.	 191845 Qty. 10 25 mm ² . Ring M10.	 191846 Qty. 10 35 mm ² . Ring M8.	 191847 Qty. 10 35 mm ² . Ring M10.
 191848 Qty. 10 35 mm ² . Ring M12.	 191849 Qty. 10 50 mm ² . Ring M8.	 191850 Qty. 10 50 mm ² . Ring M10.	 191851 Qty. 10 50 mm ² . Ring M12.	 191852 Qty. 8 70 mm ² . Ring M8.	 191853 Qty. 8 70 mm ² . Ring M10.

Butt Splices

804073

 192007 Qty. 100 1.3 mm ² .	 192008 Qty. 100 2 mm ² .	 191885 Qty. 10 6 mm ² .
 191886 Qty. 10 10 mm ² .	 191887 Qty. 10 16 mm ² .	 191888 Qty. 10 25 mm ² .
 191889 Qty. 10 35 mm ² .	 191890 Qty. 10 50 mm ² .	 191891 Qty. 10 70 mm ² .

804085 Cord End Terminals

 191962 Qty. 100 0.5 mm ² . L. 10 mm.	 191963 Qty. 100 0.75 mm ² . L. 10 mm.	 191964 Qty. 100 1.0 mm ² . L. 10 mm.	 191965 Qty. 100 1.5 mm ² . L. 10 mm.	 191966 Qty. 100 2.5 mm ² . L. 10 mm.
 191967 Qty. 100 4.0 mm ² . L. 12 mm.	 191968 Qty. 100 6.0 mm ² . L. 15 mm.	 191969 Qty. 100 10.0 mm ² . L. 15 mm.	 192047 Qty. 100 16.0 mm ² . L. 18 mm.	

804012 Insulator & Multiple Connectors

 191007 Qty. 50 Female holder. W/o non-return tag. White. <i>(Terminal: Cargo 191008 or 191064.)</i>	 191126 Qty. 25 Male holder. White. <i>(Terminal: Cargo 191270 or 191028.)</i>	 191127 Qty. 50 Female holder. White. <i>(Terminal: Cargo 190252 or 191029.)</i>	 191227 Qty. 10 Female holder. White. Japanese style. <i>(Terminal: Cargo 192381.)</i>	 191226 Qty. 10 Male holder. White. Japanese style. <i>(Terminal: Cargo 192380.)</i>	
 190260 Qty. 10 Male holder. White. 2 pole. <i>(Terminal: Cargo 190270 or 191028.)</i>	 190261 Qty. 10 Female holder. White. 2 pole. <i>(Terminal: Cargo 190252 or 191029.)</i>	 190843 Qty. 10 T-type. 2 pole. White. <i>(Terminal: Cargo 190270 or 191028.)</i>	 190272 Qty. 10 Female holder. White. T-type. 2 pole. <i>(Terminal: Cargo 190252 or 191029.)</i>	 191158 Qty. 10 Male holder. Japanese style. 2 pole. White. <i>(Terminal: Cargo 192380.)</i>	 191159 Qty. 10 Female holder. Black. Japanese style. <i>(Terminal: Cargo 192381.)</i>
 190262 Qty. 10 Male holder. 3 pole. White. <i>(Terminal: Cargo 190270 or 191028.)</i>	 190263 Qty. 10 Female holder. 3 pole. White. <i>(Terminal: Cargo 190252 or 191029.)</i>	 191224 Qty. 10 Male holder. Japanese style. 3 pole. White. <i>(Terminal: Cargo 192380.)</i>	 191225 Qty. 10 Female holder. Japanese style. 3 pole. White. <i>(Terminal: Cargo 192381.)</i>		
 190264 Qty. 8 Male holder. 4 pole. White. <i>(Terminal: Cargo 190270 or 191028.)</i>	 190265 Qty. 8 Female holder. 4 pole. White. <i>(Terminal: Cargo 190252 or 191029.)</i>	 190266 Qty. 4 Male holder. 6 pole. White. <i>(Terminal: Cargo 190270 or 191028.)</i>	 190267 Qty. 4 Female holder. 6 pole. White. <i>(Terminal: Cargo 190252 or 191029.)</i>		

Connectors I (Superseal)

804075

<p>192587 Qty. 100 Single wire seal. Colour: Red. For I.D. 1.5 mm.</p>	<p>192091 Qty. 100 Single wire seal. Colour: Yellow. For I.D. 1.5 mm.</p>	<p>192089 Qty. 100 Male type. For seal connectors. 1.5 mm. 1.0 - 1.5 mm².</p>	<p>192090 Qty. 100 Female type. For seal connectors. 1.5 mm. 1.0 - 1.5 mm².</p>	<p>192077 Qty. 5 1-pole. Black. Male holder. (Terminal: Cargo 192089.)</p>	<p>192078 Qty. 5 1-pole. Black. Female holder. (Terminal: Cargo 192090.)</p>
<p>192079 Qty. 5 2-pole. Black. Male holder. (Terminal: Cargo 192089.)</p>	<p>192080 Qty. 5 2-pole. Black. Female holder. (Terminal: Cargo 192090.)</p>	<p>192081 Qty. 5 3-pole. Black. Male holder. (Terminal: Cargo 192089.)</p>	<p>192082 Qty. 5 3-pole. Black. Female holder. (Terminal: Cargo 192090.)</p>		
<p>192083 Qty. 5 4-pole. Black. Male holder. (Terminal: Cargo 192089.)</p>	<p>192084 Qty. 5 4-pole. Black. Female holder. (Terminal: Cargo 192090.)</p>	<p>192085 Qty. 5 5-pole. Black. Male holder. (Terminal: Cargo 192089.)</p>	<p>192086 Qty. 5 5-pole. Black. Female holder. (Terminal: Cargo 192090.)</p>	<p>192087 Qty. 5 6-pole. Black. Male holder. (Terminal: Cargo 192089.)</p>	<p>192088 Qty. 5 6-pole. Black. Female holder. (Terminal: Cargo 192090.)</p>

DT-Connectors

















804100

<p>192477 Qty. 50 Male type. Dia.: 1.5 mm. 1.0 - 2.0 mm². Terminal.</p>	<p>192457 Qty. 3 2-pole connector. Female holder. Grey. Terminal: 192478. Secondary lock: 192467.</p>	<p>192467 Qty. 3 For 2-pole female holder.</p>	<p>192458 Qty. 3 2-pole connector. Male holder. Grey. Terminal: 192477. Secondary lock: 192468.</p>	<p>192468 Qty. 3 For 2-pole male holder.</p>	<p>192459 Qty. 3 3-pole connector. Female holder. Grey. Terminal: 192478. Secondary lock: 192469.</p>	<p>192469 Qty. 3 For 3-pole female holder.</p>	<p>192460 Qty. 3 3-pole connector. Male holder. Grey. Terminal: 192477. Secondary lock: 192470.</p>
<p>192470 Qty. 3 For 3-pole male holder.</p>	<p>192461 Qty. 3 4-pole connector. Female holder. Grey. Terminal: 192478. Secondary lock: 192471.</p>	<p>192471 Qty. 3 For 4-pole female holder.</p>	<p>192462 Qty. 3 4-pole connector. Male holder. Grey. Terminal: 192477. Secondary lock: 192472.</p>	<p>192472 Qty. 3 For 4-pole male holder.</p>	<p>192463 Qty. 3 6-pole connector. Female holder. Grey. Terminal: 192478. Secondary lock: 192473.</p>	<p>192473 Qty. 3 For 6-pole female holder.</p>	
<p>192464 Qty. 3 6-pole connector. Male holder. Grey. Terminal: 192477. Secondary lock: 192474.</p>	<p>192474 Qty. 3 For 6-pole male holder.</p>	<p>192465 Qty. 3 8-pole connector. Female holder. Grey. Terminal: 192478. Secondary lock: 192475.</p>	<p>192475 Qty. 3 For 8-pole female holder.</p>	<p>192466 Qty. 3 8-pole connector. Male holder. Grey. Terminal: 192477. Secondary lock: 192476.</p>			
<p>192478 Qty. 50 Female type. Dia.: 1.5 mm. 1.0 - 2.0 mm². Terminal.</p>	<p>192476 Qty. 3 For 3-pole male holder.</p>	<p>192450 Qty. 3 12-pole connector. Female holder. Grey. Terminal: 192478. Secondary lock: 192452.</p>	<p>192452 Qty. 3 For 12-pole female holder.</p>	<p>192451 Qty. 3 12-pole connector. Male holder. Grey. Terminal: 192477. Secondary lock: 192453.</p>	<p>192453 Qty. 3 For 12-pole male holder.</p>		

804080 Connectors II (Junior Timers)

	 <p>192174 Qty. 100 Junior timer terminal. Male type. 2.8 mm. W/non-return tag. 0.4 - 1.5 mm².</p>	 <p>192166 Qty. 2 Junior timer housing, black. 2-pole. Male holder. (Terminal: Cargo 192174.)</p>	 <p>192146 Qty. 2 Junior timer housing, black. 2-pole. Female holder. (Terminal: Cargo 191551 or 192155. Rubber boot: Cargo 192150 or 192151.)</p>
 <p>191551 Qty. 100 Junior timer terminal. Female type. Fits 2.8 x 0.8 mm. tap. W/non-return tag. 0.5 - 1.5 mm².</p>	 <p>192155 Qty. 100 Junior timer terminal. Female type. Fits 2.8 x 0.8 mm. tap. W/non-return tag. 1.5 - 2.5 mm².</p>		
 <p>192150 Qty. 2 Rubber boot for 2-pole Junior timer connectors. L. 57 mm.</p>	 <p>192151 Qty. 2 Rubber boot for 2-pole Junior timer connectors. L. 37 mm.</p>	 <p>192149 Qty. 2 Junior timer housing, black. 7-pole. Female holder. (Terminal: Cargo 191551 or 192155. Rubber boot: Cargo 192154.)</p>	 <p>192154 Qty. 2 Rubber boot for 7-pole Junior timer connectors. L. 57 mm.</p>

804081 Connectors III (Junior Power Timers)

 <p>192177 Qty. 100 Single wire seal. For I.D. 0.5 - 1.0 mm. Colour : Light blue.</p>	 <p>192178 Qty. 100 Single wire seal. For I.D. 1.5 - 2.5 mm. Colour : White.</p>	 <p>192156 Qty. 100 Male type. 2.8 mm. W/non-return tag. 0.5 - 1.0 mm².</p>	 <p>192175 Qty. 100 Female type. Fits 2.8 x 0.8 mm. tap. W/non-return tag. 0.5 - 1.0 mm².</p>	 <p>192157 Qty. 100 Male type. 2.8 mm. W/non-return tag. 0.5 - 1.0 mm².</p>	 <p>192176 Qty. 100 Female type. Fits 2.8 x 0.8 mm. tap. W/non-return tag. 1.0 - 2.5 mm².</p>	 <p>192167 Qty. 2 Housing. Black. 2-pole. Male holder.</p>
 <p>192147 Qty. 1 Housing. Black. 2-pole. Female holder. For sensors & injectors.</p>	 <p>192168 Qty. 1 Housing. Grey. 2-pole. Female holder. For sensors & injectors.</p>	 <p>192169 Qty. 1 Housing. Yellow. 2-pole. Female holder. For sensors & injectors.</p>	 <p>192170 Qty. 1 Housing. Blue. 2-pole. Female holder. For sensors & injectors.</p>			
 <p>192152 Qty. 4 Rubber boot for 2-pole Junior power timer connector. Angled. For sensors & injectors.</p>	 <p>192171 Qty. 1 Housing. Black. 4-pole. Female holder. For sensors & injectors.</p>	 <p>192172 Qty. 2 Housing. Black. 5-pole. Female holder. For sensors & injectors.</p>	 <p>192173 Qty. 1 Housing. Black. 6-pole. Female holder. For sensors & injectors.</p>			
 <p>192148 Qty. 1 Housing. Black. 3-pole. Female holder. For sensors, potenziometers & injectors.</p>	 <p>192153 Qty. 2 Rubber boot for 3-pole Junior power timer connector. L. 57 mm.</p>					

DTM-Connectors

804107









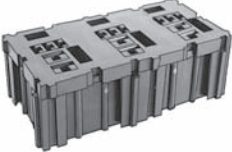

<p>192619 Qty. 50 Male type. Dia.: 1.5 mm. 0.2 - 0.5 mm².</p>	<p>192596 Qty. 3 2-pole. Male holder. (Terminal: Cargo 192619, Secondary lock Cargo 192608.)</p>	<p>192595 Qty. 3 2-pole. Female holder. (Terminal: Cargo 192620, Secondary lock Cargo 192607.)</p>	<p>192608 Qty. 3 For 2-pole male holder.</p>	<p>192607 Qty. 3 For 2-pole female holder.</p>	<p>192598 Qty. 3 3-pole. Male holder. (Terminal: Cargo 192619, Secondary lock Cargo 192610.)</p>	<p>192597 Qty. 3 3-pole. Female holder. (Terminal: Cargo 192620, Secondary lock Cargo 192609.)</p>	<p>192610 Qty. 3 For 3-pole male holder.</p>
<p>192609 Qty. 3 For 3-pole female holder.</p>	<p>192600 Qty. 3 4-pole. Male holder. (Terminal: Cargo 192619, Secondary lock Cargo 192612.)</p>	<p>192599 Qty. 3 4-pole. Female holder. (Terminal: Cargo 192620, Secondary lock Cargo 192611.)</p>	<p>192612 Qty. 3 For 4-pole male holder.</p>	<p>192611 Qty. 3 For 4-pole female holder.</p>	<p>192598 Qty. 3 6-pole. Male holder. (Terminal: Cargo 192619, Secondary lock Cargo 192614.)</p>	<p>192597 Qty. 3 6-pole. Female holder. (Terminal: Cargo 192620, Secondary lock Cargo 192613.)</p>	<p>192614 Qty. 3 For 6-pole male holder.</p>
<p>192613 Qty. 3 For 6-pole female holder.</p>	<p>192620 Qty. 50 Female type. Dia.: 1.5 mm. 0.2 - 0.5 mm².</p>	<p>192604 Qty. 3 8-pole. Male holder. (Terminal: Cargo 192619, Secondary lock Cargo 192616.)</p>	<p>192603 Qty. 3 8-pole. Female holder. (Terminal: Cargo 192620, Secondary lock Cargo 192615.)</p>	<p>192616 Qty. 3 For 8-pole male holder.</p>	<p>192615 Qty. 3 For 8-pole female holder.</p>		
<p>192606 Qty. 3 12-pole. Male holder. (Terminal: Cargo 192619, Secondary lock Cargo 192618.)</p>	<p>192605 Qty. 3 12-pole. Female holder. (Terminal: Cargo 192620, Secondary lock Cargo 192617.)</p>	<p>192618 Qty. 3 For 12-pole male holder.</p>	<p>192617 Qty. 3 For 12-pole female holder.</p>				

Power Connectors & Terminals





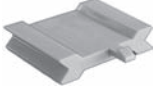
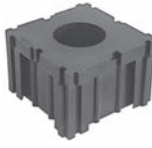





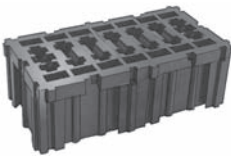

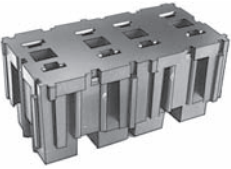

804016

<p>191246 Qty. 50 Female type. 6.3 mm. 0.5 - 1.5 mm². Positive lock, straight type.</p>	<p>191247 Qty. 50 Female type. 6.3 mm. 2.5 - 4 mm². Positive lock, straight type.</p>	<p>191496 Qty. 50 Female type. 4.7 mm. 0.4 - 1.0 mm². Positive lock, straight type.</p>	<p>191248 Qty. 50 Female type. 6.3 mm. 0.5 - 2.5 mm². Positive lock, flag type.</p>		
<p>191260 Qty. 20 Female type. 9.5 mm. 1.0 - 2.5 mm². W/ inox steel clip. For Maxi blade fuse box and power connectors.</p>	<p>191261 Qty. 20 Female type. 9.5 mm. 4.0 - 6.0 mm². W/ inox steel clip. For Maxi blade fuse box and power connectors.</p>	<p>191262 Qty. 20 Female type. 9.5 mm. 6.0 - 10.0 mm². W/ inox steel clip. For Maxi blade fuse box and power connectors.</p>	<p>191263 Qty. 20 Male type. 8.0 mm. 2.5 - 4.0 mm². W/ non-return tag. For power connectors.</p>	<p>191264 Qty. 20 Male type. 8.0 mm. 10.0 - 16.0 mm². W/ non-return tag. For power connectors.</p>	
<p>191405 Qty. 4 Male terminal connector. 1-pole. 150 Amp. (Terminals: Cargo 191263, 191264 or 191983.)</p>	<p>191406 Qty. 4 Female terminal connector. 1-pole. 150 Amp. (Terminals: Cargo 191260, 191261 or 191262.)</p>	<p>191407 Qty. 4 Male terminal connector. 2-pole. 150 Amp. (Terminals: Cargo 191263, 191264 or 191983.)</p>	<p>191408 Qty. 4 Female terminal connector. 2-pole. 150 Amp. (Terminals: Cargo 191260, 191261 or 191262.)</p>		

804082 Powr-Bloks™ I





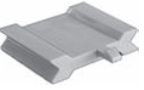





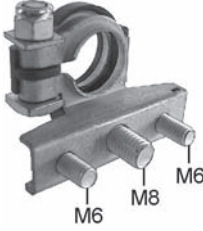
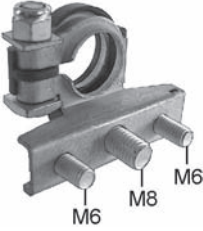

 <p>191722 Qty. 4 ISO Relay module. (Terminals: Cargo 191764, 191765 and 191766).</p>	 <p>191724 Qty. 2 Micro Relay module. (Terminals 6.3 mm.: Cargo 191764, 191765 and 191766. Special terminals: Cargo 191737 and 191738).</p>	 <p>191738 Qty. 50 For use in Micro Relay module Cargo 191724. Female type. 1.5 - 4.0 mm².</p>	 <p>191725 Qty. 2 Stud assembly module 6 mm.</p>	 <p>191731 Qty. 4 Mounting leg. H. 25 mm.</p>	
 <p>191723 Qty. 4 ISO Relay module 2 pcs. (Terminals: Cargo 191764, 191765 and 191766).</p>	 <p>191726 Qty. 50 Power Relay module. (Terminals 6.3 mm.: Cargo 191764, 191765. Terminals 9.5 mm.: Cargo 191025.</p>	 <p>191764 Qty. 50 For use in relay module Cargo 191722, 191723. Female type. 0.5 - 0.8 mm².</p>	 <p>191766 Qty. 50 For use in relay module Cargo 191722, 191723. Female type. 3.3 - 5.5 mm².</p>	 <p>191727 Qty. 40 Block lock.</p>	 <p>191767 Qty. 4 Mounting accessory block designed for mounting fuse block to be used with mounting stand-off.</p>
		 <p>191765 Qty. 50 For use in relay module Cargo 191722, 191723. Female type. 1.3 - 2.1 mm².</p>	 <p>191025 Qty. 25 For use in relay module Cargo 191726. Female type. 2.0 - 4.0 mm².</p>		

804083 Powr-Bloks™ II

 <p>191719 Qty. 2 ATO 7-way fuse box. (Terminals: Cargo 191733 and 191734.)</p>		 <p>191718 Qty. 2 ATO 4-way fuse box. (Terminals: Cargo 191733 and 191734.)</p>		 <p>191717 Qty. 2 ATO 2-way fuse box. (Terminals: Cargo 191733 and 191734.)</p>	 <p>191721 Qty. 2 "Maxi" 4-way fuse box. (Terminals: Cargo 191735 and 191736.)</p>	 <p>191732 Qty. 2 Mounting leg. H. 76.2 mm.</p>
 <p>191743 Qty. 2 7-way bridge. (For fuse module Cargo 191719.)</p>	 <p>191742 Qty. 2 4-way bridge. (For fuse module Cargo 191718.)</p>	 <p>191741 Qty. 2 2-way bridge. (For fuse module Cargo 191717.)</p>	 <p>191735 Qty. 30 For use in Maxi fuses. Female type. 1.5 - 4.0 mm².</p>	 <p>191728 Qty. 2 Mounting stand-off. H. 19 mm.</p>	 <p>191729 Qty. 2 Mounting stand-off. H. 25.4 mm.</p>	 <p>191730 Qty. 2 Mounting stand-off. H. 31.7 mm.</p>
		 <p>191733 Qty. 50 For ATO blade fuses. Female spring terminal. Heavy duty version. 1.0 - 2.5 mm².</p>	 <p>191739 Qty. 50 For use in Mini fuses. Female type. 1.0 - 2.5 mm².</p>	 <p>191740 Qty. 50 For use in Mini fuses. Female type. 2.5 - 4.0 mm².</p>	 <p>191744 Qty. 1 "Mini" fuse module. 191745 Qty. 1 Seal for "mini" fuse module. 191746 Qty. 1 Plast cover for "mini" fuse module.</p>	 <p>191727 Qty. 40 Block lock.</p>









Battery Terminals I

804074

 <p>191820 Qty. 2 POS. 25 - 35 mm². + 2 accessory outlets. (Terminal: Cargo 191822 - 191827.)</p>	 <p>192233 Qty. 2 NEG. 25 - 35 mm². + 2 accessory outlets. (Terminal: Cargo 191822 - 191827.)</p>	 <p>191821 Qty. 2 POS. 3 terminal outlets. (Terminal: Cargo 191822 - 191829.)</p>	 <p>192234 Qty. 2 NEG. 3 terminal outlets. (Terminal: Cargo 191822 - 191829.)</p>	
 <p>191819 Qty. 2 POS. 10 - 20 mm². + 2 accessory. (Terminal: Cargo 191822 - 191827.)</p>	 <p>191822 Qty. 10 Conductor 2.5 - 4.0 mm². Ring 6.2 mm. for battery terminal.</p>	 <p>191824 Qty. 10 Conductor 10.0 - 16.0 mm². Ring 6.2 mm. for battery terminal.</p>	 <p>192076 Qty. 2 NEG. For M8 stud connection. Battery terminal dia.: 17 mm.</p>	
 <p>192232 Qty. 2 NEG. 10 - 20 mm². + 2 accessory. (Terminal: Cargo 191822 - 191827.)</p>	 <p>191823 Qty. 10 Conductor 6.0 - 8.0 mm². Ring 6.2 mm. for battery terminal.</p>	 <p>191826 Qty. 10 Conductor 6.0 - 8.0 mm². Ring 6.2 mm. for battery terminal.</p>	 <p>192074 Qty. 2 NEG. 10 - 20 mm². Battery terminal dia.: 17 mm.</p>	 <p>192075 Qty. 2 NEG. 25 - 35 mm². Battery terminal dia.: 17 mm.</p>

Battery Terminals II

804089

 <p>190012 Qty. 5 POS. 25 - 35 mm².</p>	 <p>190013 Qty. 5 NEG. 25 - 35 mm².</p>	 <p>190202 Qty. 5 POS. 50 mm².</p>	 <p>190203 Qty. 5 NEG. 50 mm².</p>
 <p>190213 Qty. 5 POS. W/ 10 mm. bolt.</p>	 <p>190214 Qty. 5 NEG. W/ 10 mm. bolt.</p>	 <p>190866 Qty. 5 POS. 35 - 95 mm². W/ double screws & screws for aux.</p>	 <p>190867 Qty. 5 NEG. 35 - 95 mm². W/ double screws & screws for aux.</p>

80409 1 Cable Glands - PG I

 <p>192355 Qty. 20 Type: PG 7. Mounting hole: 12.1 mm. Grey. Protecting degree: IP 68.</p>	 <p>192356 Qty. 20 Type: PG 9. Mounting hole: 14.3 mm. Grey. Protecting degree: IP 68.</p>	 <p>192357 Qty. 15 Type: PG 11. Mounting hole: 18.23 mm. Grey. Protecting degree: IP 68.</p>	 <p>192358 Qty. 10 Type: PG 13.5. Mounting hole: 19.9 mm. Grey. Protecting degree: IP 68.</p>
 <p>192359 Qty. 10 Type: PG 16. Mounting hole: 22.1 mm. Grey. Protecting degree: IP 68.</p>	 <p>192360 Qty. 10 Type: PG 21. Mounting hole: 24.5 mm. Grey. Protecting degree: IP 68.</p>		

804108 Cable Glands II

 <p>192483 Qty. 5 Mounting hole: 32.0 mm. Cable range: 18.0 - 25.0 mm. Grey. Protecting degree: IP 68.</p>	 <p>192482 Qty. 8 Mounting hole: 25.0 mm. Cable range: 13.0 - 18.0 mm. Grey. Protecting degree: IP 68.</p>		
 <p>192481 Qty. 8 Mounting hole: 20.0 mm. Cable range: 10.0 - 14.0 mm. Grey. Protecting degree: IP 68.</p>	 <p>192480 Qty. 10 Mounting hole: 16.0 mm. Cable range: 5.0 - 10.0 mm. Grey. Protecting degree: IP 68.</p>	 <p>192479 Qty. 20 Mounting hole: 12.0 mm. Cable range: 3.0 - 6.5 mm. Grey. Protecting degree: IP 68.</p>	

Blade Fuses

804008

 191465 Qty. 10 Grey. 2 Amp. Micro blade type.	 191466 Qty. 10 Violet. 3 Amp. Micro blade type.	 191467 Qty. 10 Pink. 4 Amp. Micro blade type.	 191468 Qty. 10 Tan. 5 Amp. Micro blade type.	 191469 Qty. 10 Brown. 6 Amp. Micro blade type.	 191470 Qty. 10 Red. 10 Amp. Micro blade type.	 191471 Qty. 10 Blue. 15 Amp. Micro blade type.	 191472 Qty. 10 Yellow. 20 Amp. Micro blade type.
 191473 Qty. 10 Natural. 25 Amp. Micro blade type.	 191474 Qty. 10 Green. 30 Amp. Micro blade type.	 191475 Qty. 25 Black. 1 Amp. ATO blade type.	 191476 Qty. 25 Grey. 2 Amp. ATO blade type.	 190053 Qty. 50 Violet. 3 Amp. ATO blade type.		 190054 Qty. 50 Pink. 4 Amp. ATO blade type.	
 190055 Qty. 50 Tan. 5 Amp. ATO blade type.		 190056 Qty. 50 Brown. 7.5 Amp. ATO blade type.		 190057 Qty. 50 Red. 10 Amp. ATO blade type.		 190058 Qty. 50 Blue. 15 Amp. ATO blade type.	
 190059 Qty. 50 Yellow. 20 Amp. ATO blade type.		 190060 Qty. 50 Natural. 25 Amp. ATO blade type.		 190061 Qty. 50 Green. 30 Amp. ATO blade type.		 191664 Qty. 50 Orange. 40 Amp. ATO blade type.	











Continental & Glass Fuses

804036

 190276 Qty. 100 Dim. 25 x 6 mm. 5 Amp. Torpedo type.	 190277 Qty. 100 Dim. 25 x 6 mm. 8 Amp. Torpedo type.		 190278 Qty. 100 Dim. 25 x 6 mm. 16 Amp. Torpedo type.		 190279 Qty. 100 Dim. 25 x 6 mm. 25 Amp. Torpedo type.		
 190280 Qty. 100 Dim. 25 x 6 mm. 40 Amp. Torpedo type.		 190285 Qty. 20 Dim. 20 x 5 mm. 5 Amp. Glass type.	 190286 Qty. 20 Dim. 20 x 5 mm. 2 Amp. Glass type.	 190284 Qty. 20 Dim. 20 x 5 mm. 6 Amp. Glass type.	 190734 Qty. 20 Dim. 20 x 5 mm. 10 Amp. Glass type.	 191534 Qty. 20 Dim. 20 x 5 mm. 20 Amp. Glass type.	 190735 Qty. 20 Dim. 29 x 6.3 mm. 10 Amp. Glass type.
 191570 Qty. 20 Dim. 29 x 6.3 mm. 15 Amp. Glass type.		 190736 Qty. 20 Dim. 29 x 6.3 mm. 25 Amp. Glass type.		 191670 Qty. 20 Dim. 20 x 5.0 mm. 0.63 Amp. Glass type.		 190287 Qty. 20 Dim. 29 x 6.3 mm. 5 Amp. Eng. / Jap. Glass type.	
 190288 Qty. 20 Dim. 32 x 6.3 mm. 10 Amp. Eng. / Jap. Glass type.		 190289 Qty. 20 Dim. 32 x 6.3 mm. 15 Amp. Eng. / Jap. Glass type.		 190274 Qty. 20 Dim. 32 x 6.3 mm. 20 Amp. Eng. / Jap. Glass type.		 190275 Qty. 20 Dim. 32 x 6.3 mm. 35 Amp. Eng. / Jap. Glass type.	









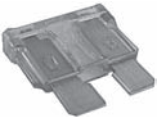

804096

Mini Fuses

 191465 Qty. 10 Grey. 2 Amp.	 191466 Qty. 10 Violet. 3 Amp.	 191467 Qty. 10 Pink. 4 Amp.	 191468 Qty. 10 Tan. 5 Amp.
 191469 Qty. 10 Brown. 7.5 Amp.	 191470 Qty. 10 Red. 10 Amp.	 191471 Qty. 10 Blue. 15 Amp.	 191472 Qty. 10 Yellow. 20 Amp.
 191473 Qty. 10 Natural. 25 Amp.	 191474 Qty. 10 Green. 30 Amp.	 210841 Qty. 1 Extractor for fuses.	

804097







ATO / Mini / Maxi Fuses

 190055 Qty. 20 Tan. 5 Amp. Ato blade type.	 190056 Qty. 20 Brown. 7.5 Amp. Ato blade type.	 190057 Qty. 20 Red. 10 Amp. Ato blade type.	 190058 Qty. 20 Blue. 15 Amp. Ato blade type.	 190059 Qty. 20 Yellow. 20 Amp. Ato blade type.	 190060 Qty. 20 Natural. 25 Amp. Ato blade type.
 190061 Qty. 20 Green. 30 Amp. Ato blade type.	 191468 Qty. 15 Tan. 5 Amp. Mini blade type.	 191469 Qty. 15 Brown. 7 Amp. Mini blade type.	 191470 Qty. 15 Red. 10 Amp. Mini blade type.	 191471 Qty. 15 Blue. 15 Amp. Mini blade type.	 191472 Qty. 15 Yellow. 20 Amp. Mini blade type.
 191473 Qty. 15 Natural. 25 Amp. Mini blade type.	 191474 Qty. 15 Green. 30 Amp. Mini blade type.	 191250 Qty. 3 Green. 30 Amp. Maxi blade type.	 191251 Qty. 3 Orange. 40 Amp. Maxi blade type.	 191252 Qty. 2 Red. 50 Amp. Maxi blade type.	 191253 Qty. 2 Blue. 60 Amp. Maxi blade type.

Maxi Blade Fuses



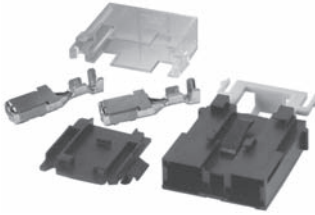

















804106

 <p>191249 Qty. 10 20 Amp. Yellow.</p>	 <p>191250 Qty. 10 30 Amp. Green.</p>	 <p>191251 Qty. 10 40 Amp. Orange.</p>	 <p>191252 Qty. 10 50 Amp. Red.</p>
 <p>191253 Qty. 10 60 Amp. Blue.</p>	 <p>191254 Qty. 10 70 Amp. Beige.</p>	 <p>191256 Qty. 10 100 Amp. Violet.</p>	 <p>191775 Qty. 2 Kit set. Contents: 1 pcs. Cargo 191257. 1 pcs. Cargo 191259. 1 pcs. Cargo 191258. 2 pcs. Cargo 191261.</p>
	 <p>191255 Qty. 10 30 Amp. Green.</p>	 <p>210842 Qty. 1 Extractor. For Maxi fuses.</p>	

ATO / Mini / PAL Fuses

















804098

 <p>190056 Qty. 20 Brown. 7.5 Amp. ATO blade type.</p>	 <p>190057 Qty. 20 Red. 10 Amp. ATO blade type.</p>	 <p>190058 Qty. 20 Blue. 15 Amp. ATO blade type.</p>	 <p>190059 Qty. 20 Yellow. 20 Amp. ATO blade type.</p>	 <p>190061 Qty. 20 Green. 30 Amp. ATO blade type.</p>	 <p>191469 Qty. 15 Brown. 7 Amp. Mini blade type.</p>
 <p>191470 Qty. 15 Red. 10 Amp. Mini blade type.</p>	 <p>191471 Qty. 15 Blue. 15 Amp. Mini blade type.</p>	 <p>191472 Qty. 15 Yellow. 20 Amp. Mini blade type.</p>	 <p>191474 Qty. 15 Green. 30 Amp. Mini blade type.</p>	 <p>191628 Qty. 1 Pink. 30 Amp. 2 fixing screws.</p>	 <p>191629 Qty. 1 Green. 40 Amp. 2 fixing screws.</p>
 <p>191630 Qty. 1 Red. 50 Amp. 2 fixing screws.</p>	 <p>191152 Qty. 1 Pink. 30 Amp. Slow blow fuse.</p>	 <p>191153 Qty. 1 Green. 40 Amp. Slow blow fuse.</p>	 <p>191970 Qty. 1 Red. 50 Amp. Slow blow fuse.</p>	 <p>191830 Qty. 1 Brown. 25 Amp. Slow blow fuse.</p>	 <p>191831 Qty. 1 Green. 30 Amp. Slow blow fuse.</p>

804099 Maxi Fuses

 191249 Qty. 2 Yellow. 20 Amp. Maxi blade type.	 191250 Qty. 3 Green. 30 Amp. Maxi blade type.	 191250 Qty. 3 Green. 30 Amp. Maxi blade type.	 191251 Qty. 3 Orange. 40 Amp. Maxi blade type.
 191251 Qty. 3 Orange. 40 Amp. Maxi blade type.	 191252 Qty. 2 Red. 50 Amp. Maxi blade type.	 191252 Qty. 2 Red. 50 Amp. Maxi blade type.	 191253 Qty. 2 Blue. 60 Amp. Maxi blade type.
 191253 Qty. 2 Blue. 60 Amp. Maxi blade type.	 191254 Qty. 2 Beige. 70 Amp. Maxi blade type.	 191255 Qty. 1 Neutral. 80 Amp. Maxi blade type.	 210842 Qty. 1 Extrator. For maxi Fuses.

804052 Pal Fuses I (Slow Blow Fuses)

 191638 Qty. 1 Blue. 20 Amp.	 191152 Qty. 3 Pink. 30 Amp.	 191153 Qty. 3 Green. 40 Amp.	 191154 Qty. 3 Yellow. 60 Amp.
 191155 Qty. 3 Pink. 30 Amp.	 191156 Qty. 3 Yellow. 60 Amp.	 191157 Qty. 3 Black. 80 Amp.	 191628 Qty. 3 Pink. 30 Amp. Fixing holes (<-> 48 mm.)
 191629 Qty. 3 Green. 40 Amp. Fixing holes (<-> 48 mm.)	 191630 Qty. 3 Red. 50 Amp. Fixing holes (<-> 48 mm.)	 191631 Qty. 3 Yellow. 60 Amp. Fixing holes (<-> 48 mm.)	 191632 Qty. 3 Brown. 70 Amp. Fixing holes (<-> 48 mm.)
 191633 Qty. 2 Pink. 30 Amp. Fixing holes (<-> 36 mm.)	 191634 Qty. 2 Green. 40 Amp. Fixing holes (<-> 36 mm.)	 191635 Qty. 3 Red. 50 Amp. Fixing holes (<-> 36 mm.)	 191636 Qty. 3 Yellow. 60 Amp. Fixing holes (<-> 36 mm.)
 191637 Qty. 3 Brown. 70 Amp. Fixing holes (<-> 36 mm.)			















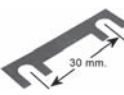
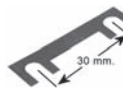
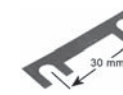
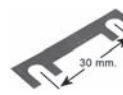

Pal Fuses II (Slow Blow Fuses)

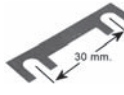
804076









 191638 Qty. 1 Blue. 20 Amp.	 191152 Qty. 1 Pink. 30 Amp.	 191153 Qty. 1 Green. 40 Amp.	 191154 Qty. 1 Yellow. 60 Amp.	 191970 Qty. 1 Red. 50 Amp.	 191832 Qty. 1 Red. 45 Amp.	 191833 Qty. 1 Black. 65 Amp.	 191834 Qty. 1 Grey. 75 Amp.
 191672 Qty. 1 Pink. 30 Amp.	 191673 Qty. 1 Green. 40 Amp.	 191830 Qty. 1 Blue. 20 Amp.	 191831 Qty. 1 Green. 30 Amp.	 191155 Qty. 1 Pink. 30 Amp.	 191973 Qty. 1 Green. 40 Amp.	 191974 Qty. 1 Red. 50 Amp.	 191156 Qty. 1 Yellow. 60 Amp.
 191975 Qty. 1 Brown. 70 Amp.	 191157 Qty. 1 Black. 80 Amp.	 191971 Qty. 1 Darkblue. 100 Amp.	 191628 Qty. 1 Pink. 30 Amp. Fixing holes (<-> 48 mm.)	 191629 Qty. 1 Green. 40 Amp. Fixing holes (<-> 48 mm.)	 191630 Qty. 1 Red. 50 Amp. Fixing holes (<-> 48 mm.)	 191631 Qty. 1 Yellow. 60 Amp. Fixing holes (<-> 48 mm.)	 191632 Qty. 1 Brown. 70 Amp. Fixing holes (<-> 48 mm.)
 191972 Qty. 1 Black. 80 Amp. Fixing holes (<-> 48 mm.)	 191977 Qty. 1 Darkblue. 100 Amp. Fixing holes (<-> 48 mm.)	 191633 Qty. 1 Pink. 30 Amp. Fixing holes (<-> 36 mm.)	 191634 Qty. 1 Green. 40 Amp. Fixing holes (<-> 36 mm.)	 191635 Qty. 1 Red. 50 Amp. Fixing holes (<-> 36 mm.)	 191636 Qty. 1 Yellow. 60 Amp. Fixing holes (<-> 36 mm.)	 191637 Qty. 1 Brown. 70 Amp. Fixing holes (<-> 36 mm.)	 191976 Qty. 1 Black. 80 Amp. 191978 Qty. 1 Dark blue. 100 Amp.

Special Fuses







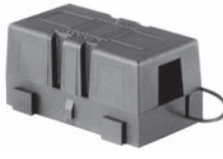

804032

 191152 Qty. 5 Slow blow fuse. For Japanese Vehicles. Pink. 30 Amp.	 191153 Qty. 5 Slow blow fuse. For Japanese Vehicles. Green. 40 Amp.	 191154 Qty. 5 Slow blow fuse. For Japanese Vehicles. Yellow. 60 Amp.	 191155 Qty. 5 Slow blow fuse. Pink. 30 Amp.
 191156 Qty. 5 Slow blow fuse. Yellow. 60 Amp.	 191157 Qty. 5 Slow blow fuse. Black. 80 Amp.	 191184 Qty. 10 Strip type. 30 Amp.	 191185 Qty. 10 Strip type. 40 Amp.
 191186 Qty. 10 Strip type. 50 Amp.	 191187 Qty. 10 Strip type. 60 Amp.	 191188 Qty. 10 Strip type. 80 Amp.	 191189 Qty. 10 Strip type. 100 Amp.
 191249 Qty. 5 Maxi blade type. Yellow. 20 Amp.	 191250 Qty. 5 Maxi blade type. Green. 30 Amp.	 191251 Qty. 5 Maxi blade type. Orange. 40 Amp.	
 191252 Qty. 5 Maxi blade type. Red. 50 Amp.	 191253 Qty. 5 Maxi blade type. Blue. 60 Amp.	 191254 Qty. 5 Maxi blade type. Beige. 70 Amp.	 191255 Qty. 5 Maxi blade type. Natural. 80 Amp.
 191256 Qty. 5 Maxi blade type. Violet. 100 Amp.			

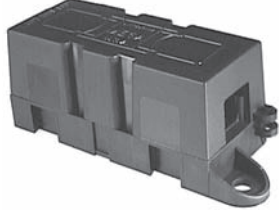
804094 **Midi Fuses**

 <p>192427 Qty. 3 Type: Pink. 30 Amp.</p>	 <p>192428 Qty. 3 Type: Green. 40 Amp.</p>	 <p>192429 Qty. 3 Type: Red. 50 Amp.</p>	 <p>192430 Qty. 3 Type: Yellow. 60 Amp.</p>
 <p>192431 Qty. 3 Type: Brown. 70 Amp.</p>	 <p>192432 Qty. 3 Type: White. 80 Amp.</p>	 <p>192433 Qty. 3 Type: Blue. 100 Amp.</p>	 <p>192434 Qty. 3 Type: Tan. 125 Amp.</p>
 <p>192435 Qty. 3 Type: White. 150 Amp.</p>	 <p>192436 Qty. 2 Fuse holder for midi fuses.</p>		

804086 **Mega Fuses**

 <p>192049 Qty. 3 Type: Yellow. 100 Amp.</p>	 <p>192053 Qty. 3 Type: Blue. 200 Amp.</p>	 <p>192055 Qty. 2 Fuse holder for Mega fuses. (Terminals: M8.)</p>
 <p>192050 Qty. 3 Type: Green. 125 Amp.</p>	 <p>192229 Qty. 3 Type: Brown. 225 Amp.</p>	
 <p>192051 Qty. 3 Type: Tan. 150 Amp.</p>	 <p>192230 Qty. 3 Type: Pink. 250 Amp.</p>	
 <p>192052 Qty. 3 Type: White. 175 Amp.</p>	 <p>192231 Qty. 3 Type: Grey. 300 Amp.</p>	

Compact fuses



804104















192538 Qty. 2 W/ ceramic body. For rated voltage up to 58 V. DIN 72581/3F. 50 Amp.	192539 Qty. 2 W/ ceramic body. For rated voltage up to 58 V. DIN 72581/3F. 75 Amp.	192540 Qty. 2 W/ ceramic body. For rated voltage up to 58 V. DIN 72581/3F. 100 Amp.	192541 Qty. 2 W/ ceramic body. For rated voltage up to 58 V. DIN 72581/3F. 125 Amp.	192542 Qty. 2 W/ ceramic body. For rated voltage up to 58 V. DIN 72581/3F. 150 Amp.	192543 Qty. 2 W/ ceramic body. For rated voltage up to 58 V. DIN 72581/3F. 175 Amp.	192544 Qty. 2 W/ ceramic body. For rated voltage up to 58 V. DIN 72581/3F. 200 Amp.	192545 Qty. 2 W/ ceramic body. For rated voltage up to 58 V. DIN 72581/3F. 250 Amp.
192546 Qty. 2 W/ ceramic body. For rated voltage up to 58 V. DIN 72581/3F. 300 Amp.	192547 Qty. 2 Battery terminal for 1 fuse. POS. Tin plated.	192548 Qty. 2 Battery terminal for 2 fuses. POS. Tin plated.	192549 Qty. 5 Insulating nut for compact fuses.	190718 Qty. 4 16 mm ² . Ring M8. Cable joint.	190719 Qty. 4 25 mm ² . Ring M8. Cable joint.	191416 Qty. 4 35 mm ² . Ring M8. Cable joint.	

Fuses - Strip Type















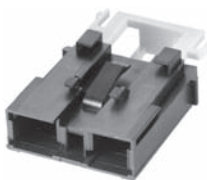

804090

Big Type, Fork.: 11 mm., DIN 43560			
192305 Qty. 5 35 Amp.	192306 Qty. 5 50 Amp.	192307 Qty. 5 80 Amp.	192308 Qty. 5 100 Amp.
192309 Qty. 5 125 Amp.	192310 Qty. 5 160 Amp.	192311 Qty. 5 200 Amp.	192312 Qty. 5 250 Amp.
192313 Qty. 5 300 Amp.	192314 Qty. 5 355 Amp.		
		192344 Qty. 2 Fuse holder. For DIN 43560 strip fuses W/o fuse. Single.	
192315 Qty. 5 425 Amp.	192316 Qty. 5 500 Amp.		

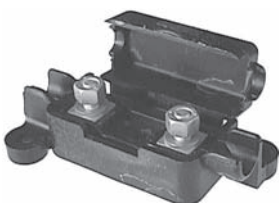









804102 Fuses - Strip (Closed) Type

Big Type, Fork.: 11 mm., DIN 43560				
 192325 Qty. 5 35 Amp.	 192326 Qty. 5 50 Amp.	 192327 Qty. 5 80 Amp.	 192328 Qty. 5 100 Amp.	
 192329 Qty. 5 125 Amp.	 192330 Qty. 5 160 Amp.	 192331 Qty. 5 200 Amp.	 192332 Qty. 5 250 Amp.	
 192333 Qty. 5 275 Amp.	 192334 Qty. 5 300 Amp.	 192335 Qty. 5 335 Amp.	 192344 Qty. 2 Fuse holder. For DIN 43560 strip fuses. W/o fuses. Single.	
 192336 Qty. 5 425 Amp.	 192337 Qty. 5 500 Amp.			

804033 Fuse Holders

 190273 Qty. 10 For torpedo fuses. W/ 8 Amp fuse. Screw terminals.	 190787 Qty. 5 For torpedo fuses. W/ 8 Amp fuse. Flat tongue terminals.	 190768 Qty. 2 Transparent cover. W/ 8 Amp torpedo fuse. Screw terminals. 2-way fuse box.	 190770 Qty. 1 Transparent cover. W/ 8 Amp torpedo fuse. Screw terminals. 4-way fuse box.
 191258 Qty. 5 Cover for fuse box Cargo 191257.	 191259 Qty. 5 Fixing plate for Cargo 191257.	 191260 Qty. 10 Female type. 9.5 mm. 1.0 - 2.5 mm ² . W/ inox steel clip.	 191001 Qty. 5 For ATO blade fuses. Flat tongue terminals. Can be assembled in rows.
 191257 Qty. 5 For ATO blade fuses. Can be assembled in rows. Supplied w/o terminal. (Terminals: Cargo 191260, 191261 or 191262. (2 pcs.))	 191261 Qty. 10 Female type. 9.5 mm. 4.0 - 6.0 mm ² . W/ inox steel clip.	 191190 Qty. 4 For strip link fuses. W/o fuses. W/ screws and washers.	 191053 Qty. 5 Fixing plate for Cargo 191054.
	 191262 Qty. 10 Female type. 9.5 mm. 6.0 - 10.0 mm ² . W/ inox steel clip.		 191055 Qty. 5 Cover for fuse-box Cargo 191054.
		 190957 Qty. 5 For radio glass fuses. W/ 2 Amp. radiofuse.	 191054 Qty. 5 For ATO blade fuses. Can be assembled in rows. Flat tongue terminal.

ATO-blade Fuse Holder **804105**

 <p>192631 Qty. 3 Fuse holder. Colour code: Tan for 5 Amp. fuses. (Terminal: Cargo 191870, 191871 or 191872. Single wire seal: 192647.</p>	 <p>192632 Qty. 3 Fuse holder. Colour code: Brown for 7.5 Amp. fuses. (Terminal: Cargo 191870, 191871 or 191872. Single wire seal: 192647.</p>	 <p>192633 Qty. 3 Fuse holder. Colour code: Red for 10 Amp. fuses. (Terminal: Cargo 191870, 191871 or 191872. Single wire seal: 192647.</p>	 <p>192634 Qty. 3 Fuse holder. Colour code: Blue for 15 Amp. fuses. (Terminal: Cargo 191870, 191871 or 191872. Single wire seal: 192647.</p>
 <p>192635 Qty. 3 Fuse holder. Colour code: Yellow for 20 Amp. fuses. (Terminal: Cargo 191870, 191871 or 191872. Single wire seal: 192647.</p>	 <p>192636 Qty. 3 Fuse holder. Colour code: Beige for 25 Amp. fuses. (Terminal: Cargo 191870, 191871 or 191872. Single wire seal: 192647.</p>	 <p>192637 Qty. 3 Fuse holder. Colour code: Green for 30 Amp. fuses. (Terminal: Cargo 191870, 191871 or 191872. Single wire seal: 192647.</p>	
 <p>191870 Qty. 100 For blade fuse holder. Spring terminal w/ non-return tag. Heavy-duty version. 1.0 - 1.5 mm².</p>	 <p>191871 Qty. 100 For blade fuse holder. Spring terminal w/ non-return tag. Heavy-duty version. 2.5 - 4.0 mm².</p>	 <p>191872 Qty. 100 For blade fuse holder. Spring terminal w/ non-return tag. Heavy-duty version. 4.0 - 6.0 mm².</p>	 <p>192647 Qty. 100 Single wire seal. For fuse holder. Hole size: 8.2 mm. Colour white².</p>
 <p>191259 Qty. 3 Fixing plate.</p>	 <p>192638 Qty. 3 Fixing plate. Fixing w/ one screw. For Cargo 191257, 192631 -637.</p>	 <p>192639 Qty. 3 Fixing plate. Fixing w/ two screws. For Cargo 191257, 192631 -637.</p>	

Display w/ Single Core Cables **804078**



190697
Qty. 100 m.
Black.

190698
Qty. 100 m.
Red.





















190699
Qty. 100 m.
Blue.

190700
Qty. 100 m.
Yellow.

190702
Qty. 100 m.
Green.

1.5 mm². • 30 / 0.25 mm. • 16 Amp.

804084 Cable Markers

 192016 Qty. 100 No. 0. Plastic cable markers for 0.75-1.00 mm ² cable.	 192017 Qty. 100 No. 1. Plastic cable markers for 0.75-1.00 mm ² cable.	 192018 Qty. 100 No. 2. Plastic cable markers for 0.75-1.00 mm ² cable.	 192019 Qty. 100 No. 3. Plastic cable markers for 0.75-1.00 mm ² cable.	 192020 Qty. 100 No. 4. Plastic cable markers for 0.75-1.00 mm ² cable.	 192021 Qty. 100 No. 5. Plastic cable markers for 0.75-1.00 mm ² cable.	 192022 Qty. 100 No. 6. Plastic cable markers for 0.75-1.00 mm ² cable.	 192023 Qty. 100 No. 7. Plastic cable markers for 0.75-1.00 mm ² cable.
 192024 Qty. 100 No. 8. Plastic cable markers for 0.75-1.00 mm ² cable.	 192025 Qty. 100 No. 9. Plastic cable markers for 0.75-1.00 mm ² cable.	 192026 Qty. 100 No. 0. Plastic cable markers for 1.25-2.00 mm ² cable.	 192027 Qty. 100 No. 1. Plastic cable markers for 1.25-2.00 mm ² cable.	 192028 Qty. 100 No. 2. Plastic cable markers for 1.25-2.00 mm ² cable.	 192029 Qty. 100 No. 3. Plastic cable markers for 1.25-2.00 mm ² cable.	 192030 Qty. 100 No. 4. Plastic cable markers for 1.25-2.00 mm ² cable.	 192031 Qty. 100 No. 5. Plastic cable markers for 1.25-2.00 mm ² cable.
 192032 Qty. 100 No. 6. Plastic cable markers for 1.25-2.00 mm ² cable.	 192033 Qty. 100 No. 7. Plastic cable markers for 1.25-2.00 mm ² cable.	 192034 Qty. 100 No. 8. Plastic cable markers for 1.25-2.00 mm ² cable.	 192035 Qty. 100 No. 9. Plastic cable markers for 1.25-2.00 mm ² cable.				

804077 Display w/ Thermoshrinking Pipes



192069

Box qty. 10 m.
 Before crimp 2.4 mm.
 After crimp 1.2 mm.

191874

Box qty. 9 m.
 Before crimp 3.2 mm.
 After crimp 1.6 mm.

191875

Box qty. 9 m.
 Before crimp 4.8 mm.
 After crimp 2.4 mm.

191876

Box qty. 8 m.
 Before crimp 6.4 mm.
 After crimp 3.2 mm.

191877

Box qty. 6 m.
 Before crimp 9.5 mm.
 After crimp 4.8 mm.

191878

Box qty. 5 m.
 Before crimp 12.7 mm.
 After crimp 6.4 mm.

191879

Box qty. 4 m.
 Before crimp 19.0 mm.
 After crimp 9.5 mm.

191880

Box qty. 3 m.
 Before crimp 25.4 mm.
 After crimp 12.7 mm.

Shrinking temp. 120°-250° C

Shrink ration 2:1

Supplied in mini box (17 x 17 x 5.5 cm)

Display w/ Thermoshrinking Pipes w/ Glue

804101



191892
Box qty. 5 m.
Before crimp 3 mm.
After crimp 1 mm.

191893
Box qty. 3.5 m.
Before crimp 6 mm.
After crimp 2 mm.

191894
Box qty. 3 m.
Before crimp 9 mm.
After crimp 3 mm.

191895
Box qty. 2.5 m.
Before crimp 12 mm.
After crimp 4 mm.

















191896
Box qty. 2 m.
Before crimp 18 mm.
After crimp 6 mm.

191897
Box qty. 1.5 m.
Before crimp 24 mm.
After crimp 8 mm.

Shrinking temp. 110°-200° C
Shrink ration 3:1
Supplied in mini box (17 x 17 x 5.5 cm.)

Thermoshrinking Pipes w/wo Glue - Length 20 cm

804062

 190886 Qty. 5 Shrinking temp. 120° - 250° C. Shrink rotation 2:1. Before crimp 3.2 mm. After crimp 1.6 mm. L. 0.2 mm.	 190888 Qty. 5 Shrinking temp. 120° - 250° C. Shrink rotation 2:1. Before crimp 6.4 mm. After crimp 3.2 mm. L. 0.2 mm.	 190890 Qty. 5 Shrinking temp. 120° - 250° C. Shrink rotation 2:1. Before crimp 12.7 mm. After crimp 6.4 mm. L. 0.2 mm.	 191652 Qty. 5 Shrinking temp. 120° - 250° C. Shrink rotation 2:1. Before crimp 25.4 mm. After crimp 12.7 mm. L. 0.2 mm.
 190887 Qty. 5 Shrinking temp. 120° - 250° C. Shrink rotation 2:1. Before crimp 4.8 mm. After crimp 2.4 mm. L. 0.2 mm.	 190889 Qty. 5 Shrinking temp. 120° - 250° C. Shrink rotation 2:1. Before crimp 9.6 mm. After crimp 4.8 mm. L. 0.2 mm.	 190891 Qty. 5 Shrinking temp. 120° - 250° C. Shrink rotation 2:1. Before crimp 19 mm. After crimp 9.6 mm. L. 0.2 mm.	 191652 Qty. 5 Shrinking temp. 120° - 250° C. Shrink rotation 2:1. Before crimp 25.4 mm. After crimp 12.7 mm. L. 0.2 mm.
 191905 Qty. 5 Shrinking temp. 100° - 200° C. Shrink rotation 3:1. W/ glue. Before crimp 3 mm. After crimp 1 mm. L. 0.2 mm.	 191907 Qty. 5 Shrinking temp. 100° - 200° C. Shrink rotation 3:1. W/ glue. Before crimp 9 mm. After crimp 3 mm. L. 0.2 mm.	 191909 Qty. 5 Shrinking temp. 100° - 200° C. Shrink rotation 3:1. W/ glue. Before crimp 18 mm. After crimp 6 mm. L. 0.2 mm.	 191910 Qty. 5 Shrinking temp. 100° - 200° C. Shrink rotation 3:1. W/ glue. Before crimp 24 mm. After crimp 8 mm. L. 0.2 mm.
 191906 Qty. 5 Shrinking temp. 100° - 200° C. Shrink rotation 3:1. W/ glue. Before crimp 6 mm. After crimp 2 mm. L. 0.2 mm.	 191908 Qty. 5 Shrinking temp. 100° - 200° C. Shrink rotation 3:1. W/ glue. Before crimp 12 mm. After crimp 4 mm. L. 0.2 mm.	 191909 Qty. 5 Shrinking temp. 100° - 200° C. Shrink rotation 3:1. W/ glue. Before crimp 18 mm. After crimp 6 mm. L. 0.2 mm.	 191910 Qty. 5 Shrinking temp. 100° - 200° C. Shrink rotation 3:1. W/ glue. Before crimp 24 mm. After crimp 8 mm. L. 0.2 mm.

804021 Cable Clips I (Rubber profile 12.7 mm. - Fixing hole 6.8 mm.)







 190899 Qty. 10 Rubber profile 12.7 mm, fixing hole 6.8 mm. Pipe O.D. 12.7 mm. Type 6.	 190900 Qty. 10 Rubber profile 12.7 mm, fixing hole 6.8 mm. Pipe O.D. 7.9 mm. Type 8.	 190901 Qty. 10 Rubber profile 12.7 mm, fixing hole 6.8 mm. Pipe O.D. 9.5 mm. Type 10.	 190902 Qty. 10 Rubber profile 12.7 mm, fixing hole 6.8 mm. Pipe O.D. 11.1 mm. Type 11.
 190903 Qty. 5 Rubber profile 12.7 mm, fixing hole 6.8 mm. Pipe O.D. 12.7 mm. Type 13.	 190904 Qty. 5 Rubber profile 12.7 mm, fixing hole 6.8 mm. Pipe O.D. 14.3 mm. Type 14.	 190905 Qty. 5 Rubber profile 12.7 mm, fixing hole 6.8 mm. Pipe O.D. 15.9 mm. Type 16.	 190906 Qty. 5 Rubber profile 12.7 mm, fixing hole 6.8 mm. Pipe O.D. 17.5 mm. Type 18.
 190907 Qty. 5 Rubber profile 12.7 mm, fixing hole 6.8 mm. Pipe O.D. 19 mm. Type 19.	 190908 Qty. 5 Rubber profile 12.7 mm, fixing hole 6.8 mm. Pipe O.D. 22.2 mm. Type 22.	 190909 Qty. 5 Rubber profile 12.7 mm, fixing hole 6.8 mm. Pipe O.D. 25.4 mm. Type 25.	 191417 Qty. 5 Rubber profile 12.7 mm, fixing hole 6.8 mm. Pipe O.D. 28.6 mm. Type 29.

804070 Cable Clips II (Black Plastic, fixing hole 4.6 mm.)

 191950 Qty. 100 Pipe O.D. 3.2 mm. L. 9.5 mm.	 191952 Qty. 50 Pipe O.D. 6.4 mm. L. 12 mm.		
 191951 Qty. 100 Pipe O.D. 4.8 mm. L. 10.5 mm.	 191953 Qty. 50 Pipe O.D. 7.9 mm. L. 12 mm.	 191954 Qty. 50 Pipe O.D. 9.5 mm. L. 12.5 mm.	 191955 Qty. 30 Pipe O.D. 12.7 mm. L. 15.2 mm.
 191956 Qty. 30 Pipe O.D. 15.8 mm. L. 18.2 mm.	 191957 Qty. 30 Pipe O.D. 19.4 mm. L. 18.2 mm.	 191958 Qty. 20 Pipe O.D. 25.4 mm. L. 22 mm.	 191959 Qty. 15 Pipe O.D. 31.8 mm. L. 26.2 mm.











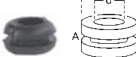
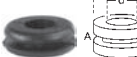





Cable Ties

804024









<p>191003 Qty. 200 L. 102 mm. W 2.5 mm. Max. dia. 25 mm.</p> 		 <p>190014 Qty. 100 For cable ties. Self-adhesive 27 x 27 mm. Max width of cable ties: 5 mm.</p>
<p>190188 Qty. 100 L. 150 mm. W 3.6 mm. Max. dia. 39 mm.</p> 	<p>191128 Qty. 200 L. 92 mm. W 2.4 mm. Max. dia. 16 mm. Heat resistant.</p>	
<p>190248 Qty. 100 L. 190 mm. W 4.8 mm. Max. dia. 52 mm.</p> 		
<p>191094 Qty. 200 L. 200 mm. W 2.5 mm. Max. dia. 55 mm.</p> 		

Rubber Grommets & Blankings

804022

 <p>190964 Qty. 20 d. 5.5 mm. D. 8.0 mm. A 1.6 mm.</p>	 <p>190120 Qty. 20 d. 6.4 mm. D. 9.5 mm. A 1.6 mm.</p>	 <p>190965 Qty. 20 d. 8.0 mm. D. 9.5 mm. A 1.6 mm.</p>	 <p>190966 Qty. 20 d. 8.0 mm. D. 11.0 mm. A 1.6 mm.</p>	 <p>190967 Qty. 20 d. 8.0 mm. D. 12.5 mm. A 1.6 mm.</p>
 <p>190122 Qty. 20 d. 9.5 mm. D. 12.5 mm. A 1.6 mm.</p>	 <p>190968 Qty. 20 d. 11.0 mm. D. 14.2 mm. A 1.6 mm.</p>	 <p>190969 Qty. 20 d. 12.5 mm. D. 17.5 mm. A 1.6 mm.</p>	 <p>190970 Qty. 20 d. 12.5 mm. D. 19.0 mm. A 1.6 mm.</p>	
 <p>190110 Qty. 20 d. 6.4 mm. C 9.5 mm. D. 9.5 mm. A 1.6 mm.</p>	 <p>190111 Qty. 20 d. 8.0 mm. C 10.6 mm. D. 14.2 mm. A 1.6 mm.</p>	 <p>190112 Qty. 20 d. 9.5 mm. C 12.8 mm. D. 15.4 mm. A 1.6 mm.</p>	 <p>190114 Qty. 20 d. 12.5 mm. C 15.5 mm. D. 18.7 mm. A 1.6 mm.</p>	
 <p>190115 Qty. 20 d. 15.5 mm. C 19.0 mm. D. 22.0 mm. A 1.6 mm.</p>	 <p>190116 Qty. 20 d. 19.0 mm. C 22.1 mm. D. 25.5 mm. A 1.6 mm.</p>	 <p>190958 Qty. 10 d. 22.5 mm. C 27.0 mm. D. 28.5 mm. A 1.6 mm.</p>	 <p>190959 Qty. 10 d. 25.4 mm. C 28.3 mm. D. 32.0 mm. A 1.6 mm.</p>	

804040 **Mini Clamps**

 <p>190005 Qty. 15 Carbon steel. Alu / zinc. Coated band width 9 mm. 7 mm. screw. Min. 6 mm. Max. 8.3 mm. Ref. no. 8.</p>	 <p>190006 Qty. 15 Carbon steel. Alu / zinc. Coated band width 9 mm. 7 mm. screw. Min. 7 mm. Max. 9.3 mm. Ref. no. 9.</p>	 <p>190007 Qty. 15 Carbon steel. Alu / zinc. Coated band width 9 mm. 7 mm. screw. Min. 6 mm. Max. 10.3 mm. Ref. no. 8.</p>	 <p>190008 Qty. 15 Carbon steel. Alu / zinc. Coated band width 9 mm. 7 mm. screw. Min. 9 mm. Max. 11.3 mm. Ref. no. 11.</p>
 <p>190009 Qty. 10 Carbon steel. Alu / zinc. Coated band width 9 mm. 7 mm. screw. Min. 9 mm. Max. 12.3 mm. Ref. no. 12.</p>	 <p>190010 Qty. 10 Carbon steel. Alu / zinc. Coated band width 9 mm. 7 mm. screw. Min. 10 mm. Max. 13.3 mm. Ref. no. 13.</p>	 <p>190937 Qty. 10 Carbon steel. Alu / zinc. Coated band width 9 mm. 7 mm. screw. Min. 11 mm. Max. 14.3 mm. Ref. no. 14.</p>	 <p>190938 Qty. 10 Carbon steel. Alu / zinc. Coated band width 9 mm. 7 mm. screw. Min. 12 mm. Max. 15.3 mm. Ref. no. 15.</p>

804069 **Tapping Screws I**

 <p>191753 Qty. 200 Pozidriv, pan head. El-plated. DIN 7981C, ISO 7049. Dim. 3.5 x 16 mm. Type no. 4.</p>	 <p>191798 Qty. 200 Pozidriv, pan head. El-plated. DIN 7981C, ISO 7049. Dim. 2.9 x 19 mm. Type no. 4.</p>	 <p>190360 Qty. 200 Pozidriv, pan head. El-plated. DIN 7981C, ISO 7049. Dim. 3.5 x 9.5 mm. Type no. 6.</p>	 <p>190367 Qty. 200 Pozidriv, pan head. El-plated. DIN 7981C, ISO 7049. Dim. 4.2 x 16 mm. Type no. 8.</p>
 <p>190361 Qty. 200 Pozidriv, pan head. El-plated. DIN 7981C, ISO 7049. Dim. 3.5 x 16 mm. Type no. 6.</p>	 <p>190362 Qty. 200 Pozidriv, pan head. El-plated. DIN 7981C, ISO 7049. Dim. 3.5 x 19 mm. Type no. 6.</p>	 <p>190366 Qty. 200 Pozidriv, pan head. El-plated. DIN 7981C, ISO 7049. Dim. 4.2 x 9.5 mm. Type no. 8.</p>	<p>190367 Qty. 200 Pozidriv, pan head. El-plated. DIN 7981C, ISO 7049. Dim. 4.2 x 16 mm. Type no. 8.</p>
 <p>190368 Qty. 200 Pozidriv, pan head. El-plated. DIN 7981C, ISO 7049. Dim. 4.2 x 19 mm. Type no. 8.</p>	 <p>190371 Qty. 200 Pozidriv, pan head. El-plated. DIN 7981C, ISO 7049. Dim. 4.2 x 25 mm. Type no. 8.</p>	 <p>190372 Qty. 200 Pozidriv, pan head. El-plated. DIN 7981C, ISO 7049. Dim. 4.8 x 13 mm. Type no. 10.</p>	 <p>190373 Qty. 200 Pozidriv, pan head. El-plated. DIN 7981C, ISO 7049. Dim. 4.8 x 19 mm. Type no. 10.</p>

Tapping Screws II (Black)

804079

 <p>210859 Qty. 2 Type 1. L. 25 mm. 1/4" PZ bits.</p>	 <p>210860 Qty. 2 Type 2. L. 25 mm. 1/4" PZ optitor bits.</p>	 <p>192113 Qty. 200 Pozidriv, pan head. Zinc plated black. DIN 7981, ISO 7049. Dim. 3.5 x 9.5 mm. Type no. 6.</p>	 <p>192114 Qty. 200 Pozidriv, pan head. Zinc plated black. DIN 7981, ISO 7049. Dim. 3.5 x 13.0 mm. Type no. 6.</p>	 <p>192115 Qty. 200 Pozidriv, pan head. Zinc plated black. DIN 7981, ISO 7049. Dim. 3.5 x 16.0 mm. Type no. 6.</p>
 <p>192116 Qty. 200 Pozidriv, pan head. Zinc plated black. DIN 7981, ISO 7049. Dim. 4.2 x 9.5 mm. Type no. 8.</p>	 <p>192117 Qty. 200 Pozidriv, pan head. Zinc plated black. DIN 7981, ISO 7049. Dim. 4.2 x 13.0 mm. Type no. 8.</p>	 <p>192118 Qty. 200 Pozidriv, flat head. Zinc plated black. DIN 7982, ISO 7050. Dim. 2.9 x 9.5 mm. Type no. 4.</p>	 <p>192119 Qty. 200 Pozidriv, flat head. Zinc plated black. DIN 7982, ISO 7050. Dim. 3.5 x 9.5 mm. Type no. 6.</p>	
 <p>192120 Qty. 200 Pozidriv, flat head. Zinc plated black. DIN 7982, ISO 7050. Dim. 3.5 x 13.0 mm. Type no. 6.</p>	 <p>192121 Qty. 200 Pozidriv, flat head. Zinc plated black. DIN 7982, ISO 7050. Dim. 4.2 x 9.5 mm. Type no. 8.</p>	 <p>192122 Qty. 200 Pozidriv, flat head. Zinc plated black. DIN 7982, ISO 7050. Dim. 4.2 x 13.0 mm. Type no. 8.</p>	 <p>192123 Qty. 200 Pozidriv, flat head. Zinc plated black. DIN 7982, ISO 7050. Dim. 4.2 x 16.0 mm. Type no. 8.</p>	

Special Bolts & Screws for Alternators & Starters

804029

 <p>191326 Qty. 200 Flange screw. Steel, el-plated. Spanner size 7. DIN 2621. M4 x 10 mm.</p>	 <p>191327 Qty. 200 Flange screw. Steel, el-plated. Spanner size 7. DIN 2621. M4 x 12 mm.</p>	 <p>191328 Qty. 200 Flange screw. Steel, el-plated. Spanner size 7. DIN 2621. M4 x 14 mm.</p>	 <p>191329 Qty. 100 Flange screw. Steel, el-plated. Spanner size 7. DIN 2621. M6 x 16 mm.</p>	
 <p>191292 Qty. 20 Thru bolt. Pozidriv, cheese head. Partly threaded. Steel, black. M5 x 110 mm. Thread L. 40 mm.</p>	 <p>191330 Qty. 200 Flange screw. Steel, el-plated. Spanner size 7. DIN 2621. M4 x 18 mm.</p>	 <p>191514 Qty. 100 Flange screw. Steel, el-plated. Spanner size 7. DIN 2621. M4 x 28 mm.</p>	 <p>191435 Qty. 50 Pozidriv, flat head. DIN 965, ISO 7046. M5 x 35 mm.</p>	 <p>191266 Qty. 100 Pozidriv, flat head. Steel, el-plated. DIN 7985, ISO 7045. M3 x 5 mm.</p>
 <p>191539 Qty. 20 Thru bolt. Steel, black. M5 x 75 mm. Thread L. 25 mm.</p>	 <p>191528 Qty. 20 Thru bolt. Pozidriv, cheese head. Partly threaded. Steel, black. M5 x 95 mm. Thread L. 30 mm.</p>	 <p>230721 Qty. 10 Repl. 949006-3840. M6 x 70 mm. Thru bolt.</p>	 <p>191486 Qty. 100 Fully threaded. Steel, black. DIN 912, ISO 4762. Quality 12.9. M5 x 14 mm.</p>	 <p>191432 Qty. 100 W/ cuppoint. Steel, black. DIN 916, ISO 4029. M5 x 25 mm.</p>

804028 Special Hex Nuts for Alternators & Starters

 190520 Qty. 200 Steel, el-plated. DIN 934. M3. Spanner size 5.5 mm.	 190521 Qty. 200 Steel, el-plated. DIN 934. M4. Spanner size 7 mm.	 190779 Qty. 200 Steel, el-plated. DIN 934. M5. Spanner size 8 mm.	 190780 Qty. 200 Steel, el-plated. DIN 934. M6. Spanner size 10 mm.	 190782 Qty. 200 Steel, el-plated. DIN 934. M8. Spanner size 8 mm.
 191302 Qty. 200 Counter nut. Steel, el-plated. DIN 439B, ISO 4035. M3. Spanner size 8 mm.	 191303 Qty. 200 Counter nut. Steel, el-plated. DIN 439B, ISO 4035. M6. Spanner size 10 mm.	 191304 Qty. 100 Counter nut. Steel, el-plated. DIN 439B, ISO 4035. M8. Spanner size 13 mm.		
 191306 Qty. 200 Self-locking, flange nut. Steel, el-plated. M4. Spanner size 7 mm.	 191307 Qty. 200 Self-locking, flange nut. Steel, el-plated. M5. Spanner size 8 mm.	 191308 Qty. 200 Self-locking, flange nut. Steel, el-plated. M6. Spanner size 10 mm.	 191513 Qty. 50 Self-locking, flange nut. Steel, el-plated. M8. Spanner size 13 mm.	
 190524 Qty. 200 Self-locking w/ nylon insert. Steel, el-plated. DIN 985-6. M5. Spanner size 8 mm.	 190525 Qty. 200 Self-locking w/ nylon insert. Steel, el-plated. DIN 985-6. M6. Spanner size 10 mm.	 190527 Qty. 200 Self-locking w/ nylon insert. Steel, el-plated. DIN 985-6. M8. Spanner size 13 mm.		

804037 Machine Screws & Nuts

 190520 Qty. 200 Steel, el-plated. DIN 934. M3. Spanner size 5.5 mm.	 190521 Qty. 200 Steel, el-plated. DIN 934. M4. Spanner size 7 mm.	 190779 Qty. 200 Steel, el-plated. DIN 934. M5. Spanner size 8 mm.	 190780 Qty. 200 Steel, el-plated. DIN 934. M6. Spanner size 10 mm.	 190531 Qty. 200 Pozidriv, pan head. Steel, el-plated. DIN 7985, ISO 7045. L. M3 x 10 mm.	 191770 Qty. 200 Pozidriv, pan head. Steel, el-plated. DIN 7985, ISO 7045. L. M4 x 8 mm.
 190536 Qty. 200 Pozidriv, pan head. Steel, el-plated. DIN 7985, ISO 7045. L. M4 x 10 mm.	 191317 Qty. 200 Pozidriv, pan head. Steel, el-plated. DIN 7985, ISO 7045. L. M4 x 14 mm.	 191318 Qty. 200 Pozidriv, pan head. Steel, el-plated. DIN 7985, ISO 7045. L. M4 x 18 mm.	 190540 Qty. 200 Pozidriv, pan head. Steel, el-plated. DIN 7985, ISO 7045. L. M4 x 25 mm.		
 190541 Qty. 200 Pozidriv, pan head. Steel, el-plated. DIN 7985, ISO 7045. L. M4 x 30 mm.	 191319 Qty. 200 Pozidriv, pan head. Steel, el-plated. DIN 7985, ISO 7045. L. M5 x 6 mm.	 190547 Qty. 200 Slotted, cheese head. Steel, el-plated. DIN 84A, ISO 1207. L. M5 x 20 mm.	 190552 Qty. 100 Pozidriv, pan head. Steel, el-plated. DIN 7985, ISO 7045. L. M6 x 10 mm.		
 190544 Qty. 200 Pozidriv, pan head. Steel, el-plated. DIN 7985, ISO 7045. L. M5 x 10 mm.					

Sealing Rings I

804020













 190823 Qty. 20 I.D. 6 mm. O.D. 10 mm. Th. 1 mm. Copper.	 190824 Qty. 20 I.D. 6 mm. O.D. 12 mm. Th. 1 mm. Copper.	 190826 Qty. 20 I.D. 8 mm. O.D. 12 mm. Th. 1 mm. Copper.	 190828 Qty. 20 I.D. 8 mm. O.D. 14 mm. Th. 1 mm. Copper.	 080009 Qty. 20 I.D. 10 mm. O.D. 14 mm. Th. 1 mm. Copper.	 190806 Qty. 20 I.D. 10 mm. O.D. 16 mm. Th. 1 mm. Copper.	 190807 Qty. 20 I.D. 12 mm. O.D. 16 mm. Th. 1.5 mm. Aluminium.	 190808 Qty. 20 I.D. 12 mm. O.D. 16 mm. Th. 1.5 mm. Copper.
 190809 Qty. 20 I.D. 12 mm. O.D. 18 mm. Th. 1.5 mm. Copper.	 191358 Qty. 20 I.D. 12 mm. O.D. 24 mm. Th. 1.5 mm. Copper.		 190810 Qty. 20 I.D. 13 mm. O.D. 18 mm. Th. 1.5 mm. Copper.	 190811 Qty. 20 I.D. 14 mm. O.D. 18 mm. Th. 1.5 mm. Aluminium.	 190812 Qty. 20 I.D. 14 mm. O.D. 18 mm. Th. 1.5 mm. Copper.	 190813 Qty. 20 I.D. 14 mm. O.D. 20 mm. Th. 1.5 mm. Aluminium.	 190815 Qty. 20 I.D. 14 mm. O.D. 20 mm. Th. 1.5 mm. Copper.
 190816 Qty. 20 I.D. 16 mm. O.D. 20 mm. Th. 1 mm. Copper.	 190817 Qty. 20 I.D. 16 mm. O.D. 20 mm. Th. 1 mm. Copper.	 190818 Qty. 20 I.D. 16 mm. O.D. 22 mm. Th. 1 mm. Copper.		 191489 Qty. 20 I.D. 16 mm. O.D. 24 mm. Th. 1.5 mm. Copper.		 190819 Qty. 20 I.D. 18 mm. O.D. 22 mm. Th. 1.5 mm. Copper.	
 190820 Qty. 20 I.D. 18 mm. O.D. 24 mm. Th. 1.5 mm. Copper.		 191490 Qty. 20 I.D. 18 mm. O.D. 26 mm. Th. 1.5 mm. Copper.		 190821 Qty. 20 I.D. 20 mm. O.D. 26 mm. Th. 1.5 mm. Copper.		 190822 Qty. 20 I.D. 22 mm. O.D. 27 mm. Th. 1.5 mm. Copper.	

Insulator Washers (Red fiber)





804019

 191346 Qty. 20 I.D. 4 mm. O.D. 13 mm. Th. 1 mm.	 191341 Qty. 20 I.D. 5 mm. O.D. 10 mm. Th. 1 mm.	 191351 Qty. 20 I.D. 5 mm. O.D. 12 mm. Th. 1 mm.	 191352 Qty. 20 I.D. 5 mm. O.D. 16 mm. Th. 1 mm.	 191344 Qty. 20 I.D. 6 mm. O.D. 10 mm. Th. 1 mm.	 191350 Qty. 20 I.D. 6 mm. O.D. 18 mm. Th. 1.5 mm.	 191442 Qty. 20 I.D. 7.5 mm. O.D. 14 mm. Th. 3 mm.	 191353 Qty. 20 I.D. 8 mm. O.D. 12 mm. Th. 0.5 mm.
 191345 Qty. 20 I.D. 8 mm. O.D. 20 mm. Th. 2 mm.	 191434 Qty. 20 I.D. 10 mm. O.D. 14 mm. Th. 1 mm.	 191349 Qty. 20 I.D. 10 mm. O.D. 16 mm. Th. 1 mm.	 191356 Qty. 20 I.D. 10 mm. O.D. 29 mm. Th. 1 mm.	 191339 Qty. 20 I.D. 12 mm. O.D. 19 mm. Th. 1 mm.	 191348 Qty. 20 I.D. 12.2 mm. O.D. 22 mm. Th. 1 mm.	 191347 Qty. 20 I.D. 13 mm. O.D. 23 mm. Th. 1.5 mm.	
 191430 Qty. 20 I.D. 14.5 mm. O.D. 29 mm. Th. 1 mm.		 191343 Qty. 20 I.D. 14 mm. O.D. 35 mm. Th. 0.5 mm.		 191342 Qty. 20 I.D. 15 mm. O.D. 29 mm. Th. 3 mm.		 191444 Qty. 20 I.D. 17 mm. O.D. 31 mm. Th. 1 mm.	
 191355 Qty. 20 I.D. 20.5 mm. O.D. 35 mm. Th. 1.5 mm.		 191357 Qty. 20 I.D. 23.8 mm. O.D. 36 mm. Th. 2.5 mm.		 191340 Qty. 20 I.D. 29 mm. O.D. 33 mm. Th. 1.5 mm.		 191354 Qty. 20 I.D. 45 mm. O.D. 51 mm. Th. 1 mm.	

804068 Lock Rings

 191277 Qty. 100 Spring steel. DIN 6799. For shaft O.D. M3.2 mm.	 191278 Qty. 100 Spring steel. DIN 6799. For shaft O.D. M6 mm.	 191573 Qty. 100 Spring steel. DIN 6799. For shaft O.D. M7 mm.	 191279 Qty. 100 Spring steel. DIN 6799. For shaft O.D. M8 mm.	 191280 Qty. 100 Spring steel. DIN 6799. For shaft O.D. M9 mm.	 191270 Qty. 100 Spring steel. DIN 471. For shaft O.D. M15 mm.	 191271 Qty. 100 Spring steel. DIN 471. For shaft O.D. M18 mm.
 191333 Qty. 100 Spring steel. DIN 471. For shaft O.D. M19 mm.	 191272 Qty. 100 Spring steel. DIN 471. For shaft O.D. M20 mm.	 191273 Qty. 100 Spring steel. DIN 471. For shaft O.D. M21 mm.	 191274 Qty. 100 Spring steel. DIN 471. For shaft O.D. M22 mm.			
 191481 Qty. 100 Spring steel. DIN 471. For shaft O.D. M23 mm.	 191275 Qty. 100 Spring steel. DIN 471. For shaft O.D. M24 mm.	 191276 Qty. 100 Spring steel. DIN 471. For shaft O.D. M25 mm.	 191433 Qty. 100 Spring steel. DIN 471. For shaft O.D. M27 mm.			

804065 Protecting Caps

Threaded, Colour: Red, Polyethylen (PE)			
 191862 Qty. 100 M 8.0-1.0. H. 10.0 mm.	 191863 Qty. 100 M 10.0-1.0. H. 10.0 mm.	 191864 Qty. 100 M 12.0-1.0. H. 12.0 mm.	
 191865 Qty. 100 M 12.0-1.5. H. 12.0 mm.		 191866 Qty. 100 M 14.0-1.5. H. 12.0 mm. Colour: Yellow.	

Protecting Plugs

804064

Threaded, Colour: Red, Polyethylen (PE)



191857 Qty. 100
M8.0-1.0.



191858 Qty. 100
M10.0-1.0.



191859 Qty. 100
M12.0-1.0.



191860 Qty. 100
M12.0-1.5.



191861 Qty. 100
M14.0-1.5.

PVC Caps

804041



191364 Qty. 100
O.D. 4.8/5.5 con.
I.D. 3.2/4.0 con.
H. 6.5 mm.



191365 Qty. 100
O.D. 6.0/6.7 con.
I.D. 4.5/5.3 con.
H. 6.7 mm.



191366 Qty. 100
O.D. 6.4/7.4 con.
I.D. 4.9/5.9 con.
H. 7.8 mm.



191367 Qty. 100
O.D. 7.6/8.5 con.
I.D. 6.0/7.1 con.
H. 8.8 mm.



191368 Qty. 100
O.D. 8.2/9.2 con.
I.D. 6.6/7.8 con.
H. 10.0 mm.



191369 Qty. 50
O.D. 9.8/11.0 con.
I.D. 8.1/9.5 con.
H. 10.9 mm.



191370 Qty. 50
O.D. 10.8/12.3 con.
I.D. 9.0/10.6 con.
H. 10.4 mm.



191371 Qty. 50
O.D. 11.4/12.7 con.
I.D. 9.9/11.3 con.
H. 10.8 mm.



191372 Qty. 30
O.D. 13.1/14.5 con.
I.D. 11.5/13.5 con.
H. 12.0 mm.



191373 Qty. 30
O.D. 13.9/15.4 con.
I.D. 12.7/14.7 con.
H. 13.6 mm.



191375 Qty. 50
O.D. 15.2/16.9 con.
I.D. 13.9/15.7 con.
H. 13.9 mm.

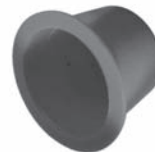

191480 Qty. 40
O.D. 17.2/19.0 con.
I.D. 15.5/17.2 con.
H. 14.7 mm.

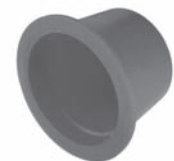









191376 Qty. 40
O.D. 18.3/19.9 con.
I.D. 16.3/19.0 con.
H. 14.8 mm.



191374 Qty. 30
O.D. 14.2/15.7 con.
I.D. 12.7/14.7 con.
H. 13.6 mm.





















804088 Button & High Voltage Batteries

 <p>200773 Qty. 5 3.0 V. Dim.: 12.5 x 2.0 mm. Type CR 1220. Lithium battery.</p>	 <p>200802 Qty. 5 3.0 V. Dim.: 16 x 2.0 mm. Type CR 1620. Lithium battery.</p>	 <p>200774 Qty. 5 3.0 V. Dim.: 20.0 x 2.5 mm. Type CR 2025. Lithium battery.</p>	 <p>200775 Qty. 5 3.0 V. Dim.: 20.0 x 3.2 mm. Type CR 2032. Lithium battery.</p>
 <p>200772 Qty. 5 3.0 V. Dim.: 10.0 x 1.6 mm. Type CR 2016. Lithium battery.</p>	 <p>200778 Qty. 5 1.5 V. Dim.: 15.6 x 5.95 mm. Type LR 9. Alkaline battery.</p>	 <p>200779 Qty. 5 1.55 V. Dim.: 11.6 x 5.4 mm. Type SR 44. Silver oxide battery.</p>	 <p>200792 Qty. 5 1.5 V. Dim.: 11.7 x 29.1 mm. Type LT1. Alkaline battery.</p>
 <p>200776 Qty. 5 6.0 V. Dim.: 10.0 x 16.0 mm. Type MN 11. Alkaline battery.</p>		 <p>200791 Qty. 5 6.0 V. Dim.: 13.0 x 25.2 mm. Type 4LR44. Alkaline battery.</p>	
 <p>200777 Qty. 5 12 V. Dim.: 7.7 x 28 mm. Type MN 27. Alkaline battery.</p>		 <p>200743 Qty. 5 12 V. Dim.: 10.0 x 28 mm. Type GA23/MN21. Alkaline battery.</p>	

804072 Bits

 <p>210708 Qty. 2 5.5 x 1.0 mm. L. 39 mm. 1/4" Slotted bits.</p>	 <p>210709 Qty. 2 8 x 1.2 mm. L. 39 mm. 1/4" Slotted bits.</p>	 <p>210710 Qty. 2 8 x 1.6 mm. L. 39 mm. 1/4" Slotted bits.</p>	 <p>210741 Qty. 2 12.0 x 2.0 mm. L. 41 mm. 5/16" Slotted bits.</p>	 <p>210750 Qty. 2 Type 1. L. 50 mm. 1/4" PH bits.</p>	 <p>210759 Qty. 2 Type 2. L. 25 mm. 1/4" PH bits.</p>	 <p>210712 Qty. 2 Type 3. L. 25 mm. 1/4" PH bits.</p>	 <p>210751 Qty. 2 Type 3. L. 50 mm. 1/4" PH bits.</p>
 <p>210713 Qty. 2 Type 4. L. 32 mm. 1/4" PH bits.</p>	 <p>210742 Qty. 2 Type 2. L. 32 mm. 5/16" PH bits.</p>	 <p>210743 Qty. 2 Type 3. L. 32 mm. 5/16" PH bits.</p>	 <p>210744 Qty. 2 Type 4. L. 38 mm. 5/16" PH bits.</p>	 <p>210740 Qty. 2 Type 2. L. 50 mm. 1/4" Pz bits.</p>	 <p>210715 Qty. 2 Type 3. L. 25 mm. 1/4" Pz bits.</p>	 <p>210716 Qty. 2 Type 4. L. 32 mm. 1/4" Pz bits.</p>	 <p>210718 Qty. 2 Type T06. L. 25 mm. 1/4" Torx bits.</p>
 <p>210720 Qty. 2 Type T08. L. 25 mm. 1/4" Torx bits.</p>	 <p>210722 Qty. 2 Type T10. L. 25 mm. 1/4" Torx bits.</p>	 <p>210723 Qty. 2 Type T15. L. 25 mm. 1/4" Torx bits.</p>	 <p>210724 Qty. 2 Type T20. L. 25 mm. 1/4" Torx bits.</p>	 <p>210725 Qty. 2 Type T25. L. 25 mm. 1/4" Torx bits.</p>	 <p>210726 Qty. 2 Type T27. L. 25 mm. 1/4" Torx bits.</p>	 <p>210727 Qty. 2 Type T30. L. 25 mm. 1/4" Torx bits.</p>	 <p>210729 Qty. 2 Type T40. L. 25 mm. 1/4" Torx bits W boring.</p>
 <p>210745 Qty. 2 Type T25. L. 35 mm. 5/16" Torx bits.</p>	 <p>210747 Qty. 2 Type T45. L. 35 mm. 5/16" Torx bits.</p>	 <p>210748 Qty. 2 Type T50. L. 35 mm. 5/16" Torx bits.</p>	 <p>210752 Qty. 2 Type 3. L. 50 mm. 1/4" hex bits.</p>	 <p>210753 Qty. 2 Type 4. L. 50 mm. 1/4" hex bits.</p>	 <p>210754 Qty. 2 Type 5. L. 50 mm. 1/4" hex bits.</p>	 <p>210757 Qty. 1 Bitholder magnetic. L. 74 mm.</p>	

HSS Drills **210574**

 210141 Qty. 10 Din 338 type N. O.D. 1.0 mm.	 210143 Qty. 10 Din 338 type N. O.D. 2.0 mm.	 210145 Qty. 20 Din 338 type N. O.D. 3.0 mm.	 210147 Qty. 10 Din 338 type N. O.D. 4.0 mm.	 210149 Qty. 10 Din 338 type N. O.D. 5.0 mm.	 210151 Qty. 10 Din 338 type N. O.D. 5.0 mm.	 210153 Qty. 5 Din 338 type N. O.D. 7.0 mm.	 210155 Qty. 5 Din 338 type N. O.D. 8.0 mm.	 210157 Qty. 3 Din 338 type N. O.D. 9.0 mm.	 210159 Qty. 3 Din 338 type N. O.D. 10.0 mm.	 210160 Qty. 3 Din 338 type N. O.D. 10.5 mm.
 210158 Qty. 3 Din 338 type N. O.D. 9.5 mm.	 210156 Qty. 3 Din 338 type N. O.D. 8.5 mm.	 210154 Qty. 3 Din 338 type N. O.D. 7.5 mm.	 210152 Qty. 10 Din 338 type N. O.D. 6.5 mm.	 210150 Qty. 10 Din 338 type N. O.D. 5.5 mm.	 210148 Qty. 10 Din 338 type N. O.D. 4.5 mm.	 210164 Qty. 10 Din 338 type N. O.D. 3.5 mm.	 210146 Qty. 10 Din 338 type N. O.D. 3.3 mm.	 210144 Qty. 10 Din 338 type N. O.D. 2.5 mm.	 210142 Qty. 10 Din 338 type N. O.D. 1.5 mm.	















ASSORTMENTS

PART 6

Notes

A large, empty rectangular box with rounded corners, intended for writing notes. The box is currently blank.

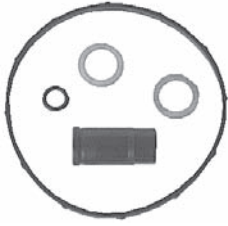
806003 Throttle Shafts Repl. BOSCH I

<p>080136 Qty. 1 Repl. 1463 161 644. Serv. Volvo. VE Throttle shaft.</p> 	<p>080139 Qty. 1 Repl. 1463 161 725. Serv. Ford, VW, Fiat. VE Throttle shaft.</p> 	<p>080140 Qty. 1 Repl. 1463 161 390. Serv. Fiat, VW. VE Throttle shaft.</p> 	<p>080141 Qty. 1 Repl. 1463 161 377. Serv. Fiat, VW, Renault, Simca. VE Throttle shaft.</p> 
<p>080142 Qty. 1 Repl. 1463 161 581. Serv. Fiat. VE Throttle shaft.</p> 	<p>080143 Qty. 1 Repl. 1463 161 379. Serv. Opel, Audi, Volvo. VE Throttle shaft.</p> 	<p>080144 Qty. 1 Repl. 1463 161 381, -448. Serv. Ford, Fiat, Opel, Peugeot. VE Throttle shaft.</p> 	<p>080145 Qty. 1 Repl. 1463 161 383. Serv. Renault, Volvo. VE Throttle shaft.</p> 
<p>080146 Qty. 1 Repl. 1463 161 523. Serv. Audi, Renault. VE Throttle shaft.</p> 			
<p>080154 Qty. 1 Repl. 1463 161 597. Serv. VW, Fiat, Lancia. VE Throttle shaft.</p> 	<p>080166 Qty. 1 Serv. Bosch. L. 20 mm. W/ O-ring and gasket. Bushing 080161.</p>	<p>080169 Qty. 1 Serv. Bosch. L. 35 mm. W/ O-ring and gasket. Bushing 080164.</p>	<p>080170 Qty. 1 Serv. Bosch. L. 30.5 mm. W/ O-ring and gasket. Bushing 080165.</p>

806029 Throttle Shafts Repl. BOSCH II

<p>080161 Qty. 5 Repl. 1460 324 315. L. 20 mm. Bushing for cover.</p> 	<p>080162 Qty. 3 Repl. 1460 324 316. L. 25 mm. Bushing for cover.</p> 	<p>080165 Qty. 5 Repl. 1460 324 333. L. 30.5 mm. Bushing for cover.</p> 	<p>080232 Qty. 3 Repl. 1460 324 337. L. 33.5 mm. Bushing for cover.</p> 
<p>080164 Qty. 5 Repl. 1460 324 332. L. 35 mm. Bushing for cover.</p> 	<p>080163 Qty. 5 Repl. 1460 324 331. L. 40.5 mm. Bushing for cover.</p> 	<p>080123 Qty. 1 Repl. 1463 161 366. Serv. Ford. A: 43.3, B: 6.0, C: 19.5, D: 37.5, E: 20.2 mm.</p> 	<p>080141 Qty. 1 Repl. 1463 161 337. Serv. Fiat, Renault, Simca, VW. A: 38.8, B: 6.5, C: 15.0, D: 60.6 mm.</p> 
<p>080755 Qty. 1 Repl. 1463 161 596. A: 50.0, B: 6.5, C: 29.7, D: 37.3, E: 20.5 mm.</p> 	<p>080828 Qty. 1 Repl. 1463 162 104. Serv. Opel, Ford, VW. A: 47.2, B: 3.0, C: 26.7, D: 59.5 mm.</p> 	<p>081112 Qty. 1 Repl. 1463 161 875. Serv. Peugeot, Renault, VW. A: 56.1, B: 2.9, C: 26.5, D: 60.5 mm.</p> 	<p>080420 Qty. 20 Repl. 1460 210 008. O-ring for throttle shafts 6.5 / 10.5 x 2 mm.</p> 
<p>080098 Qty. 10 Repl. 1460 206 303. Cover gasket.</p> 	<p>080099 Qty. 10 Repl. 1460 015 300. Serv. VE. Vover gasket.</p> 	<p>080972 Qty. 10 Repl. 096446-0100. Serv. Bosch, Nippondenso, Zexel. VE cover gasket.</p> 	<p>080009 Qty. 100 Repl. 726381. Serv. Iveco. 14 / 10 x 1 mm. Copper.</p> 















Solenoid Stops

806024

 <p>080177 Qty. 2 Repl. 0330 001 015, -018. 12 V.</p>	 <p>080178 Qty. 1 Repl. 0330 001 016. 24 V.</p>	 <p>080207 Qty. 2 Repl. 9009-041, -049, -073. 12 V.</p>	 <p>080209 Qty. 1 Repl. 9145-040D. 12 V.</p>
 <p>080210 Qty. 2 Repl. 7180-49C, -49D. 24 V.</p>	 <p>080212 Qty. 1 Repl. 7167-620C, -620D. 12 V.</p>	 <p>080595 Qty. 1 Repl. 7167-620A, -620B. 12 V.</p>	

Throttle Shafts & Cover Gaskets Repl. CAV



















806008

 <p>080186 Qty. 2 Repl. 9100-178. Serv. DPC.</p>	 <p>080189 Qty. 2 Repl. 7123-770D. Serv. DPA.</p>	 <p>080187 Qty. 2 Repl. 7174-828E. Serv. DPS.</p>	 <p>080188 Qty. 2 Repl. 7173-770. Serv. DPA. Short type.</p>	 <p>080190 Qty. 2 Repl. 7123-770E. Serv. DPA.</p>
 <p>080191 Qty. 2 Repl. 7123-770A. Serv. DPA. Long type.</p>	 <p>080192 Qty. 2 Repl. 7139-791A, C. Serv. DPA.</p>	 <p>080193 Qty. 2 Repl. 7139-791, D. Serv. DPA.</p>	 <p>080753 Qty. 5 Serv. DPC. Bushing.</p>	 <p>080194 Qty. 20 Repl. 5855-30. 6.0 / 9.6 x 1.8 mm. O-ring.</p>
 <p>080738 Qty. 5 Repl. 9007-497L. Serv. DPC. Cover-gasket.</p>	 <p>080204 Qty. 5 Repl. 7174-491. Serv. DPS. Cover-gasket.</p>	 <p>080205 Qty. 5 Repl. 7123-287, 7180-451. Serv. DPA. Cover-gasket.</p>	 <p>080932 Qty. 5 Repl. 7174-274A. Serv. DPS. Cover-gasket.</p>	

806014 Throttle Shafts - Japanese Applications

 <p>080099 Qty. 1 Repl. 1460 015 300, 1461 015 300. Serv. VE. Cover gasket.</p>	 <p>080220 Qty. 1 Repl. 096450-0170. Serv. VE. Toyota.</p>	 <p>080221 Qty. 1 Repl. 096450-0180. Serv. VE. Toyota Hi-Ace.</p>	 <p>080222 Qty. 1 Repl. 096460-0132. Serv. VE. Toyota Camry.</p>
 <p>080223 Qty. 1 Repl. 096460-0141. Serv. VE. Toyota Camry Turbo.</p>	 <p>080215 Qty. 1 Repl. 146513-2020, 9461-613 632. Serv. VE. Nissan.</p>	 <p>080218 Qty. 1 Repl. 146510-1720, 9461 610 261. Serv. VE. Mitsubishi Shogun.</p>	 <p>080420 Qty. 10 Repl. 1460 210 008. O-ring for throttle shafts 6.5 / 10.5 x 2 mm.</p>

806012 Nozzle holder Parts

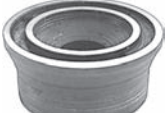
 <p>080331 Qty. 2 Repl. 2433 124 161. Serv. KCA. Pin for nozzle holder.</p>	 <p>080332 Qty. 2 Repl. 2433 124 013, 162. Serv. KCA. Pin for nozzle holder.</p>	 <p>080333 Qty. 2 Repl. 2433 120 112. Serv. KBEL, KDEL. Pin for nozzle holder.</p>	 <p>080334 Qty. 2 Repl. 2433 124 035. Pin for nozzle holder.</p>	 <p>080335 Qty. 2 Repl. 2433 124 038. Serv. KBAL. Pin for nozzle holder.</p>	 <p>080336 Qty. 2 Repl. 2433 124 007. Serv. KBEL, KDEL. Pin for nozzle holder.</p>	 <p>080337 Qty. 2 Repl. 2433 124 294. Serv. KBAL. Pin for nozzle holder.</p>	
 <p>080338 Qty. 2 Repl. 2430 136 078, -166. Serv. KBEL, KDEL. Injector spacer.</p>	 <p>080339 Qty. 2 Repl. 2430 136 031. Serv. KBA, KCA, KDA. Injector spacer.</p>	 <p>080340 Qty. 2 Repl. 2430 136 015, -202. Serv. KBAL, KDAL. Injector spacer.</p>	 <p>080341 Qty. 2 Repl. 2430 136 105. Serv. KCA. Injector spacer.</p>	 <p>080342 Qty. 2 Repl. 2430 136 145. Serv. KCA. Injector spacer.</p>	 <p>080343 Qty. 2 Repl. 2430 136 085. Serv. KBEL, KDEL. Injector spacer.</p>	 <p>080344 Qty. 2 Repl. 2430 136 017, 191. Serv. KDAL. Injector spacer.</p>	 <p>080345 Qty. 2 Repl. 2430 136 079, -167. Serv. KBE. Injector spacer.</p>
 <p>080346 Qty. 2 Repl. 2430 136 159. Injector spacer.</p>	 <p>080348 Qty. 2 Repl. 2430 136 171. Injector spacer.</p>	 <p>080347 Qty. 2 Repl. 7169-408. Injector spacer.</p>	 <p>080353 Qty. 2 Repl. 150524-0600. Injector spacer.</p>				

Flame Arresters - European Applications

806009

 080039 Qty. 6 Repl. 1410 501 070. 23.56 / 5.5 x 3.55 mm. Steel.	 080231 Qty. 6 Repl. 1167 601 455. 21 / 5.4 x 12.9 mm. Steel.	 080385 Qty. 6 Repl. 1410 501 074. 24.6 / 2.25 x 3.8 mm. Steel.	 080386 Qty. 6 Repl. 1410 501 075. 23.85 / 8.25 x 3.45 mm. Steel.	 080388 Qty. 6 Repl. 9431 610 360. 13.60 / 7.3 x 1.3 mm. Steel.	 080390 Qty. 6 Repl. 1410 501 072. 20.15 / 5.5 x 3.5 mm. Steel.	 080392 Qty. 6 Repl. 617 017 01 06. 20.2 / 7.5 x 2.45 mm. Steel.	 080393 Qty. 6 Repl. 4.279.493. 20.15 / 5.5 x 13 mm. Steel.
 080394 Qty. 6 Repl. 821701. 21.5 / 7.35 x 14.55 mm. Steel.	 080395 Qty. 6 Repl. 571.099. 21.0 / 5.5 x 9.55 mm. Steel.	 080397 Qty. 6 Repl. 2430 501 006. 20.0 / 7.7 x 2.7 mm. Copper.	 080398 Qty. 6 13.8 / 7.3 x 1.4 mm. Steel.	 080400 Qty. 6 19.0 / 9.0 x 7.5 mm. Copper.	 080402 Qty. 6 17.5 / 11.0 x 5.4 mm. Copper.	 080405 Qty. 6 13.8 / 7.1 x 1.3 mm. Brass.	 080407 Qty. 6 13.9 / 6.4 x 1.7 mm. Steel.
 080408 Qty. 6 13.9 / 5.2 x 1.1 mm. Steel.	 080409 Qty. 6 Repl. 9432 361 400. 21.5 / 7.35 x 13.4 mm. Steel.	 080413 Qty. 6 21.6 / 7.3 x 14.5 mm. Steel.	 080421 Qty. 6 Repl. 821627. 17.25 / 6.3 x 4.5 mm. Steel.	 080732 Qty. 6 Repl. 2430 501 004. 20 / 10.1 x 2.6 mm. Steel.			
 080736 Qty. 6 Repl. 601 017 0060. 20.0 / 7.9 x 2.85 mm. Steel zinc plated.		 080748 Qty. 6 Repl. 7700690543. 21.45 / 5.4 x 15 mm. Steel.					

Flame Arresters & Thermal Washers - Japanese Applications

806010

 080677 Qty. 6 Repl. 11176-8730. 21.5 / 7 x 3.95 mm. Brass.	 080413 Qty. 6 21.7 / 7.5 x 3.9 mm. Brass.	 080403 Qty. 6 15 / 7 x 6.7 mm. Copper.	 080404 Qty. 6 11.5 / 4.9 x 1.25 mm. Steel.	 080410 Qty. 6 14 / 7.3 x 4.8 mm. Copper.	 080401 Qty. 6 18 / 10.7 x 4.4 mm. Copper.	 080423 Qty. 6 20.3 / 7.6 x 2.5 mm. Steel.
 080400 Qty. 6 19 / 9 x 7.5 mm. Copper.	 080402 Qty. 6 17.5 / 11 x 5.4 mm. Copper.	 080406 Qty. 6 14.3 / 8.5 x 1.1 mm. Brass.	 080411 Qty. 6 16 / 10 x 4 mm. Copper.			
 080412 Qty. 6 14 / 7.3 x 4 mm. Copper.	 080236 Qty. 6 Repl. 11178-56010. 13.4 / 7.1 x 1.1 mm. Brass.	 080414 Qty. 6 Repl. 11176-36010. 20 / 15 x 2.8 mm. Brass.	 080415 Qty. 6 Repl. 11176-56010, 56018. 20.5 / 15.5 x 2.8 mm. Brass.			
 080416 Qty. 6 Repl. 11177-54011. 14 / 10 x 1.6 mm. Steel.	 080417 Qty. 6 Repl. 11177-64010, MD 070718. 10.8 / 7.8 x 1.5 mm. Copper.	 080418 Qty. 6 Repl. 11176-64010. 18 / 12.6 x 2.5 mm. Brass.	 080419 Qty. 6 Repl. 11177-56010. 14 / 8.8 x 1.3 mm. Brass.			





















806011 Thermal Washers

 080425 Qty. 10 O.D. 15.0 mm. I.D. 7.5 mm. Th. 2.0 mm. Copper.	 080426 Qty. 10 O.D. 15.0 mm. I.D. 8.0 mm. Th. 1.0 mm. Copper.	 080427 Qty. 10 Repl. 2430 105 046 mm. Serv. Ford. 15 / 8 x 2 mm. Copper.	 080428 Qty. 10 O.D. 15.0 mm. I.D. 10.0 mm. Th. 2.0 mm. Copper.	 080429 Qty. 10 O.D. 15.7 mm. I.D. 7.5 mm. Th. 1.5 mm. Copper.	 080432 Qty. 10 O.D. 18.0 mm. I.D. 0.0 mm. Th. 1.0 mm. Copper.	 080433 Qty. 10 O.D. 18.0 mm. I.D. 10.0 mm. Th. 1.5 mm. Copper.	 080434 Qty. 10 O.D. 18.0 mm. I.D. 12.0 mm. Th. 2.0 mm. Copper.
 080436 Qty. 10 O.D. 19.0 mm. I.D. 10.0 mm. Th. 2.0 mm. Copper.	 080439 Qty. 10 O.D. 20.0 mm. I.D. 7.2 mm. Th. 1.5 mm. Copper.	 080440 Qty. 10 O.D. 20.0 mm. I.D. 10.0 mm. Th. 0.5 mm. Copper.	 080441 Qty. 10 O.D. 20.0 mm. I.D. 10.0 mm. Th. 1.0 mm. Copper.	 080442 Qty. 10 O.D. 20.0 mm. I.D. 10.0 mm. Th. 1.5 mm. Copper.	 080444 Qty. 10 O.D. 20.0 mm. I.D. 14.0 mm. Th. 1.8 mm. Copper.	 080446 Qty. 10 O.D. 20.0 mm. I.D. 14.3 mm. Th. 2.0 mm. Copper.	 080447 Qty. 10 O.D. 20.0 mm. I.D. 14.0 mm. Th. 2.0 mm. Copper.
 080448 Qty. 10 O.D. 20.0 mm. I.D. 15.3 mm. Th. 2.0 mm. Copper.	 080430 Qty. 10 O.D. 21.0 mm. I.D. 14.5 x 1.5 mm. Th. 2.0 mm. Copper.	 080450 Qty. 10 O.D. 21.5 mm. I.D. 17.5 mm. Th. 1.5 mm. Copper.	 080296 Qty. 10 O.D. 20.5 mm. I.D. 10.0 mm. Th. 2.0 mm. Copper.	 080424 Qty. 10 O.D. 17.5 mm. I.D. 10.8 mm. Th. 1.7 mm. Copper.	 080431 Qty. 10 O.D. 16.3 mm. I.D. 10.0 mm. Th. 1.5 mm. Copper.	 080435 Qty. 10 O.D. 18.0 mm. I.D. 15.0 mm. Th. 0.5 mm. Copper.	 080437 Qty. 10 O.D. 19.0 mm. I.D. 10.0 mm. Th. 0.3 mm. Aluminium.
 080438 Qty. 10 O.D. 19.0 mm. I.D. 10.0 mm. Th. 0.3 mm. Conical. Copper.	 080443 Qty. 10 O.D. 20.0 mm. I.D. 10.0 mm. Th. 2.0 mm. Copper.	 080449 Qty. 10 O.D. 20.5 mm. I.D. 9.3 mm. Th. 2.6 mm. Steel / Asbestos.	 080456 Qty. 10 O.D. 14.5 mm. I.D. 6.8 mm. Th. 1.0 mm. Copper.	 080452 Qty. 10 O.D. 22.0 mm. I.D. 10.0 mm. Th. 0.7 mm. Copper.	 080453 Qty. 10 O.D. 22.0 mm. I.D. 10.0 mm. Th. 1.0 mm. Copper.	 080454 Qty. 10 O.D. 22.5 mm. I.D. 9.5 mm. Th. 0.5 mm. Copper.	 080688 Qty. 10 O.D. 22.5 mm. I.D. 14.5 mm. Th. 1.4 mm. Copper.

























806004 Adjustment Shims

 080507 Qty. 10 Th. 1.00 mm.	 080508 Qty. 10 Th. 1.05 mm.	O.D. 6.8 mm. I.D. 3.2 mm.				 080513 Qty. 10 Th. 1.30 mm.	 080514 Qty. 10 Th. 1.35 mm.
 080515 Qty. 10 Th. 1.40 mm.	 080516 Qty. 10 Th. 1.45 mm.	 080509 Qty. 10 Th. 1.10 mm.	 080510 Qty. 10 Th. 1.15 mm.	 080511 Qty. 10 Th. 1.20 mm.	 080512 Qty. 10 Th. 1.25 mm.	 080517 Qty. 10 Th. 1.50 mm.	 080518 Qty. 10 Th. 1.55 mm.
 080520 Qty. 10 Th. 1.65 mm.	 080521 Qty. 10 Th. 1.70 mm.	 080519 Qty. 10 Th. 1.60 mm.	 080522 Qty. 10 Th. 1.75 mm.	 080523 Qty. 10 Th. 1.80 mm.	 080524 Qty. 10 Th. 1.85 mm.	 080525 Qty. 10 Th. 1.90 mm.	 080526 Qty. 10 Th. 1.95 mm.

























Adjustment Shims **806005**

		O.D. 7.25 mm. I.D. 3.0 mm.					
 080486 Qty. 10 Th. 1.00 mm.	 080487 Qty. 10 Th. 1.05 mm.	 080488 Qty. 10 Th. 1.10 mm.	 080489 Qty. 10 Th. 1.15 mm.	 080490 Qty. 10 Th. 1.20 mm.	 080491 Qty. 10 Th. 1.25 mm.	 080492 Qty. 10 Th. 1.30 mm.	 080493 Qty. 10 Th. 1.35 mm.
 080494 Qty. 10 Th. 1.40 mm.	 080495 Qty. 10 Th. 1.45 mm.	 080496 Qty. 10 Th. 1.50 mm.		 080497 Qty. 10 Th. 1.55 mm.		 080498 Qty. 10 Th. 1.60 mm.	
 080499 Qty. 10 Th. 1.65 mm.		 080500 Qty. 10 Th. 1.70 mm.		 080501 Qty. 10 Th. 1.75 mm.		 080502 Qty. 10 Th. 1.80 mm.	
 080503 Qty. 10 Th. 1.85 mm.		 080504 Qty. 10 Th. 1.90 mm.		 080505 Qty. 10 Th. 1.95 mm.		 080506 Qty. 10 Th. 1.85 mm.	























Adjustment Shims Servicing BOSCH **806025**

		O.D. 8.5 mm. I.D. 3.0 mm.					
 080876 Qty. 10 Th. 0.80 mm.	 080877 Qty. 10 Th. 0.85 mm.	 080878 Qty. 10 Th. 0.90 mm.	 080879 Qty. 10 Th. 0.95 mm.	 080880 Qty. 10 Th. 1.00 mm.	 080881 Qty. 10 Th. 1.05 mm.	 080882 Qty. 10 Th. 1.10 mm.	 080883 Qty. 10 Th. 1.15 mm.
 080884 Qty. 10 Th. 1.20 mm.	 080885 Qty. 10 Th. 1.25 mm.	 080886 Qty. 10 Th. 1.30 mm.	 080887 Qty. 10 Th. 1.35 mm.	 080888 Qty. 10 Th. 1.40 mm.	 080889 Qty. 10 Th. 1.45 mm.	 080890 Qty. 10 Th. 1.50 mm.	 080891 Qty. 10 Th. 1.55 mm.
 080892 Qty. 10 Th. 1.60 mm.	 080893 Qty. 10 Th. 1.65 mm.	 080894 Qty. 10 Th. 1.70 mm.	 080895 Qty. 10 Th. 1.75 mm.	 080896 Qty. 10 Th. 1.80 mm.	 080897 Qty. 10 Th. 1.85 mm.	 080898 Qty. 10 Th. 1.90 mm.	 080899 Qty. 10 Th. 1.95 mm.
 080900 Qty. 10 Th. 2.00 mm.							

806026 Adjustment Shims Servicing CAV

		O.D. 9.4 mm. I.D. 4.0 mm.					
 080901 Qty. 10 Th. 0.80 mm.	 080902 Qty. 10 Th. 0.85 mm.	 080903 Qty. 10 Th. 0.90 mm.	 080904 Qty. 10 Th. 0.95 mm.	 080905 Qty. 10 Th. 1.00 mm.	 080906 Qty. 10 Th. 1.05 mm.	 080907 Qty. 10 Th. 1.10 mm.	 080908 Qty. 10 Th. 1.15 mm.
 080909 Qty. 10 Th. 1.20 mm.	 080910 Qty. 10 Th. 1.25 mm.	 080911 Qty. 10 Th. 1.30 mm.	 080912 Qty. 10 Th. 1.35 mm.	 080913 Qty. 10 Th. 1.40 mm.	 080914 Qty. 10 Th. 1.45 mm.	 080915 Qty. 10 Th. 1.50 mm.	 080916 Qty. 10 Th. 1.55 mm.
 080917 Qty. 10 Th. 1.60 mm.	 080918 Qty. 10 Th. 1.65 mm.	 080919 Qty. 10 Th. 1.70 mm.	 080920 Qty. 10 Th. 1.75 mm.	 080921 Qty. 10 Th. 1.80 mm.	 080922 Qty. 10 Th. 1.85 mm.	 080923 Qty. 10 Th. 1.90 mm.	 080924 Qty. 10 Th. 1.95 mm.
 080925 Qty. 10 Th. 2.00 mm.							

806006 Adjustment Shims

		O.D. 9.8 mm. I.D. 3.2 mm.					
 080325 Qty. 10 Th. 0.05 mm.	 080326 Qty. 10 Th. 0.10 mm.	 080327 Qty. 10 Th. 1.00 mm.	 080328 Qty. 10 Th. 1.05 mm.	 080329 Qty. 10 Th. 1.10 mm.	 080468 Qty. 10 Th. 1.15 mm.	 080469 Qty. 10 Th. 1.20 mm.	 080470 Qty. 10 Th. 1.25 mm.
 080471 Qty. 10 Th. 1.30 mm.	 080472 Qty. 10 Th. 1.35 mm.	 080473 Qty. 10 Th. 1.40 mm.	 080474 Qty. 10 Th. 1.45 mm.	 080475 Qty. 10 Th. 1.50 mm.	 080476 Qty. 10 Th. 1.55 mm.	 080477 Qty. 10 Th. 1.60 mm.	
 080478 Qty. 10 Th. 1.65 mm.		 080479 Qty. 10 Th. 1.70 mm.		 080480 Qty. 10 Th. 1.75 mm.		 080481 Qty. 10 Th. 1.80 mm.	
 080482 Qty. 10 Th. 1.85 mm.		 080483 Qty. 10 Th. 1.90 mm.		 080484 Qty. 10 Th. 1.95 mm.		 080485 Qty. 10 Th. 2.00 mm.	

O.E.M. names and numbers are used for reference purposes only.

Adjustment Shims **806007**

		O.D. 11.5 mm. I.D. 5.0 mm.					
080299 Qty. 10 Th. 0.10 mm.	080300 Qty. 10 Th. 0.20 mm.	080301 Qty. 10 Th. 0.80 mm.	080302 Qty. 10 Th. 0.85 mm.	080303 Qty. 10 Th. 0.90 mm.	080304 Qty. 10 Th. 1.00 mm.	080305 Qty. 10 Th. 1.05 mm.	080306 Qty. 10 Th. 1.10 mm.
080307 Qty. 10 Th. 1.15 mm.	080308 Qty. 10 Th. 1.20 mm.	080309 Qty. 10 Th. 1.25 mm.	080310 Qty. 10 Th. 1.30 mm.	080311 Qty. 10 Th. 1.35 mm.	080312 Qty. 10 Th. 1.40 mm.	080313 Qty. 10 Th. 1.45 mm.	080314 Qty. 10 Th. 1.50 mm.
080315 Qty. 10 Th. 1.55 mm.	080316 Qty. 10 Th. 1.60 mm.	080317 Qty. 10 Th. 1.65 mm.	080318 Qty. 10 Th. 1.70 mm.	080319 Qty. 10 Th. 1.75 mm.	080320 Qty. 10 Th. 1.80 mm.	080321 Qty. 10 Th. 1.85 mm.	080322 Qty. 10 Th. 1.90 mm.
080323 Qty. 10 Th. 1.95 mm.	080324 Qty. 10 Th. 2.00 mm.						















Hollow Screws & Sealing Rings **806016**

080251 Qty. 10 Thread M8-1.0 mm. Bore 2.3 mm.	080252 Qty. 10 Thread M10-1.0 mm. Bore 4.0 mm.	080253 Qty. 10 Thread M10-1.5 mm. Bore 4.0 mm.	080254 Qty. 10 Thread M12-1.5 mm. Bore 6.0 mm.			
080255 Qty. 10 Thread M14-1.5 mm. Bore 8.0 mm.	080256 Qty. 5 Thread M16-1.5 mm. Bore 10.0 mm.	080257 Qty. 10 Thread M8-1.0 mm. Bore 2.0 mm. Double.	080258 Qty. 5 Thread M14-1.5 mm. Bore 8.0 mm. Double.			
190826 Qty. 100 I.D. 8.0 mm. O.D. 12.0 mm. Th. 1.0 mm. Copper.	190828 Qty. 100 I.D. 8.0 mm. O.D. 14.0 mm. Th. 1.0 mm. Copper.	080290 Qty. 20 I.D. 8.0 mm. O.D. 12.0 mm. Th. 1.0 mm.	080009 Qty. 100 I.D. 10.0 mm. O.D. 14.0 mm. Th. 1.0 mm. Copper.	190806 Qty. 100 I.D. 10.0 mm. O.D. 16.0 mm. Th. 1.0 mm. Copper.	190808 Qty. 100 I.D. 12.0 mm. O.D. 16.0 mm. Th. 1.5 mm. Copper.	190809 Qty. 100 I.D. 12.0 mm. O.D. 18.0 mm. Th. 1.5 mm. Copper.
190812 Qty. 100 I.D. 14.0 mm. O.D. 18.0 mm. Th. 1.5 mm. Copper.	190815 Qty. 100 I.D. 14.0 mm. O.D. 14.0 mm. Th. 1.5 mm. Copper.	190817 Qty. 100 I.D. 12.0 mm. O.D. 16.0 mm. Th. 1.5 mm. Copper.	191489 Qty. 100 I.D. 16.0 mm. O.D. 24.5.0 mm. Th. 1.5 mm. Copper.			

806002 Sealing Rings II

Contains no Asbestos			
 080018 Qty. 20 Repl. CAV 5936-355C. Steel / Rubber. I.D. 5.0 mm. O.D. 11.0 mm. Th. 2.0 mm.	 080019 Qty. 20 Repl. CAV 7022-180B. Steel / Rubber. I.D. 5.2 mm. O.D. 8.4 mm. Th. 1.0 mm.	 080020 Qty. 20 Repl. CAV 7022-180C. Steel / Rubber. I.D. 9.0 mm. O.D. 13.2 mm. Th. 1.3 mm.	 080021 Qty. 20 Repl. CAV 7022-180. Steel / Rubber. I.D. 8.7 mm. O.D. 14.2 mm. Th. 1.3 mm.
 080022 Qty. 20 Repl. CAV 7022-180E. Steel / Rubber. I.D. 11.2 mm. O.D. 18.4 mm. Th. 2.0 mm.	 080024 Qty. 20 Repl. BOSCH 2410 113 004, -006. Steel / Rubber. I.D. 7.0 mm. O.D. 11.5 mm. Th. 1.9 mm.	 080025 Qty. 20 Repl. CAV 7022-180P. Steel / Rubber. I.D. 12.5 mm. O.D. 18 mm. Th. 2.3 mm.	 080026 Qty. 20 "Asbestos" / copper. I.D. 8.0 mm. O.D. 13.2 mm. Th. 2.0 mm.
 080027 Qty. 20 "Asbestos" / copper. I.D. 10.0 mm. O.D. 15.0 mm. Th. 2.3 mm.	 080028 Qty. 20 "Asbestos" / copper. I.D. 12.0 mm. O.D. 17.0 mm. Th. 2.3 mm.	 080029 Qty. 20 "Asbestos" / copper. I.D. 14.0 mm. O.D. 20.2 mm. Th. 2.5 mm.	 080030 Qty. 20 "Asbestos" / copper. I.D. 16.0 mm. O.D. 22.0 mm. Th. 2.8 mm.

806028 N Sealing Rings III

 080024 Qty. 10 Repl. BOSCH 2410 113 004, -006. I.D. 7.0 mm. O.D. 11.5 mm. Th. 1.9 mm.	 080018 Qty. 10 Repl. CAV 5936-355C. I.D. 5.0 mm. O.D. 11.0 mm. Th. 2.0 mm.	 080019 Qty. 10 Repl. CAV 7022-180B. I.D. 5.2 mm. O.D. 8.4 mm. Th. 1.0 mm.	 080020 Qty. 10 Repl. CAV 7022-180C. I.D. 9.0 mm. O.D. 13.2 mm. Th. 1.3 mm.
 080021 Qty. 10 Repl. CAV 722-180. I.D. 8.7 mm. O.D. 14.2 mm. Th. 1.3 mm.	 080022 Qty. 10 Repl. CAV 7022-180E. I.D. 11.2 mm. O.D. 18.4 mm. Th. 2.0 mm.	 080025 Qty. 10 Repl. CAV 7022-180P. I.D. 12.5 mm. O.D. 18 mm. Th. 2.3 mm.	 080865 Qty. 10 I.D. 8.0 mm. O.D. 16.0 mm. Th. 1.0 mm.
 080866 Qty. 10 I.D. 10.0 mm. O.D. 18.0 mm. Th. 1.5 mm.	 080867 Qty. 10 I.D. 12.0 mm. O.D. 20.0 mm. Th. 1.5 mm.	 080868 Qty. 10 I.D. 14.0 mm. O.D. 18.5 mm. Th. 1.5 mm.	 080869 Qty. 10 I.D. 16.0 mm. O.D. 24.0 mm. Th. 1.5 mm.
 080870 Qty. 10 I.D. 18.0 mm. O.D. 26.0 mm. Th. 1.5 mm.	 080871 Qty. 10 I.D. 20.0 mm. O.D. 28.0 mm. Th. 1.5 mm.	 080872 Qty. 10 I.D. 22.0 mm. O.D. 30.3 mm. Th. 2.0 mm.	

Angle Joints & Fork Heads

806017

<p>080653 Qty. 10 Type AS with threaded journal, hex nut and lock pin. DIN 71802. Thread: M5-0.80.</p>		<p>080654 Qty. 10 Type AS with threaded journal, hex nut and lock pin. DIN 71802. Thread: M6-1.00.</p>		<p>080655 Qty. 5 Type AS with threaded journal, hex nut and lock pin. DIN 71802. Thread: M8-1.25.</p>		<p>080656 Qty. 5 Type AS with threaded journal, hex nut and lock pin. DIN 71802. Thread: M10-1.50.</p>
<p>080658 Qty. 10 W/ rivet neck for angle joints. Thread 6-1.0 mm. Ball O.D. 10 mm.</p>	<p>080659 Qty. 5 Bore I.D. 6 mm. Thread M6. L. 12 mm. Slot wide 6 mm.</p>	<p>080660 Qty. 5 Bore I.D. 8 mm. Thread M8. L. 16 mm. Slot wide 8 mm.</p>	<p>080661 Qty. 10 Bore I.D. 8 mm. Thread M8. L. 32 mm. Slot wide 8 mm.</p>			
<p>080662 Qty. 10 W/ hole for cotter pin. Steel. DIN 1434. 6 x 18 mm.</p>	<p>191575 Qty. 200 Cotter pin. Steel. DIN 94. 1.6 x 16 mm.</p>	<p>080663 Qty. 10 W/ hole for cotter pin. Steel. DIN 1434. 8 x 22 mm.</p>	<p>190632 Qty. 100 Cotter pin. Steel. DIN 94. 2.0 x 32 mm.</p>	<p>080664 Qty. 10 W/ hole for cotter pin. Steel. DIN 1434. 10 x 28 mm.</p>	<p>190638 Qty. 100 Cotter pin. Steel. DIN 94. 3.2 x 32 mm.</p>	<p>080657 Qty. 5 Type AS with threaded journal, hex nut and lock pin. DIN 71802. Thread: M12-1.75.</p>
<p>080665 Qty. 10 W/ hole for cotter pin. Steel. DIN 1434. 12 x 35 mm.</p>	<p>191587 Qty. 50 Cotter pin. Steel. DIN 94. 4.0 x 25 mm.</p>	<p>080666 Qty. 10 W/ hole for cotter pin. Steel. DIN 1434. 14 x 40 mm.</p>	<p>191577 Qty. 100 Cotter pin. Steel. DIN 94. 4.0 x 36 mm.</p>			

Cotter Pins, Fork Heads & Joints















806022

<p>080662 Qty. 10 W/ hole for cotter pin. Steel. DIN 1434. 6 x 18 mm.</p>	<p>080663 Qty. 10 W/ hole for cotter pin. Steel. DIN 1434. 8 x 22 mm.</p>	<p>080664 Qty. 10 W/ hole for cotter pin. Steel. DIN 1434. 10 x 28 mm.</p>	<p>080665 Qty. 10 W/ hole for cotter pin. Steel. DIN 1434. 12 x 35 mm.</p>	<p>080666 Qty. 10 W/ hole for cotter pin. Steel. DIN 1434. 14 x 40 mm.</p>
<p>080843 Qty. 10 Thread M5. Bore I.D. 5 mm. L. 10 mm. Slot wide 5 mm.</p>	<p>080659 Qty. 10 Thread M6. Bore I.D. 6 mm. L. 12 mm. Slot wide 6 mm.</p>	<p>080660 Qty. 10 Thread M8. Bore I.D. 8 mm. L. 16 mm. Slot wide 8 mm.</p>	<p>080661 Qty. 10 Thread M8. Bore I.D. 8 mm. L. 32 mm. Slot wide 8 mm.</p>	
<p>191575 Qty. 200 Cotter pin. Steel. DIN 94. 1.6 x 16 mm.</p>	<p>190632 Qty. 200 Cotter pin. Steel. DIN 94. 2.0 x 32 mm.</p>	<p>190633 Qty. 200 Cotter pin. Steel. DIN 94. 2.0 x 40 mm.</p>	<p>190634 Qty. 200 Cotter pin. Steel. DIN 94. 2.5 x 25 mm.</p>	
<p>191576 Qty. 200 Cotter pin. Steel. DIN 94. 3.2 x 25 mm.</p>	<p>190638 Qty. 200 Cotter pin. Steel. DIN 94. 3.2 x 32 mm.</p>	<p>191587 Qty. 100 Cotter pin. Steel. DIN 94. 4.0 x 25 mm.</p>	<p>191577 Qty. 100 Cotter pin. Steel. DIN 94. 4.0 x 36 mm.</p>	

806019 Injector Washers & Overflow

 <p>080581 Qty. 2 Overflow. Keywith 27. Outlet 1.</p>	 <p>080583 Qty. 2 Overflow. Keywith 27. Outlet 2.</p>	 <p>080585 Qty. 2 Overflow. Keywith 27. Outlet 3.</p>	 <p>080351 Qty. 10 Repl. 093245-0040. Injector washer. Aluminium. 12.6 / 23 x 1 mm.</p>
 <p>080582 Qty. 2 Overflow. Keywith 24. Outlet 1.</p>	 <p>080584 Qty. 2 Overflow. Keywith 24. Outlet 2.</p>	 <p>080586 Qty. 2 Overflow. Keywith 24. Outlet 3.</p>	 <p>080389 Qty. 10 Repl. 9431 610 156. Injector washer. Copper. 12.1 / 23 x 1 mm.</p>
 <p>080457 Qty. 10 Repl. 093245-0140, 23654-64010. Injector washer. Aluminium. 12 / 18.5 x 1 mm.</p>	 <p>080458 Qty. 10 Repl. 23654-46010. Injector washer. Aluminium. 12.5 / 22.5 x 1 mm.</p>	 <p>080459 Qty. 10 Injector washer. Copper. 12 / 19.5 x 1 mm..</p>	 <p>080460 Qty. 10 Injector washer. Aluminium. 15 / 25.5 x 1 mm..</p>
 <p>080723 Qty. 10 Repl. 16635-J5570. Injector washer. Copper. 12.2 / 22 x 1 mm.</p>	 <p>080778 Qty. 10 Repl. 093245-0110. Injector washer. Aluminium. 12 / 22.5 x 1 mm.</p>	 <p>080779 Qty. 10 Repl. 23654-46010. Injector washer. (Improved version.) Aluminium. 12 / 23.5 x 1 mm.</p>	

806015 Ring Nipples & Hose Sleeves

 <p>080259 Qty. 10 For hose O.D. 11.0 mm. Bore 6.2 mm. Steel, zinc plated.</p>	 <p>080260 Qty. 10 For hose O.D. 11.5 mm. Bore 7.3 mm. Steel, zinc plated.</p>	 <p>080261 Qty. 10 For hose O.D. 12.5 mm. Bore 7.5 mm. Steel, zinc plated.</p>	 <p>080262 Qty. 10 For hose O.D. 13.5 mm. Bore 9.3 mm. Steel, zinc plated.</p>	 <p>080263 Qty. 10 For hose O.D. 14.5 mm. Bore 9.4 mm. Steel, zinc plated.</p>
 <p>080264 Qty. 10 For hose O.D. 16.0 mm. Bore 11.5 mm. Steel, zinc plated.</p>	 <p>080265 Qty. 10 For hose O.D. 17.0 mm. Bore 11.5 mm. Steel, zinc plated.</p>	 <p>080237 Qty. 5 For hose I.D. 6.0 mm. Bore 8.0 mm. DIN 7622.</p>	 <p>080238 Qty. 5 For hose I.D. 6.0 mm. Bore 14.0 mm. DIN 7622.</p>	
 <p>080239 Qty. 5 For hose I.D. 7.0 mm. Bore 10.0 mm. DIN 7622.</p>	 <p>080240 Qty. 5 For hose I.D. 7.0 mm. Bore 12.0 mm. DIN 7622.</p>	 <p>080241 Qty. 5 For hose I.D. 9.0 mm. Bore 12.0 mm. DIN 7622.</p>	 <p>080242 Qty. 5 For hose I.D. 9.0 mm. Bore 14.0 mm. DIN 7622.</p>	
 <p>080243 Qty. 5 For hose I.D. 11.0 mm. Bore 14.0 mm. DIN 7622.</p>	 <p>080245 Qty. 5 For hose I.D. 6.0 mm. Bore 8.0 mm.</p>	 <p>080246 Qty. 5 For hose I.D. 8.0 mm. Bore 12.0 mm.</p>	 <p>080247 Qty. 5 For hose I.D. 10.0 mm. Bore 14.0 mm.</p>	

Hollow Screws & Hose Nipples

806020

<p>080251 Qty. 5 Thread M8-1.0 mm. Bore 2.3 mm.</p>	<p>080252 Qty. 5 Thread M10-1.0 mm. Bore 4.0 mm.</p>	<p>080255 Qty. 10 Thread M14-1.5 mm. Bore 8.0 mm.</p>	<p>080256 Qty. 10 Thread M16-1.5 mm. Bore 10.0 mm.</p>		
<p>080253 Qty. 5 Thread M10-1.5 mm. Bore 4.0 mm.</p>	<p>080254 Qty. 5 Thread M12-1.5 mm. Bore 6.0 mm.</p>	<p>080257 Qty. 10 Thread M8-1.0 mm. Bore 2.0 mm. Double.</p>	<p>080258 Qty. 10 Thread M14-1.5 mm. Bore 8.0 mm. Double.</p>	<p>080237 Qty. 3 Bore 8.0. For hose I.D. 6.0.</p>	<p>080238 Qty. 3 Bore 14.0. For hose I.D. 6.0.</p>
<p>080239 Qty. 3 Bore 10.0. For hose I.D. 7.0.</p>	<p>080240 Qty. 3 Bore 12.0. For hose I.D. 7.0.</p>	<p>080241 Qty. 3 Bore 12.0. For hose I.D. 9.0.</p>	<p>080242 Qty. 3 Bore 14.0. For hose I.D. 9.0.</p>		
<p>080243 Qty. 3 Bore 14.0. For hose I.D. 11.0.</p>	<p>080003 Qty. 3 Bore 16.0. For hose I.D. 12.0.</p>	<p>080246 Qty. 3 Bore 12.0. For hose I.D. 6.0.</p>	<p>080247 Qty. 3 Bore 14.0. For hose I.D. 11.0.</p>		

Pipe & Hose Nipples













806021

<p>080274 Qty. 5 For hose I.D. 5.0 mm. L. 26.0 mm.</p>	<p>080275 Qty. 5 For hose I.D. 8.0 mm. L. 32.0 mm.</p>	<p>080276 Qty. 5 For hose I.D. 10.0 mm. L. 34.0 mm.</p>	<p>080667 Qty. 5 M10-1.0 mm.</p>
<p>080829 Qty. 3 Thread M10-1.0 mm. For hose I.D. 6.0 mm.</p>	<p>080830 Qty. 3 Thread M12-1.5 mm. For hose I.D. 6.0 mm.</p>	<p>080831 Qty. 3 Thread M14-1.5 mm. For hose I.D. 8.0 mm.</p>	<p>080297 Qty. 5 M12-1.5 mm.</p>
			<p>080668 Qty. 5 M14-1.5 mm.</p>
			<p>080669 Qty. 5 M16-1.5 mm.</p>

806018 Pipe Nipples & Brass Olives

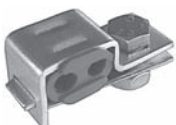
 <p>080287 Qty. 2 Pipe 6.0 mm. Thread 12-1.5 mm. L. 39 mm.</p>	 <p>080288 Qty. 2 Pipe 8.0 mm. Thread 14-1.5 mm. L. 40 mm.</p>	 <p>080289 Qty. 2 Pipe 10.0 mm. Thread 16-1.5 mm. L. 42 mm.</p>	 <p>080277 Qty. 20 I.D. 4.1 mm. For pipe O. D. 4.0 mm.</p>
 <p>080278 Qty. 20 I.D. 5.1 mm. For pipe O. D. 5.0 mm.</p>	 <p>080279 Qty. 20 I.D. 6.1 mm. For pipe O. D. 6.0 mm.</p>	 <p>080280 Qty. 20 I.D. 8.1 mm. For pipe O. D. 8.0 mm.</p>	 <p>080281 Qty. 20 I.D. 10.1 mm. For pipe O. D. 10.0 mm.</p>
 <p>080282 Qty. 20 I.D. 12.1 mm. For pipe O. D. 12.0 mm.</p>	 <p>080269 Qty. 5 I.D. 3.0 mm. For hose I. D. 5.0 mm.</p>	 <p>080270 Qty. 5 I.D. 4.0 mm. For hose I. D. 6.0 mm.</p>	 <p>080268 Qty. 5 I.D. 6.0 mm. For hose I. D. 8.0 mm.</p>
 <p>080271 Qty. 5 I.D. 6.0 mm. For hose I. D. 8.0 mm.</p>	 <p>080272 Qty. 5 I.D. 8.0 mm. For hose I. D. 10.0 mm.</p>	 <p>080273 Qty. 5 I.D. 10.0 mm. For hose I. D. 12.0 mm.</p>	

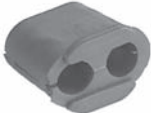
806001 Injection Pipe Holders & Nut Sets

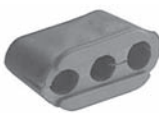
 <p>080054 Qty. 6 Injection pipe nut set. M12-1.5. For 6 mm. injection pipe.</p>	 <p>080055 Qty. 4 Injection pipe nut set. M14-1.5. For 6 mm. injection pipe.</p>	 <p>080058 Qty. 10 Serv. CAV. Steel olive. I.D. 6 mm.</p>	 <p>080047 Qty. 6 Serv. Mercedes. Injection pipe holder. 3 pipes.</p>	 <p>080049 Qty. 6 Serv. Mercedes. Injection pipe holder. 3 pipes.</p>	 <p>080043 Qty. 5 Injection pipe holder. 3 pipes.</p>
 <p>080056 Qty. 10 Steel ring for 080054. 12 mm.</p>	 <p>080057 Qty. 10 Steel ring for 080055. 14 mm.</p>	 <p>080046 Qty. 10 Serv. Mercedes. Injection pipe holder. 1 pipes.</p>	 <p>080048 Qty. 10 Serv. Mercedes. Injection pipe holder. 2 pipes.</p>	 <p>080042 Qty. 5 Injection pipe holder. 2 pipes.</p>	
 <p>080044 Qty. 5 Injection pipe holder. 2 pipes.</p>	 <p>080041 Qty. 5 Injection pipe holder. 4 pipes.</p>		 <p>080050 Qty. 6 Rubber for injection pipe holder. 2 pipes.</p>	 <p>080052 Qty. 6 Rubber for injection pipe holder. 2 pipes.</p>	
 <p>080045 Qty. 5 Injection pipe holder. 3 pipes.</p>	 <p>080051 Qty. 6 Rubber for injection pipe holder. 3 pipes.</p>		 <p>080053 Qty. 6 Rubber for injection pipe holder. 2 pipes.</p>		

Glow Plugs I

806023

 <p>100177 Qty. 2 TA50E. Serv. Caterpillar, Ford. Plug 11.5 V. Battery 12 V. Amp. 13. Thread UNF 7/8-14"</p>	 <p>100245 Qty. 4 PI - 45. Serv. Bedford, Isuzu. Plug 5 V. Battery 12 V. Amp. 11. Thread 10-1.25.</p>	 <p>100254 Qty. 4 PN - 128. Serv. Nissan, Vauxhall. Plug 10.5 V. Battery 12 V. Amp. 6.5. Thread 10-1.25.</p>	 <p>100257 Qty. 4 PT - 107. Serv. Daihatsu, Toyota. Plug 7 V. Battery 12 V. Amp. 8.5. Thread 10-1.25.</p>	 <p>100258 Qty. 4 PT - 140. Serv. Toyota. Plug 7 V. Battery 12 V. Amp. 8. Thread 10-1.25.</p>	 <p>100271 Qty. 4 PN - 132. Serv. Toyota. Plug 11 V. Battery 12 V. Amp. 10. Thread 10-1.25.</p>	 <p>100276 Qty. 6 PN - 131. Serv. Toyota. Plug 23 V. Battery 24 V. Amp. 4.8. Thread 10-1.25.</p>	 <p>100277 Qty. 4 PT - 147. Serv. Toyota. Plug 6 V. Battery 12 V. Amp. 8. Thread 10-1.25.</p>
 <p>100287 Qty. 4 PN - 135. Serv. Toyota. Plug 11 V. Battery 12 V. Amp. 10. Thread 10-1.25.</p>	 <p>100291 Qty. 4 PT - 151. Serv. Toyota. Plug 11 V. Battery 12 V. Amp. 6. Thread 10-1.25.</p>	 <p>100303 Qty. 4 Serv. Citroen, Metro. Plug 11 V. Battery 12 V. Amp. 7. Thread 12-1.25.</p>	 <p>100324 Qty. 3 Serv. Nissan. Plug 6.5 V. Battery 12 V. Amp. 5.5. Thread 10-1.25.</p>	 <p>100325 Qty. 3 Serv. Nissan. Plug 6.5 V. Battery 12 V. Amp. 5.5. Thread 10-1.25.</p>	 <p>100331 Qty. 6 Serv. Mercedes. Plug 11.5 V. Battery 12 V. Amp. 10. Thread 10-1.25.</p>	 <p>100511 Qty. 6 Serv. Alfa Romeo, ARO. Plug 11 V. Battery 12 V. Amp. 22. Thread 12-1.25.</p>	 <p>100512 Qty. 6 Serv. Audi, Seat, Skoda. Plug 11 V. Battery 12 V. Amp. 22. Thread 12-1.25.</p>

Glowplugs II

N 806027

 <p>100325 Qty. 3 Plug 6.5 V. Battery 12 V. Amp. 5.5. Thread M10-1.25.</p>	 <p>100331 Qty. 6 Plug 11.5 V. Battery 12 V. Amp. 10. Thread M10-1.25.</p>	 <p>100436 Qty. 4 Plug 11 V. Battery 12 V. Amp. 10. Thread M10-1.25.</p>	 <p>100510 Qty. 4 Plug 11 V. Battery 12 V. Amp. 7. Thread M10-1.25.</p>	 <p>100511 Qty. 4 Plug 11 V. Battery 12 V. Amp. 22. Thread M12-1.25.</p>	 <p>100512 Qty. 4 Plug 11 V. Battery 12 V. Amp. 22. Thread M12-1.25.</p>	 <p>100513 Qty. 4 Plug 11 V. Battery 12 V. Amp. 7. Thread M10-1.25.</p>	 <p>100519 Qty. 4 Plug 11 V. Battery 12 V. Amp. 6. Thread M10-1.25.</p>
 <p>100520 Qty. 4 Plug 11 V. Battery 12 V. Amp. 6.5. Thread M10-1.25.</p>	 <p>100580 Qty. 2 Plug 8 V. Battery 12 V. Amp. 16. Thread M22-1.50.</p>	 <p>100310 Qty. 4 Plug 11/6.2 V. Battery 12 V. Amp. 14. Thread M10-1.25.</p>	 <p>100246 Qty. 4 Plug 12 V. Battery 12 V. Amp. 8.5. Thread M10-1.25.</p>	 <p>100287 Qty. 4 Plug 11 V. Battery 12 V. Amp. 10. Thread M10-1.25.</p>	 <p>100291 Qty. 4 Plug 11 V. Battery 12 V. Amp. 6. Thread M10-1.25.</p>	 <p>100303 Qty. 4 Plug 11 V. Battery 12 V. Amp. 7. Thread M12-1.25.</p>	 <p>100324 Qty. 4 Plug 6.5 V. Battery 12 V. Amp. 5.5. Thread M10-1.25.</p>

806030 **Glow Plugs III**

 <p>100261 Qty. 4 Plug 10.5 V. Battery 12 V. Amp. 16.5. Thread M10-1.25.</p>	 <p>100335 Qty. 4 Plug 11 V. Battery 12 V. Amp. 9. Thread M10-1.</p>	 <p>100515 Qty. 4 Plug 11 V. Battery 12 V. Amp. 6. Thread M10-1.25.</p>	 <p>100527 Qty. 4 Plug 11 V. Battery 12 V. Amp. 10. Thread M10-1.</p>	 <p>100537 Qty. 4 Plug 11.5 V. Battery 12 V. Amp. 8-10. Thread M10-1.</p>	 <p>100538 Qty. 4 Plug 12 V. Battery 12 V. Amp. 8-10. Thread M10-1.</p>	 <p>100555 Qty. 4 Plug 11 V. Battery 12 V. Amp. 10. Thread M10-1.25.</p>	 <p>100593 Qty. 4 Plug 11 V. Battery 12 V. Amp. 10. Thread M10-1.</p>
 <p>100532 Qty. 4 Plug 10 V. Battery 12 V. Amp. 8-10. Thread M10-1.</p>	 <p>100557 Qty. 4 Plug 11 V. Battery 12 V. Amp. 10. Thread M10-1.25.</p>	 <p>100563 Qty. 4 Plug 11 V. Battery 12 V. Amp. 12. Thread M10-1.25.</p>	 <p>100592 Qty. 4 Plug 11 V. Battery 12 V. Amp. 9-13. Thread M10-1.</p>	 <p>100531 Qty. 4 Plug 10 V. Battery 12 V. Amp. 10. Thread M12-1.25.</p>		 <p>100545 Qty. 4 Plug 11.5 V. Battery 12 V. Amp. 10. Thread M12-1.25.</p>	

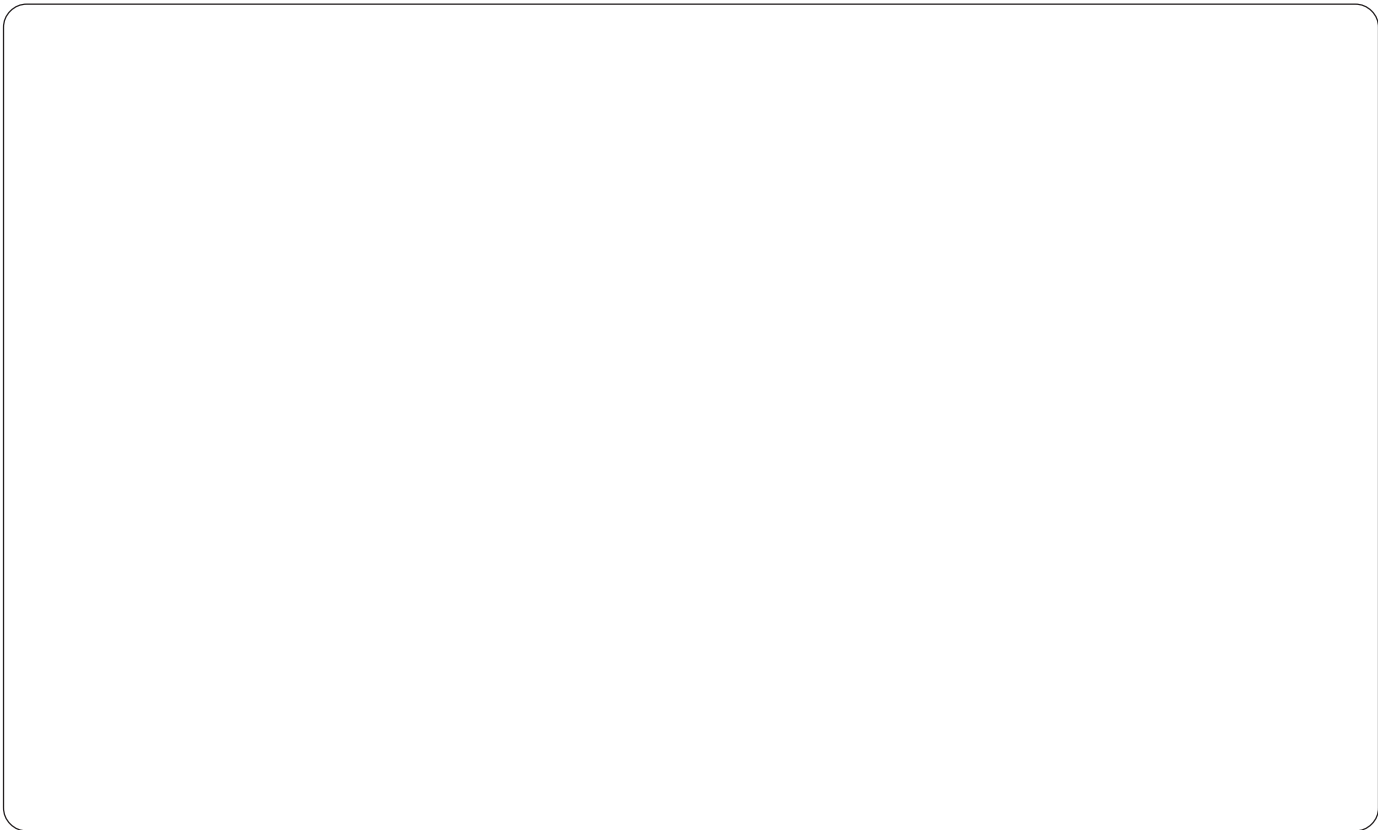
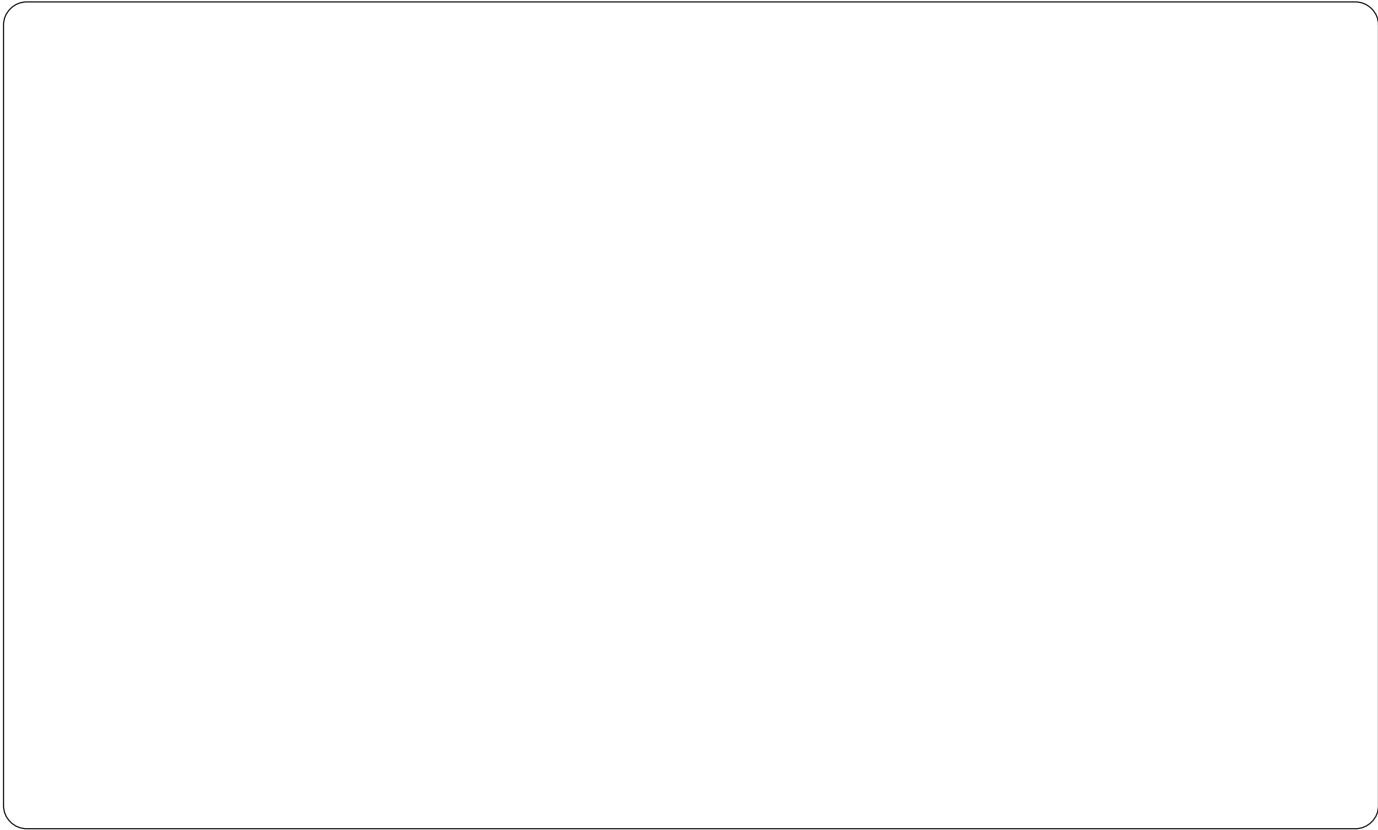



ASSORTMENTS

PART 7

Notes

807002 **Hose Nipples**

 <p>070009 Qty. 3 Screw terminal R 1/8". For 6 mm. hose I.D.</p>	 <p>070067 Qty. 3 Screw terminal R 1/4". For 10 mm. hose I.D.</p>	 <p>080855 Qty. 3 Screw terminal R 1/2". For 10 mm. hose I.D.</p>	 <p>070077 Qty. 3 Screw terminal 1/8-27 NPTF. For 6 mm. hose I.D.</p>
 <p>080955 Qty. 3 Screw terminal 1/8-27 NPTF. For 8 mm. hose I.D.</p>	 <p>080857 Qty. 3 Screw terminal 1/2"-20 UNF. For 8 mm. hose I.D.</p>	 <p>080960 Qty. 3 Screw terminal 1/2"-20 UNF. For 10 mm. hose I.D.</p>	 <p>080954 Qty. 3 Screw terminal M14-1.5. For 6 mm. hose I.D.</p>
 <p>080854 Qty. 3 Screw terminal M14-1.5. For 8 mm. hose I.D.</p>	 <p>080959 Qty. 3 Screw terminal M14-1.5. For 10 mm. hose I.D.</p>	 <p>080858 Qty. 3 Screw terminal M16-1.5. For 8 mm. hose I.D.</p>	 <p>070070 Qty. 3 Screw terminal M16-1.5. For 10 mm. hose I.D.</p>
 <p>080958 Qty. 3 Screw terminal M18-1.5. For 10 mm. hose I.D.</p>			



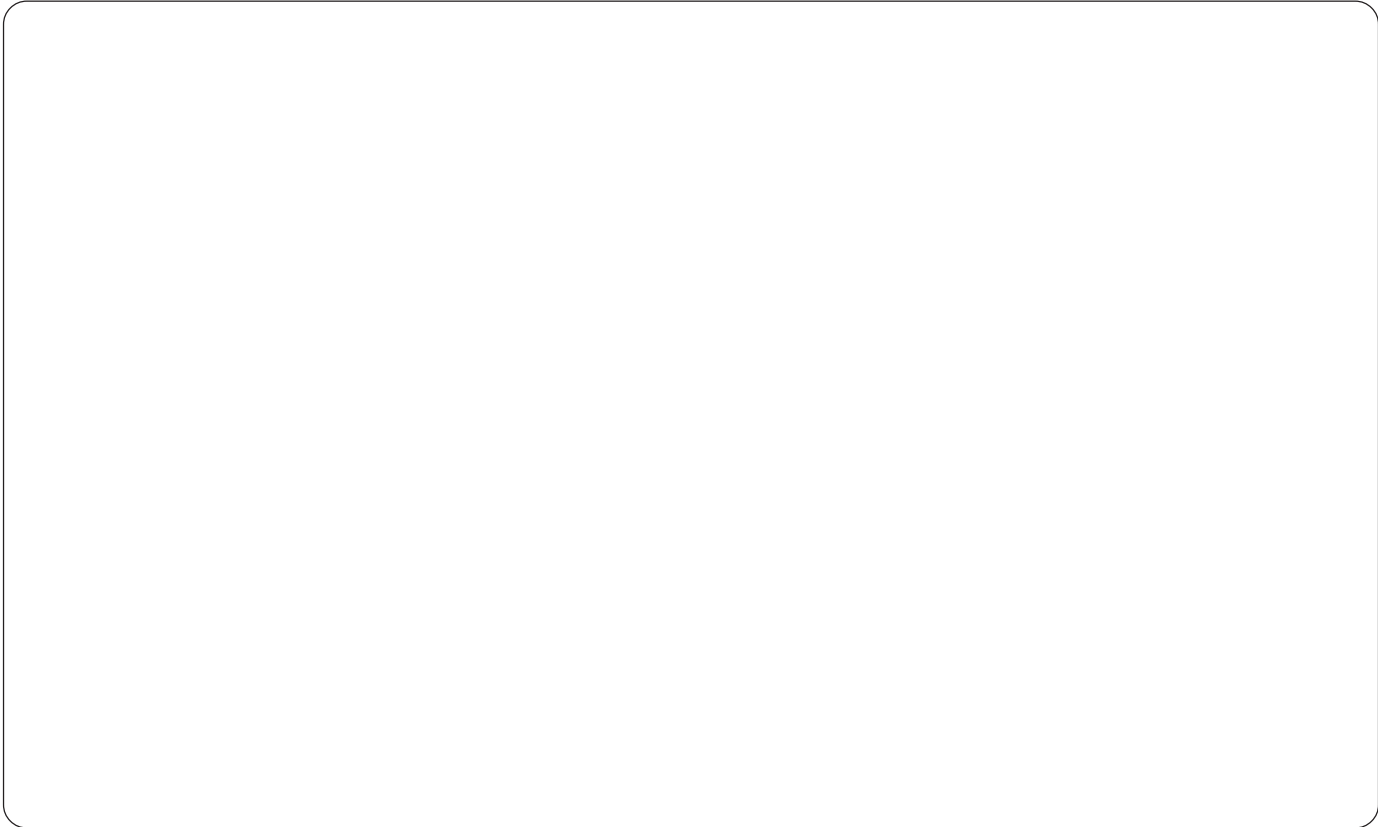
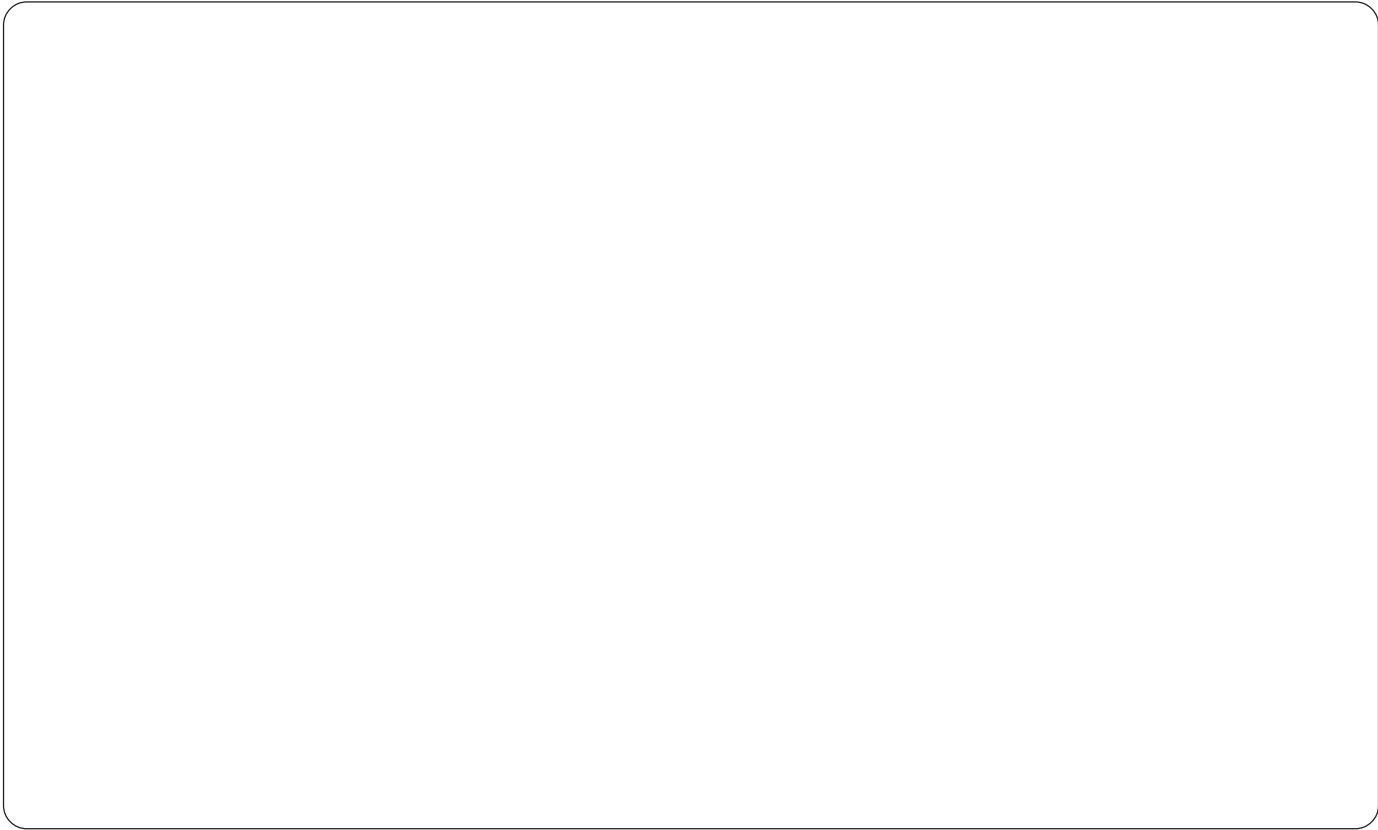



ASSORTMENTS

PART 8

Notes

A large, empty rectangular box with rounded corners, intended for taking notes. The box is currently blank.











808003 Switches

Fixing hole 12.5 mm.						
<p>180141 Qty. 1 12 V. 5 Amp./24 V. 2.5 Amp. Short arm. on/on. 3 terminals. Black knob.</p>	<p>180140 Qty. 1 12 V. 10 Amp./24 V. 5 Amp. Short arm. on/off. 2 terminals. Black knob.</p>	<p>180103 Qty. 1 12 V. 25 Amp./24 V. 12.5 Amp. Short neck. on/off. 2 screw terminals. Black knob. Fixing hole 8 mm.</p>	<p>180036 Qty. 1 12 V. 16 Amp./24 V. 8 Amp. On/off/on. 3 terminals. Black knob.</p>	<p>180048 Qty. 1 12/24 V. On/off/on. 3 screw terminal. Black knob.</p>	<p>180018 Qty. 1 12 V. 10 Amp./24 V. 5 Amp. Long arm. on/off. 2 terminals. Black knob.</p>	<p>180088 Qty. 1 12 V. 16 Amp./24 V. 8 Amp. Short arm. off/(on). 2 terminals. Black knob.</p>
<p>180089 Qty. 1 12 V. 16 Amp./24 V. 8 Amp. Long arm. off/on. 2 terminals. Black knob.</p>	<p>180123 Qty. 1 on/off. 2 screw terminal. White knob. Fixing hole 8 mm.</p>	<p>180104 Qty. 1 As Cargo 180103 but with long neck.</p>	<p>180091 Qty. 1 12 V. 10 Amp. on/off. 3 terminals. Blue. Illuminated, short arm. Supplied w/ 12 V bulb. Fixing hole 29x12.5 mm.</p>	<p>180092 Qty. 1 12 V. 10 Amp. on/off. 3 terminals. Green. Illuminated, short arm. Supplied w/ 12 V bulb. Fixing hole 29x12.5 mm.</p>	<p>180094 Qty. 1 12 V. 10 Amp. on/off. 3 terminals. Red. Illuminated, short arm. Supplied w/ 12 V bulb. Fixing hole 29x12.5 mm.</p>	<p>180021 Qty. 1 12 / 24 V. on/off. 2 flat terminals. Amber. Illuminated. Supplied w/o bulb. Max. 3 Watt BA 7 s bulb.</p>
<p>180022 Qty. 1 12 / 24 V. on/off. 2 flat terminals. Green. Illuminated. Supplied w/o bulb. Max. 3 Watt BA 7 s bulb.</p>	<p>180023 Qty. 1 12 / 24 V. on/off. 2 flat terminals. Red. Illuminated. Supplied w/o bulb. Max. 3 Watt BA 7 s bulb.</p>	<p>180156 Qty. 1 12 V. 15 Amp./24 V. 7.5 Amp. on/off. 4 terminals. Black knob. Illuminated. Supplied w/wedge-base bulb. Water resistant. W/ kit w/ 3 lenses red/amber/green.</p>	<p>180176 Qty. 1 12 V. 10 Amp./24 V. 5 Amp. On/off. 2 terminals.</p>	<p>180177 Qty. 1 12 V. 10 Amp. on/off. 2 terminals. Blue. Illuminated. Supplied w/ 12V bulb.</p>	<p>180178 Qty. 1 12 V. 10 Amp. on/off. 2 terminals. Green. Illuminated. Supplied w/ 12V bulb.</p>	<p>180179 Qty. 1 12 V. 10 Amp. on/off. 2 terminals. Red. Illuminated. Supplied w/ 12V bulb.</p>
<p>180180 Qty. 1 12 V. 10 Amp. on/off. 2 terminals. Amber. Illuminated. Supplied w/ 12V bulb.</p>	<p>180158 Qty. 1 12 V. 15 Amp./24 V. 7.5 Amp. 5 terminals. Black knob. 4 position. Water resistant. For light, blower etc.</p>					

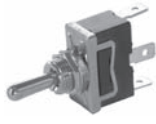
808002 Door Switches

<p>180222 Qty. 2 Serv. Ford 7/76-. L1 = 15 mm. L2 = 20 mm.</p>	<p>180254 Qty. 2 Universal type w/ 1 terminal. L1 = 10-15 mm. L2 = 20 mm. Self adjusting.</p>	<p>180255 Qty. 2 Universal type w/ 2 terminal. L1 = 10-15 mm. L2 = 0-20 mm. Self adjusting.</p>	<p>180625 Qty. 2 Universal type w/ 1 terminal. L1 = 15 mm. L2 = 40 mm. (Suitable for cutting to length).</p>	<p>180265 Qty. 2 Serv. Fiat, Seat. W/ 1 terminal. L1 = 12 mm. L2 = 9 mm.</p>	<p>180266 Qty. 2 Serv. Fiat Uno. W/ 2 terminal. L1 = 15 mm. L2 = 9 mm.</p>	<p>180262 Qty. 2 Serv. Opel, Vauxhall. W/ 1 terminal. L1 = 15 mm. L2 = 15 mm.</p>
<p>180268 Qty. 2 Universal type. W/ 1 terminal. L1 = 11 mm. 22 mm. between fixing holes.</p>	<p>180269 Qty. 2 Universal type. W/ 1 terminal. L2 = 4.5 mm. 22 mm. between fixing holes.</p>	<p>180267 Qty. 2 Serv. Fiat Tipo, Tempra. W/ 2 terminal. L2 = 32.5 mm.</p>				
<p>180263 Qty. 2 Servicing Austin, Rover. W/ 1 terminal. L1 = 13 mm. L2 = 15 mm.</p>						

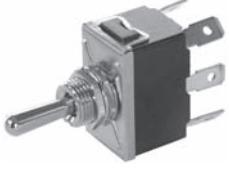
Toggle Switches **808014**

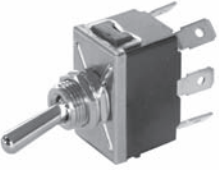
Metal Knob, Fixing hole 12.0 mm.			
 <p>180595 Qty. 5 Rubber cap. Fits Cargo 180584 - 594.</p>	 <p>180584 Qty. 2 12 V. 16 Amp. 24 V. 8 Amp. Short arm. on/off. 2 terminals.</p>	 <p>180585 Qty. 2 12 V. 16 Amp. 24 V. 8 Amp. Short arm. on/(on). 3 terminals.</p>	 <p>180586 Qty. 2 12 V. 16 Amp. 24 V. 8 Amp. Short arm. on/on. 3 terminals.</p>
 <p>180587 Qty. 2 12 V. 16 Amp. 24 V. 8 Amp. Short arm. (on)/off/(on). 3 terminals.</p>	 <p>180588 Qty. 2 12 V. 16 Amp. 24 V. 8 Amp. Short arm. on/off/(on). 3 terminals.</p>	 <p>180589 Qty. 2 12 V. 16 Amp. 24 V. 8 Amp. Short arm. on/off/on. 3 terminals.</p>	 <p>180590 Qty. 2 12 V. 16 Amp. 24 V. 8 Amp. Short arm. on/off. 4 terminals.</p>
 <p>180591 Qty. 2 12 V. 16 Amp. 24 V. 8 Amp. Short arm. on/on. 6 terminals.</p>	 <p>180592 Qty. 2 12 V. 16 Amp. 24 V. 8 Amp. Short arm. (on)/off/(on). 6 terminals.</p>	 <p>180593 Qty. 2 12 V. 16 Amp. 24 V. 8 Amp. Short arm. on/ off(on). 6 terminals.</p>	 <p>180594 Qty. 2 12 V. 16 Amp. 24 V. 8 Amp. Short arm. on/off/on. 6 terminals.</p>

Mini Rocker Switches **808015**

 <p>180597 Qty. 10 12 V. 16 Amp. / 24 V. 8 Amp. On / off. 2 terminals. Fixing hole 21.0 mm.</p>	 <p>180598 Qty. 10 12 V. 16 Amp. On / off. 3 terminals. Illuminated. Fixing hole 21.0 mm. Amber.</p>	 <p>180599 Qty. 10 12 V. 16 Amp. On / off. 3 terminals. Illuminated. Fixing hole 21.0 mm. Red.</p>	 <p>180600 Qty. 10 12 V. 16 Amp. / 24 V. 8 Amp. On / on. 3 terminals. Fixing hole 21.0 mm.</p>
 <p>180601 Qty. 10 12 V. 16 Amp. On / off. 3 terminals. Illuminated. Fixing hole 21.0 mm. Red spot diode.</p>	 <p>180628 Qty. 10 12 V. 16 Amp. On / off. 3 terminals. Illuminated. Fixing hole 21.0 mm. Green.</p>	 <p>180627 Qty. 10 12 V. 16 Amp. On / off. 3 terminals. Illuminated. Fixing hole 21.0 mm. Blue.</p>	

808004 Lambda Sensors I

Measures the amount of oxygen in exhaust and signals computer to adjust air / fuel ratio



180334 Qty. 1
One wire sensor.



180335 Qty. 1
Two wire sensor.



180336 Qty. 1
Three wire sensor.



180337 Qty. 1
Four wire sensor.



180526 Qty. 2
Gasket and flange.
Serv. Cargo 180334 and 180335 for some Japanese applications.

808005 Lambda Sensors II

Measures the amount of oxygen in exhaust and signals computer to adjust air / fuel ratio

180334 Qty. 1
One wire sensor.
Zirconia sensor.
Output 0.1 - 0.9 V.



180355 Qty. 1
One wire sensor w/ flange.
Zirconia sensor.
Output 0.1 - 0.9 V.



180335 Qty. 1
Two wire sensor.
Zirconia sensor.
Output 0.1 - 0.9 V.



180356 Qty. 1
Three wire sensor.
M12 thread
Titania sensor.
Output 0.1 - 0.5 V.



180336 Qty. 1
Three wire sensor.
Zirconia sensor.
Output 0.1 - 0.9 V.



180357 Qty. 1
Three wire sensor.
M18 thread
Titania sensor.
Output 0.1 - 0.5 V.



180337 Qty. 1
Four wire sensor.
Zirconia sensor.
Output 0.1 - 0.9 V.



180358 Qty. 1
Four wire sensor.
M18 thread
Titania sensor.
Output 0.1 - 0.5 V.



Lambda Sensors III

808006

Measures the amount of oxygen in exhaust and signals computer to adjust air / fuel ratio

180355 Qty. 1
One wire sensor w/ flange.
 M18 spark plug thread.
 Output 0.1 - 0.9 V.



180356 Qty. 1
Three wire sensor.
 M12 thread.
 Titania sensor.
 Output 1.0 - 5.0 V.



180357 Qty. 1
Three wire sensor.
 M18 thread.
 Titania sensor.
 Output 1.0 - 5.0 V.



180358 Qty. 1
Four wire sensor.
 M18 thread.
 Titania sensor.
 Output 1.0 - 5.0 V.



Lambda Sensors w/ tester

808007

Measures the amount of oxygen in exhaust and signals computer to adjust air / fuel ratio

180334 Qty. 1
One wire sensor.



180335 Qty. 1
Two wire sensor.



180336 Qty. 1
Three wire sensor.



180337 Qty. 1
Four wire sensor.



210763 Qty. 1
Oxygen sensor tool.
 Special tool to mount and remove the oxygen (Lambda) sensor.



































200691 Qty. 1
Solder.
 1/4 kilo reel, 95 % tin, 5% silver.
 2 mm. O.D..



210762 Qty. 1
Oxygen sensor tester.
 Shows if the oxygen (Lambda) sensor is working.



808008 Oil Pressure Switches



















 180630 Qty. 1 M14 x 1.5. 0.30 bar.	 180631 Qty. 1 M12 x 1.5. 0.30 bar.	 180634 Qty. 1 M10 x 1.0 cone. 0.30 bar.	 180635 Qty. 1 Repl. orig. brown switch. M10 x 1.0. 0.30 bar.	 180636 Qty. 1 *1/4-18-NPT cone. 0.30 bar.	 180638 Qty. 1 *1/8 Gas cone. 0.40 bar.	 180639 Qty. 1 *1/8 Gas cone. 0.40 bar.	 180640 Qty. 1 *1/8 Gas cone. 0.40 bar.
 180641 Qty. 1 *1/8 Gas cone. 0.40 bar.	 180645 Qty. 1 M16 x 1.5. 0.60 bar.	 180648 Qty. 1 Repl. orig. brown switch. M12-1.5. 0.35 bar.	 180649 Qty. 1 *1/8-27-NPT cone. 0.50 bar.	 180650 Qty. 1 M12-1.5 cone. 0.65 bar.	 180651 Qty. 1 *1/8-27-NPT cone. 0.60 bar.	 180653 Qty. 1 *1/4-18-NPT cone. 0.40 bar.	 180654 Qty. 1 M18-1.5. 0.35 bar.
 180655 Qty. 1 *1/8 Gas cone. 0.20 bar.	 180656 Qty. 1 *1/4-18-NPT cone. 0.40 bar.	 180657 Qty. 1 *1/8 Gas cone. 0.20 bar.	 180658 Qty. 1 Repl. orig. white switch. M10-1.0. 1.80 bar.	 180660 Qty. 1 *1/8-27-NPT cone. 0.50 bar.	 180661 Qty. 1 M12-1.5. 0.60 bar.	 180662 Qty. 1 M10-1.0 cone. 1.40 bar.	 180672 Qty. 1 M14-1.5. 0.50 bar.
 180673 Qty. 1 M14-1.5. 0.40 / 0.60 bar.	 180674 Qty. 1 M12-1.5. 0.30 bar.	 180677 Qty. 1 M18-1.8. 0.50 bar.	 180678 Qty. 1 M14-1.5. 0.30 bar.	 180679 Qty. 1 *1/8 Gas cone. 0.40 bar.	 180682 Qty. 1 M18-1.5. 0.70 bar.	 180688 Qty. 1 Repl. orig. grey switch. M10-1.0. 0.90 bar.	 180697 Qty. 1 *1/8 Gas cone. 0.20 bar.

808009 Oil Pressure Transmitters

 180702 Qty. 1 M14-1.5. 0-8 bar.	 180704 Qty. 1 M10-1.0. 0-8 bar.	 180705 Qty. 1 I.D. M14. 0-8 bar.	 180706 Qty. 1 M10-1.0. 0-8 bar.
 180707 Qty. 1 M14-1.5. 0-5 bar. Working pressure of gauge 0.60 bar.	 180712 Qty. 1 M14-1.5. 0-5 bar. Working pressure of gauge 0.60 bar.	 180714 Qty. 1 M14-1.5. 0-3 bar.	 180715 Qty. 1 *1/2-20-UNF. 0-4 bar.

































Brake Light Switches

808001

















 180726 Qty. 1 M12-1.5.	 180728 Qty. 1 M12-1.75.	 180729 Qty. 1 M12-1.5.	 180730 Qty. 1 M10-1.25.	 180731 Qty. 1 M12-1.5.
 180734 Qty. 1 M12-1.0.	 180735 Qty. 1 M12-1.5.	 180727 Qty. 1 M12-1.5.	 180736 Qty. 1 M10-1.25.	
 180738 Qty. 1 M10-1.25.	 180740 Qty. 1 M10-1.25.	 180747 Qty. 1 M12-1.5.	 180749 Qty. 1	 180753 Qty. 1 M12-1.5.
 180760 Qty. 1 Self adjustable plunger.	 180790 Qty. 1 *1/8-27-NPT cone.	 180791 Qty. 1 M10-1.0.	 180008 Qty. 1 Off in neutral position.	 180009 Qty. 1 On in neutral position.

Temperature Transmitters









808012

 180804 Qty. 1 M16-1.5 cone.	 180805 Qty. 1 M16-1.5.	 180807 Qty. 1 M10-1.0 cone.	 180808 Qty. 1 *1/8-27-NPT cone.	 180810 Qty. 1 M18-1.5.	 180811 Qty. 1 M16-1.5.	 180812 Qty. 1 *1/8-27-NPT cone. Replacing original white transmitter.	 180814 Qty. 1 *1/8-27-NPT.
 180820 Qty. 1 *1/8-27-NPT cone. Replacing original yellow transmitter.	 180824 Qty. 1 M16-1.5.	 180826 Qty. 1 M16-1.5.	 180827 Qty. 1 M16-1.5.	 180829 Qty. 1 *5/8-18-UNF.	 180830 Qty. 1 *5/8-18-UNF.	 180832 Qty. 1 *1/8 GAS cone.	 180833 Qty. 1 *1/8 GAS cone.
 180834 Qty. 1 M16-1.5.	 180835 Qty. 1 M16-1.5.	 180837 Qty. 1 M8-0.75.	 180838 Qty. 1 *1/8-27-NPT cone. Replacing original violet transmitter	 180839 Qty. 1 M10-1.0.	 180840 Qty. 1 M14-1.25.	 180841 Qty. 1 M14-1.5.	 180842 Qty. 1 M12-1.25.
 180846 Qty. 1 *1/8-27-NPT cone. Replacing original violet and old version transmitter.	 180848 Qty. 1 Replacing original black transmitter.	 180861 Qty. 1 Replacing original blue sensor.	 180869 Qty. 1 *1/8-27-NPT cone. Replacing original black transmitter	 180871 Qty. 1 *1/8-27-NPT cone. Replacing original black transmitter.	 180872 Qty. 1 Replacing original black transmitter.	 180877 Qty. 1 *1/8-27-NPT cone. Replacing original orange transmitter.	 180879 Qty. 1 M14-1.5.

8080 1 6 Engine Management Temperatur Sensors

 180861 Qty. 1 Replacing original blue sensor.	 180868 Qty. 1 M12-1.5. Replacing original sensor w/ violet ring.	 180873 Qty. 1 M12-1.5. Replacing original white sensor.	 180874 Qty. 1 M12-1.5. Replacing original white sensor.
 180875 Qty. 1 M12-1.5. Replacing original blue sensor.	 180881 Qty. 1 M12-1.5. Replacing original blue sensor.	 180883 Qty. 1 Replacing original black/yellow sensor.	 180884 Qty. 1 M12-1.5. Replacing original green sensor.
 180887 Qty. 1 M12-1.5. Replacing original red sensor.	 180893 Qty. 1 *1/8-27-NPT. Replacing original black sensor.	 180895 Qty. 1 M10-1.0. Replacing original white sensor.	 180896 Qty. 1 Replacing original black sensor.
 180897 Qty. 1 M14-1.5. Replacing original black sensor.	 180905 Qty. 1 M12-1.5. Replacing original white sensor.	 180906 Qty. 1 M12-1.5. Replacing original black sensor.	 180919 Qty. 1 M10-1.0. Replacing original black sensor.

8080 1 1 Temperature Switches

 180945 Qty. 1 M16-1.5 cone. 115° C.	 180946 Qty. 1 M22-1.5. 112° C.	 180949 Qty. 1 M10-1.0. 120° C.	 180950 Qty. 1 M18-1.5. 105° C.
 180951 Qty. 1 M18-1.25. 110° C.	 180953 Qty. 1 M14-1.25. 105° C.	 180954 Qty. 1 M14-1.25. 110° C.	 180985 Qty. 1 M14-1.5. 45° C.
 180958 Qty. 1 M14-1.25. 107° C.	 180959 Qty. 1 M14-1.5. 110° C.	 180963 Qty. 1 M14-1.25. 120° C.	 180973 Qty. 1 M14-1.25. 117° C. Replaces original switch w/ yellow ring.
 180979 Qty. 1 M8-1.25. 50° C.	 180980 Qty. 1 60° C. Replaces original blue switch.	 180981 Qty. 1 120° C.	 180983 Qty. 1 M10-1.25. 70° C.

Thermo Sensor Switches 8080 13

 181001 Qty. 1 M22-1.5. 92 -87° C.	 181005 Qty. 1 M22-1.5. 82 -67° C.	 181006 Qty. 1 M22-1.5. 92 -87° C.	 181008 Qty. 1 M22-1.5. 88 -77° C.	 181009 Qty. 1 M22-1.5. 85 -75° C.	 181015 Qty. 1 M22-1.5. 86 -81° C.	 181017 Qty. 1 M22-1.5. 95 -90° C.	 181018 Qty. 1 M22-1.5. 95 -90° C.
 181021 Qty. 1 M22-1.5. 92 -87° C.		 181060 Qty. 1 *m22-1.5 100 -95° C.		 181062 Qty. 1 *3/8 GAS cone. 72 -67° C.	 181064 Qty. 1 *M22-1.5 92 -82° C.		 181065 Qty. 1 *3/8 GAS cone. 92 -87° C. Repl. original grey thermo sensor.
 181073 Qty. 1 M14-1.5. 72 -67° C.	 181076 Qty. 1 M22-1.5. 92 -87° C. Repl. original grey thermo sensor.	 181077 Qty. 1 M14-1.5. 87 -82° C.	 181085 Qty. 1 M14-1.5. 100 -95° C.	 181088 Qty. 1 M22-1.5. 100 -95° C.		 181089 Qty. 1 M22-1.5. 92 -87° C.	
 181090 Qty. 1 M16-1.5. 97 -90° C.		 181098 Qty. 1 M24-1.5. 82 -72° C. Repl. original black thermo sensor.	 181105 Qty. 1 M22-1.5. 95 -85° C. 102 - 87° C.	 181121 Qty. 1 M22-1.5. 87 -77° C. 92 - 82° C.	 181126 Qty. 1 M22-1.5. 95 -85° C. 102 - 92° C.	 181133 Qty. 1 M22-1.5. 90 -80° C. 97 - 97° C. Repl. original blue thermo sensor.	 181141 Qty. 1 M22-1.5. 95 -90° C. 100 - 95° C. Repl. original red thermo sensor.

Reverse Light Switches 8080 10

 181147 Qty. 1 M14-1.5.	 181148 Qty. 1 M12-1.5.	 181150 Qty. 1 M12-1.5.	 181152 Qty. 1 M14-1.5.	 181156 Qty. 1 M12-1.5.	 181158 Qty. 1 M14-1.5.	 181160 Qty. 1 M12-1.5.
 181163 Qty. 1 M14-1.5.	 181165 Qty. 1 *3/8-16-UNC.		 181172 Qty. 1 M14-1.5.		 181179 Qty. 1 M14-1.5.	
 181183 Qty. 1 M16-1.5.		 181191 Qty. 1 M14-1.5.	 181194 Qty. 1 M14-1.5.		 181196 Qty. 1 M27-1.0. M12-1.0.	
 181197 Qty. 1 M27-1.0, M18-1.5.		 181200 Qty. 1 M16-1.5.	 181201 Qty. 1 M14-1.5.	 181205 Qty. 1 *3/8-16-UNC.	 181212 Qty. 1 M12-1.5.	 181214 Qty. 1 M12-1.5.



ASSORTMENTS

PART 9

Notes

A large, empty rectangular box with rounded corners, intended for taking notes. The box is currently blank.

809001 Bulb Holders

















 170135 Qty. 5 BAY 15 d.	 170596 Qty. 5 BAY 15 d.	 170138 Qty. 5 BAY 15 s.	 170791 Qty. 5 BAY 15 s. 2 x screw connection. (Grounded.)	 170136 Qty. 5 BA 9 s.	 170137 Qty. 5 BA 7 s.	 170790 Qty. 5 BA 9 s. 2 x terminal connection.	 170827 Qty. 5 Wedge-base T10. (W2.1 x 9.5d.) 2 x terminal connection.
 170139 Qty. 5 33-36 mm. feston type.	 170763 Qty. 3 Serv. VW golf, Vento. Wedge base. T10 (W2.1 x 9.5d.)	 170433 Qty. 5 For P 43, P 45 t bulbs and sealed beams etc.	 170619 Qty. 3 For P 43, P 45 t bulbs and sealed beams etc. Terminal: Cargo 191200.		 191200 Qty. 100 8.0 mm. 1.0 - 2.5 mm ² . W/non-returntag. Fits connector Cargo 170799.		 191938 Qty. 100 Flat plug terminal 8.0 mm. flag type. Fits connector Cargo 170799.
			 170799 Qty. 3 For P 43, P 45 t bulbs and sealed beams etc. Angled type. Terminal: Cargo 191938				

809008 Scooter Bulbs

 O.D. 26.5 mm 52.5 mm 170335 Qty. 5 12 V. 21 Watt. Base: BA 15d.	 O.D. 26.5 mm 52.5 mm 170336 Qty. 5 12 V. 21/5 Watt. Base: BAY 15d.	 O.D. 19 mm 35 mm 170339 Qty. 5 12 V. 10 Watt. Base: BA 15s.	 O.D. 10.3 mm 26.7 mm 170810 Qty. 5 12 V. 8 Watt. Wedge base, T10 (W2.1 x 9.5d.)
		 O.D. 18.5 mm 35 mm 170340 Qty. 5 12 V. 5 Watt. Base: BA 15s.	 O.D. 20 mm 47 mm 170811 Qty. 2 12 V. 30/30 Watt. Base: PX 15d.
 O.D. 15 mm 55 mm 170812 Qty. 2 12 V. Halogen 30/30 Watt. Base: PX 15d.	 O.D. 36 mm 70 mm 170814 Qty. 3 12 V. 25/25 Watt. Base: BA 20d.	 O.D. 36 mm 70 mm 170815 Qty. 3 12 V. 35/35 Watt. Base: BA 20d.	 O.D. 25.5 mm 42 mm 170816 Qty. 5 12 V. 15 Watt. Base: P 26s.























Feston Bulbs 12 V.

809002

<p>O.D. 6.5 mm</p>  <p>33 mm</p>  <p>170591 Qty. 20 3 Watt. Base: S 6.</p>	<p>O.D. 8 mm</p>  <p>28 mm</p>  <p>170590 Qty. 20 3 Watt. Base: S 7.</p>	<p>O.D. 10 mm</p>  <p>28 mm</p>  <p>170005 Qty. 20 10 Watt. Base: S 8.5.</p>	<p>O.D. 10.5 mm</p>  <p>36 mm</p>  <p>170341 Qty. 20 5 Watt. Base: S 8.5.</p>
<p>O.D. 10.5 mm</p>  <p>36 mm</p>  <p>170411 Qty. 20 10 Watt. Base: S 8.5.</p>	<p>O.D. 10.5 mm</p>  <p>41 mm</p>  <p>170343 Qty. 20 5 Watt. Base: S 8.5.</p>	<p>O.D. 10.5 mm</p>  <p>41 mm</p>  <p>170344 Qty. 20 10 Watt. Base: S 8.5.</p>	<p>O.D. 15 mm</p>  <p>41 mm</p>  <p>170588 Qty. 20 18 Watt. Base: S 8.5.</p>

Wedge-Base Bulbs 12 V. I

809003

<p>O.D. 10.3 mm</p>  <p>26.7 mm</p>  <p>170331 Qty. 20 3 Watt. Wedge Base: T10 (W 2.1 x 9.5d).</p>	<p>O.D. 10.3 mm</p>  <p>26.7 mm</p>  <p>170347 Qty. 20 5 Watt. Wedge Base: T10 (W 2.1 x 9.5d).</p>	<p>O.D. 5 mm</p>  <p>23.5 mm</p>  <p>170357 Qty. 20 1.2 Watt. Base: B 8.5 d. (BAX 10d).</p>	<p>O.D. 5 mm</p>  <p>20 mm</p>  <p>170410 Qty. 20 1.2 Watt. Wedge Base: T5 (W 2 x 4.6d).</p>			
<p>O.D. 5 mm</p>  <p>23.5 mm</p>  <p>170545 Qty. 20 1.2 Watt. Base: B8.7d</p>	<p>O.D. 5 mm</p>  <p>23.5 mm</p>  <p>170610 Qty. 10 2 Watt. Base: B 8.5d. (BAX 10d).</p>	<p>O.D. 5 mm</p>  <p>23.5 mm</p>  <p>170612 Qty. 10 1.2 Watt. Base: B 8.3d. (BAX 10s).</p>	<p>O.D. 5 mm</p>  <p>23.5 mm</p>  <p>170611 Qty. 10 2 Watt. Base: B 8.3d. (BAX 10s).</p>	<p>O.D. 5 mm</p>  <p>20 mm</p>  <p>170617 Qty. 10 1.2 Watt. Wedge Base, T5 (W 2 x 4.6d). Frosted.</p>	<p>D.E. 5 mm</p>  <p>21 mm</p>  <p>170698 Qty. 10 1.8 Watt. Base: EBS R11. Alba-type.</p>	<p>O.D. 4 mm</p>  <p>10.5 mm</p>  <p>26 mm</p> <p>170364 Qty. 20 1.12 Watt. Base: T-1/4.</p>

809005 Wedge-Base Bulbs 12 V. II

 O.D. 2.5 mm 6.5 mm 25 mm 170972 Qty. 10 0.6 Watt. Base: T-3/4.	 O.D. 8.8 mm 27.8 mm 170751 Qty. 5 Halogen 3 Watt. Base: B 10d.	 170731 Qty. 10 Cover for Wddge-base bulbs 10.3 mm. Blue.	 170732 Qty. 10 Cover for Wddge-base bulbs 10.3 mm. Green.	 O.D. 3.4 mm 9 mm 170762 Qty. 5 14 V. 0.8 Watt.	 O.D. 5 mm 19.5 mm 170755 Qty. 5 0.5 Watt. Wedge base, plastic. T5 (W 2 x 4.6d).	 O.D. 10.3 mm 26.7 mm 170331 Qty. 10 3 Watt. Wedge base, T10 (W 2.1 x 9.5d).	 O.D. 10.3 mm 26.7 mm 170347 Qty. 10 5 Watt. Wedge base, T10 (W 2.1 x 9.5d).
 O.D. 4 mm 10.5 mm 26 mm 170364 Qty. 10 14 V. 1.12 Watt. Base: T-1/4.	 O.D. 5 mm 20 mm 170410 Qty. 10 1,12 Watt. Wedge base, T5 (W 2 x 4.6d).	 O.D. 5 mm 17.5 mm 170727 Qty. 5 1.12 Watt. Base: B 8.4d.	 O.D. 5 mm 20 mm 170617 Qty. 10 1.12 Watt. Frosted. Wedge base, T5 (W 2 x 4.6d).	 O.D. 5 mm 23.5 mm 170611 Qty. 10 2 Watt. Base: B 8.3d. (BAX 10 s.)	 O.D. 5 mm 20 mm 170758 Qty. 5 1.2 Watt. Wedge base, plastic. T5 (W 2 x 4.6d).	 O.D. 5 mm 23.5 mm 170357 Qty. 10 1.2 Watt. Base: 8.5d. (BAX 10d).	 O.D. 5 mm 23.5 mm 170545 Qty. 10 1.2 Watt. Base: 8.7d.
 O.D. 5 mm 23.5 mm 170610 Qty. 10 1.2 Watt. Base: 8.5d. (BAX 10d).	 O.D. 5 mm 12 mm 170753 Qty. 5 14 V. 1.4 Watt. Base: HRQ.	 O.D. 5 mm 17.5 mm 170756 Qty. 5 2 Watt. Base: 8.4d.	 O.D. 5 mm 23.5 mm 170612 Qty. 10 1.2 Watt. Base: 8.3d. (BAX 10s).	 O.D. 8.8 mm 27.8 mm 170752 Qty. 5 Halogen 5 Watt. Base: B 10d.	 O.D. 5 mm 21 mm 170698 Qty. 5 1.8 Watt. Alba-type. Base: EBS R11.	 O.D. 10.3 mm 26.7 mm 170754 Qty. 5 5 Watt. Amber. Wedge base, T10 (W 2.1 x 9.5d)..	 O.D. 7 mm 23 mm 170757 Qty. 5 14 V. 2 Watt. (1cp).













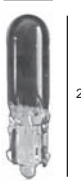

809009 Wedge Base Bulbs 12 V. - IV

 1.25 mm 17.5 mm 171033 Qty. 10 12 V. 1.2 Watt. Orange base. Base: B 8.4 d.	 O.D. 5 mm 1.25 mm 17.5 mm 171381 Qty. 10 12 V. 1.2 Watt. Blue base. Base: B 8.4 d.	 O.D. 5 mm 1.25 mm 17.5 mm 171023 Qty. 10 12 V. 1.5 Watt. Beige base. Base: B 8.4 d.	 O.D. 5 mm 1.25 mm 21 mm 171380 Qty. 10 12 V. 0.36 Watt. Purple base. Base: B 8.5 d. (BAX 10d).
 O.D. 5 mm 1.25 mm 21 mm 171379 Qty. 10 12 V. 1.0 Watt. Orange base. Base: B 8.5 d. (BAX 10 d).	 O.D. 5 mm 1.25 mm 21 mm 171024 Qty. 10 12 V. 1.2 Watt. Blue base. Base: B 8.2 d. (BAX 10 d).	 O.D. 5 mm 1.60 mm 21 mm 171383 Qty. 10 12 V. 1.5 Watt. Beige base. Base: B 8.5 d.	 O.D. 10 mm 28 mm 171387 Qty. 10 12 V. 2 Watt. White base. Base: B 12.3 d.
 O.D. 5 mm 21.5 mm 171284 Qty. 10 12 V. 1.2 Watt. Black base. Base: BX 2 d.	 O.D. 10 mm 46 mm 171385 Qty. 10 12 V. 2 cp. White base. Base: BX 84 d.	 O.D. 5 mm 20 mm 171031 Qty. 10 12 V. 1.2 Watt. Green base. Base: EBS R11.	 O.D. 3.5 mm 11 mm 171389 Qty. 10 14 V. 1.4 Watt. Black base. Base: T-1/4NW.
 O.D. 5 mm 38 mm 171382 Qty. 10 12 V. 1.2 Watt. Black base. Base: MFJZ.	 O.D. 5 mm 35 mm 171384 Qty. 10 12 V. 2 Watt. Black base. Base: MFJF.	 O.D. 7 mm 20 mm 171391 Qty. 10 12 V. 3 Watt. Green base. Wedge Base: T 7 (W 2 x 4.6d).	 O.D. 5 mm 20 mm 171388 Qty. 10 12 V. 0.4 Watt. Frosted. Grey base. Wedge base, plastic, T 5 (W 2 x 4.6 d).

O.E.M. names and numbers are used for reference purposes only.













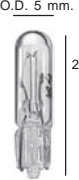
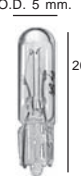

Wedge-Base Bulbs 12 V. III

809006



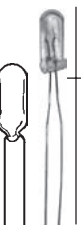

<p>O.D. 10.3 mm</p>  <p>26.7 mm</p> <p>170778 Qty. 10 3 Watt. Amber. Wedge base, T10 (W 2.1 x 9.5d).</p>	<p>O.D. 10.3 mm</p>  <p>26.7 mm</p> <p>170779 Qty. 10 3 Watt. Green. Wedge base, T10 (W 2.1 x 9.5d).</p>	<p>O.D. 10.3 mm</p>  <p>26.7 mm</p> <p>170780 Qty. 10 3 Watt. Blue. Wedge base, T10 (W 2.1 x 9.5d).</p>	<p>O.D. 10.3 mm</p>  <p>26.7 mm</p> <p>170781 Qty. 10 3 Watt. Red. Wedge base, T10 (W 2.1 x 9.5d).</p>	<p>O.D. 5 mm</p>  <p>20 mm</p> <p>170782 Qty. 10 1.2 Watt. Amber. Wedge base, T5 (W 2 x 4.6d).</p>	<p>O.D. 5 mm</p>  <p>20 mm</p> <p>170783 Qty. 10 1.2 Watt. Green. Wedge base, T5 (W 2 x 4.6d).</p>	<p>O.D. 5 mm</p>  <p>20 mm</p> <p>170784 Qty. 10 1.2 Watt. Blue. Wedge base, T5 (W 2 x 4.6d).</p>	<p>O.D. 5 mm</p>  <p>20 mm</p> <p>170785 Qty. 10 1.2 Watt. Red. Wedge base, T5 (W 2 x 4.6d).</p>
<p>O.D. 8.6 mm</p>  <p>27.4 mm</p> <p>170822 Qty. 5 4 Watt. Xenon blue. Brighter light as standard. Base: BA 9 s.</p>	<p>O.D. 10.3 mm</p>  <p>26.7 mm</p> <p>170948 Qty. 5 5 Watt. Xenon blue. Brighter light as standard. Wedge base, T10 (W 2.1 x 9.5d).</p>	<p>O.D. 10.3 mm</p>  <p>26.7 mm</p> <p>170725 Qty. 10 2 Watt. Wedge base, T10 (W 2.1 x 9.5d).</p>	<p>O.D. 10.3 mm</p>  <p>27.4 mm</p> <p>170786 Qty. 10 5 Watt. Base: B 12.9d.</p>	<p>O.D. 8.6 mm</p>  <p>23 mm</p> <p>170345 Qty. 10 2 Watt. Base: BA 9s.</p>	<p>O.D. 8.6 mm</p>  <p>23 mm</p> <p>170594 Qty. 10 3 Watt. Base: BA 9s.</p>	<p>O.D. 6.8 mm</p>  <p>20.7 mm</p> <p>170448 Qty. 10 2 Watt. Base: BA 7s.</p>	<p>O.D. 8.6 mm</p>  <p>27.4 mm</p> <p>170346 Qty. 20 4 Watt. Base: BA 9s.</p>

Wedge-Base Bulbs 12 - 24 V.

809007

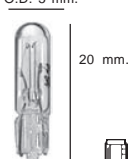
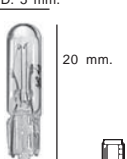
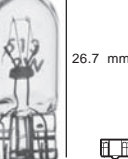
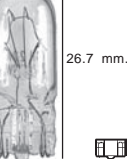
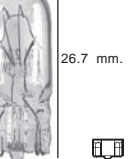
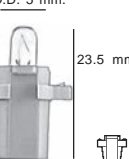
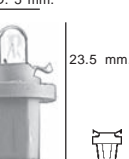
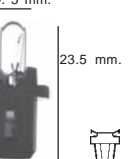
<p>O.D. 10.3 mm.</p>  <p>26.7 mm.</p> <p>170331 Qty. 10 12 V. 3 Watt. Wedge base, T10 (W 2.1 x 9.5d).</p>	<p>O.D. 10.3 mm.</p>  <p>26.7 mm.</p> <p>170476 Qty. 10 24 V. 3 Watt. Wedge base, T10 (W 2.1 x 9.5d).</p>	<p>O.D. 10.3 mm.</p>  <p>26.7 mm.</p> <p>170347 Qty. 10 12 V. 5 Watt. Wedge base, T10 (W 2.1 x 9.5d).</p>	<p>O.D. 10.3 mm.</p>  <p>26.7 mm.</p> <p>170542 Qty. 10 24 V. 5 Watt. Wedge base, T10 (W 2.1 x 9.5d).</p>	<p>O.D. 5 mm.</p>  <p>20 mm.</p> <p>170410 Qty. 10 12 V. 1.2 Watt. Wedge base, T5 (W 2 x 4.6d).</p>	<p>O.D. 5 mm.</p>  <p>20 mm.</p> <p>170617 Qty. 10 12 V. 1.2 Watt. Frosted. Wedge base, T5 (W 2 x 4.6d).</p>	<p>O.D. 5 mm.</p>  <p>20 mm.</p> <p>170477 Qty. 10 24 V. 1.2 Watt. Wedge base, T5 (W 2 x 4.6d).</p>	<p>O.D. 5 mm.</p>  <p>20 mm.</p> <p>170684 Qty. 10 24 V. 0.7 Watt. Wedge base, T5 (W 2 x 4.6d).</p>
<p>O.D. 5 mm.</p>  <p>23.5 mm.</p> <p>170612 Qty. 10 12 V. 1.2 Watt. Base: B 8.3d. (BAX 10s). Black Base.</p>	<p>O.D. 5 mm.</p>  <p>23.5 mm.</p> <p>170357 Qty. 10 12 V. 1.2 Watt. Base: B 8.5d. (BAX 10d). Black Base.</p>	<p>O.D. 5 mm.</p>  <p>23.5 mm.</p> <p>170613 Qty. 10 24 V. 1.2 Watt. Base: B 8.3d. (BAX 10s). Grey Base.</p>	<p>O.D. 5 mm.</p>  <p>23.5 mm.</p> <p>170545 Qty. 10 12 V. 1.2 Watt. Base: B 8.7d. Grey Base.</p>	<p>O.D. 5 mm.</p>  <p>23.5 mm.</p> <p>170358 Qty. 10 24 V. 1.2 Watt. Base: B 8.5d. (BAX 10d). Grey Base.</p>	<p>O.D. 5 mm.</p>  <p>23.5 mm.</p> <p>170611 Qty. 10 12 V. 2 Watt. Base: B 8.3d. (BAX 10s). White Base.</p>	<p>O.D. 5 mm.</p>  <p>23.5 mm.</p> <p>170610 Qty. 10 12 V. 2 Watt. Base: B 8.5d. (BAX 10d). Green Base.</p>	<p>O.D. 4 mm.</p>  <p>10.5 mm. 26 mm.</p> <p>170364 Qty. 10 14 V. 1.12 Watt. Base: T-1/4.</p>

809004 Wedge-Base Bulbs 24 V.

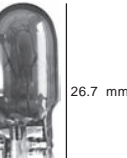
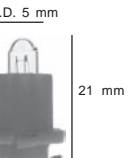
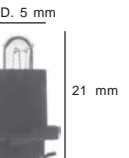
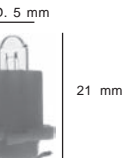
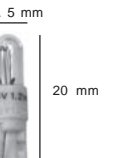
 <p>O.D. 5 mm. 20 mm.</p> <p>170684 Qty. 10 0.7 Watt. Wedge Base, T5 (W 2 x 4.6d).</p>	 <p>O.D. 5 mm. 20 mm.</p> <p>170477 Qty. 10 1.2 Watt. Wedge Base, T5 (W 2 x 4.6d).</p>	 <p>O.D. 10.3 mm. 26.7 mm.</p> <p>171027 Qty. 10 2 Watt. Wedge Base, T10 (W 2.1 x 9.5d).</p>	 <p>O.D. 10.3 mm. 26.7 mm.</p> <p>170476 Qty. 10 3 Watt. Wedge Base, T10 (W 2.1 x 9.5d).</p>	 <p>O.D. 10.3 mm. 26.7 mm.</p> <p>170542 Qty. 10 5 Watt. Wedge Base, T10 (W 2.1 x 9.5d).</p>	 <p>O.D. 5 mm. 23.5 mm.</p> <p>170613 Qty. 10 1.2 Watt. Grey Base: B 8.3 d. (BAX 10 s.)</p>	 <p>O.D. 5 mm. 23.5 mm.</p> <p>170358 Qty. 10 1.2 Watt. Grey Base: B 8.5 d. (BAX 10 d.)</p>	 <p>O.D. 5 mm. 23.5 mm.</p> <p>171028 Qty. 10 1.2 Watt. Brown Base: B 8.5 d. (BAX 10 d.)</p>
 <p>O.D. 10.3 mm. 26.7 mm.</p> <p>170808 Qty. 10 3 Watt. Red. Wedge Base, T10 (W 2.1 x 9.5d).</p>	 <p>O.D. 10.3 mm. 26.7 mm.</p> <p>170805 Qty. 10 3 Watt. Amber. Wedge Base, T10 (W 2.1 x 9.5d).</p>	 <p>O.D. 10.3 mm. 26.7 mm.</p> <p>170806 Qty. 10 3 Watt. Green. Wedge Base, T10 (W 2.1 x 9.5d).</p>	 <p>O.D. 10.3 mm. 26.7 mm.</p> <p>170807 Qty. 10 3 Watt. Blue. Wedge Base, T10 (W 2.1 x 9.5d).</p>	 <p>O.D. 5 mm 21 mm</p> <p>171025 Qty. 20 1.2 Watt. Yellow Base: EBS R11. Alba type.</p>	 <p>O.D. 5 mm 21 mm</p> <p>171026 Qty. 10 1.2 Watt. Brown Base: EBS R11. Alba type.</p>	 <p>O.D. 5 mm 21 mm</p> <p>171032 Qty. 10 1.4 Watt. Green Base: EBS R11. Alba type.</p>	 <p>O.D. 5 mm 20 mm</p> <p>171029 Qty. 10 1.2 Watt. White Wedge Base: plastic. T5 (W 2 x 4.6d).</p>

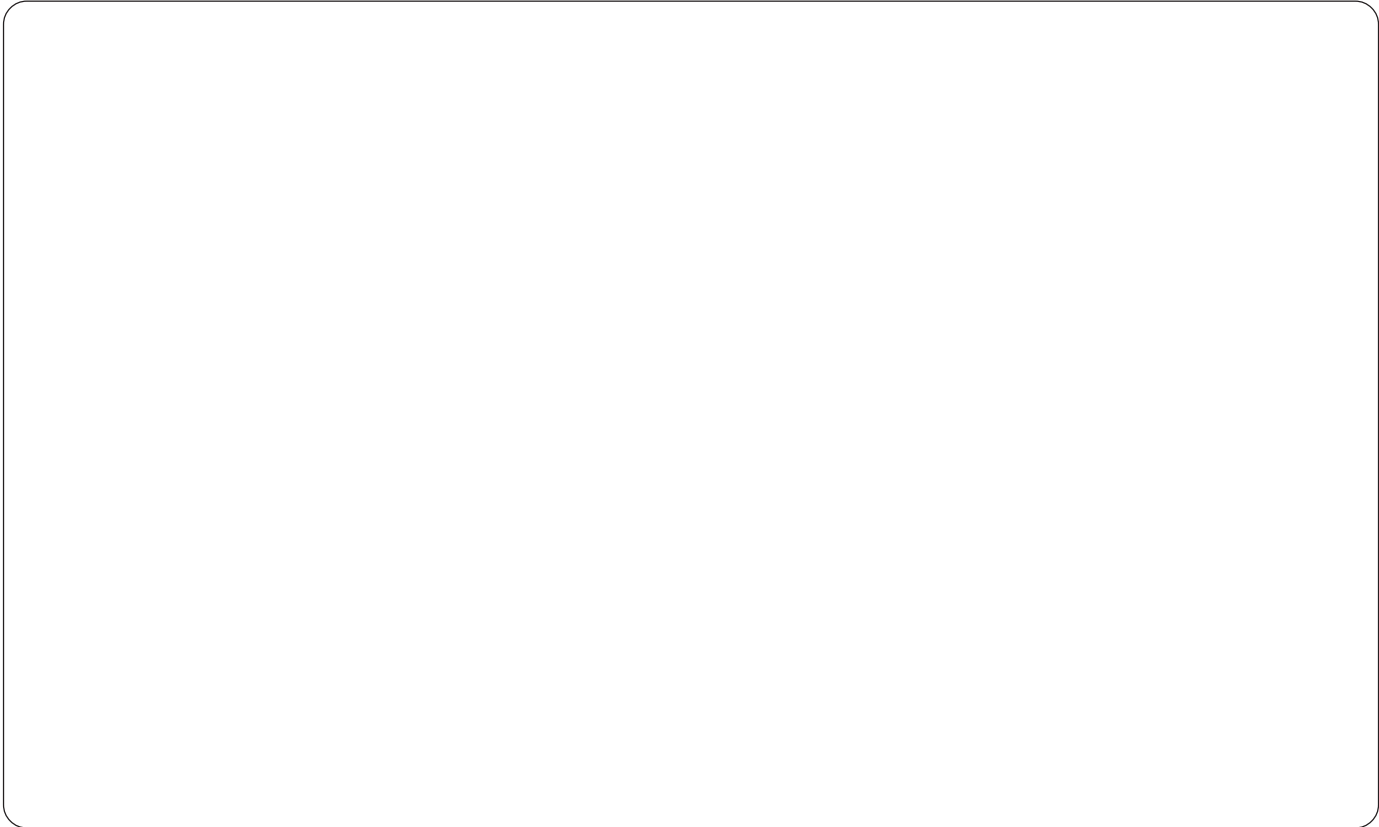
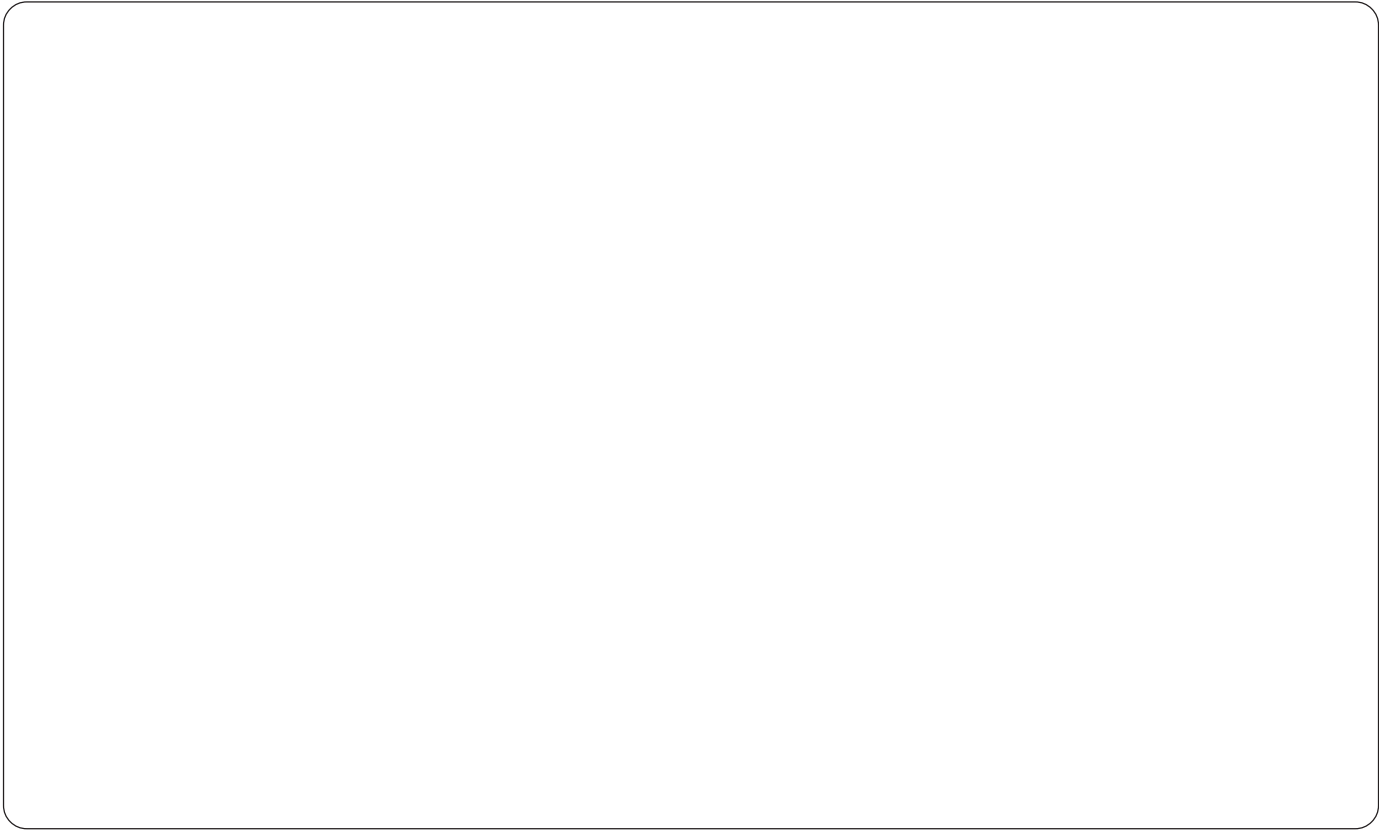















ASSORTMENTS

PART 10

Notes

A large, empty rectangular area with rounded corners, intended for taking notes. The area is completely blank and occupies most of the page below the header.

810001 Ignition Module - European Application









 <p>150055 Qty. 1 Repl. 0227 100 123. Serv. Alfa, BMW, Citroen, Mercedes, Peugeot. 7 terminals. Also replaces ignition modules w/ 6 terminals. Pick-up type.</p>	 <p>150056 Qty. 1 Repl. 0227 100 139. Serv. Alfa, Audi, BMW, Mercedes, Opel, Porsche. 7 terminals. Also replaces ignition modules w/ 6 terminals. Hall type.</p>	 <p>150057 Qty. 1 Repl. 1227 022 017. Serv. Citroen, Peugeot. 5 terminals. Pick-up type.</p>	 <p>150062 Qty. 1 Repl. D 1959, 16 017 433. Serv. AMC, Buick, Chevrolet, GM, Cadillac. 4 terminals. Pick-up type.</p>
 <p>150063 Qty. 1 Repl. D 1961. Serv. GM. 8 terminals. Pick-up type.</p>	 <p>150064 Qty. 1 Repl. D 1951, 7033103. Serv. Opel, Vauxhall. 6 terminals. Pick-up type.</p>	 <p>150384 Qty. 1 Repl. 30130-P06-006, E123-02, E123-03. Serv. Hoinda. 5 terminals. Amplifier.</p>	 <p>150098 Qty. 1 Repl. 0227 100 124. Serv. opel, Peugeot, Porsche, Saab, Volvo. 7 terminals. Also repl. ignition modules w/ 6 terminals. Amplifier.</p>
 <p>150088 Qty. 1 Repl. 9940096, 648 330 40, BKL4A. Serv. Fiat, Lancia. 5 terminals. Pick-up type.</p>	 <p>150075 Qty. 1 Repl. 0227 100 142, -143. Serv. Audi, VW. 7 terminals. Hall type.</p>	 <p>150071 Qty. 1 Repl. 1227 030 030. Serv. Audi, Seat, VW. 5 terminals. Amplifier.</p>	
 <p>150175 Qty. 1 Repl. 2108 373 4910-10. Serv. Lada. 7 terminals. Hall type.</p>			

810002 Ignition Module - Japanese Application

 <p>150234 Qty. 1 Repl. J17A, J00X01172. Serv. Mazda. 5 internal threaded terminals. Pick-up type.</p>	 <p>150068 Qty. 1 Repl. J106. Serv. Chrysler Mazda, Mitsubishi. 4 terminals. Pick-up type.</p>	 <p>150091 Qty. 1 Repl. 94243344, 32120-PA0-664. Serv. GM, Honda, Isuzu, Nissan. 2 screw terminals. Pick-up type.</p>	 <p>150096 Qty. 1 Repl. J152. Serv. Mitsubishi, Chrysler, Hyundai, Mazda. 2 terminals. Pick-up type.</p>
 <p>150157 Qty. 1 Repl. 131300-0033, 0072. Serv. Toyota. 3 screw terminals. Pick-up type.</p>	 <p>150160 Qty. 1 Repl. J117. Serv. Ford, Mazda, Nissan, Suzuki. 4 terminals. Pick-up type.</p>	 <p>150235 Qty. 1 Repl. j208, MD607 409. Serv. Mazda. 6 terminals. Pick-up type.</p>	 <p>150236 Qty. 1 Repl. MNE-301, -302, 30120-PM5-A01. Serv. Honda. 5 terminals. Amplifier.</p>
 <p>150377 Qty. 1 Repl. J121, MD611384. Serv. Hyundai, Suzuki. 3 terminals. Amplifier.</p>	 <p>150398 Qty. 1 Repl. 30120 PM3 005. Serv. Hitachi, Honda. 5 terminals. Pick-up type.</p>	 <p>150168 Qty. 1 Repl. 86FB 12A297AA, 6153090. Serv. Ford Escort, Scorpio, Sierra. 7 terminals. Amplifier.</p>	
 <p>150378 Qty. 1 Repl. J153, MD618293. Serv. Mitsubishi. 5 screw terminals. Amplifier.</p>			



Pick-Up Coils

810006

 <p>150308 Qty. 1 PICK-UP, HALL. Serv. Volvo.</p>	 <p>150323 Qty. 1 PICK-UP COIL. Serv. Opel, Vauxhall. 800 Ohm.</p>	 <p>150324 Qty. 1 PICK-UP COIL. Serv. Opel, Vauxhall. 800 Ohm.</p>	 <p>150150 Qty. 1 PICK-UP COIL. Serv. Fiat, Lancia. 750 - 915 Ohm. Wire 95 mm.</p>
 <p>150402 Qty. 1 PICK-UP, HALL. Serv. Volvo. W/o terminals.</p>	 <p>150321 Qty. 1 PICK-UP, HALL. Serv. Hyundai, Saab.</p>	 <p>150109 Qty. 1 PICK-UP, HALL. Serv. Opel, Vauxhall.</p>	 <p>150124 Qty. 1 PICK-UP ONLY, HALL. Serv. Fiat, Saab, VW. Goes w/ diaphragm: Cargo 150109.</p>
 <p>150309 Qty. 1 PICK-UP, HALL. Serv. VW.</p>			

Timing Sensors

810007

 <p>150336 Qty. 1 Serv. Volvo. 170 Ohm. L¹ 22.2 mm. L. 510 mm.</p>	 <p>150340 Qty. 1 Serv. Volvo. 240 Ohm. L¹ 24 mm. L. 240 mm.</p>	 <p>150404 Qty. 1 Serv. Renault. 250 Ohm. L¹ 24 mm.</p>	 <p>150366 Qty. 1 Serv. Citroen, Peugeot. 370 Ohm. L¹ 24 mm. L. 340 mm.</p>
 <p>150343 Qty. 1 Serv. Citroen, Fiat, Peugeot. 370 Ohm. L¹ 24 mm. L. 340 mm.</p>	 <p>150361 Qty. 1 Serv. Opel, Saab, Vauxhall. 530 Ohm. L¹ 24 mm. L. 995 mm.</p>	 <p>150354 Qty. 1 Serv. Fiat. 530 Ohm. L¹ 34.5 mm. L. 615 mm.</p>	 <p>150332 Qty. 1 Serv. Fiat, Lancia. 780 Ohm. L¹ 13.5 mm. L. 465 mm.</p>















ASSORTMENTS

PART 11

























Notes

A large, empty rectangular area with rounded corners, intended for taking notes. The area is completely blank and occupies most of the page's vertical space.

8 1 1 0 0 1 **Mini Relays 12 V.**













 <p>160080 Qty. 6 30 Amp. 4 terminals.</p>	 <p>160282 Qty. 6 As Cargo 160311, but w/o bracket 40 Amp. 4 terminals.</p>	 <p>160081 Qty. 6 20/30 Amp. 5 terminals.</p>	 <p>160308 Qty. 6 W/o bracket 15/40 Amp. 5 terminals.</p>
 <p>160155 Qty. 2 15 Amp. 4 terminals. W/ insertable blade fuse.</p>	 <p>160083 Qty. 2 30 Amp. 4 terminals.</p>	 <p>160265 Qty. 2 30 Amp. 5 terminals.</p>	 <p>160468 Qty. 2 12 V. 70 Amp. 4 terminals W/ two 6.3 mm. ans two 9.5 mm. terminals. (Terminals 30 and 87). W/o Bracket, w/ resistor.</p>
 <p>160239 Qty. 2 70 Amp. 4 terminals. W/ two 6.3 and 9.5 mm. contacts. (Terminals 30 and 87.)</p>	 <p>160168 Qty. 2 2 x 15 Amp. 5 terminals.</p>	 <p>160270 Qty. 2 20/30 Amp. 5 terminals. W/ diode.</p>	 <p>160403 Qty. 2 12 V. 20/30 Amp. 5 terminals. W/ resistor.</p>

8 1 1 0 0 2 **Mini Relays 12 - 24 V.**

 <p>160155 Qty. 1 12 V. 15 Amp. 4 terminals. W/ insertable blade fuse.</p>	 <p>160473 Qty. 1 24 V. 15 Amp. 4 terminals. W/ insertable ATO blade fuse.</p>	 <p>160080 Qty. 1 12 V. 30 Amp. 4 terminals.</p>	 <p>160311 Qty. 1 12 V. 40 Amp. 4 terminals.</p>	 <p>160082 Qty. 1 24 V. 20 Amp. 4 terminals.</p>	 <p>160307 Qty. 1 As Cargo 160082, but w/o bracket. 24 V. 20 Amp. 4 terminals.</p>
 <p>160282 Qty. 1 As Cargo 160311, but w/o bracket. 12 V. 40 Amp. 4 terminals</p>	 <p>160083 Qty. 1 12 V. 30 Amp. 4 terminals.</p>	 <p>160215 Qty. 1 12 V. 20 Amp. 4 terminals.</p>	 <p>160265 Qty. 1 12 V. 30 Amp. 5 terminals.</p>	 <p>160266 Qty. 1 24 V. 20 Amp. 5 terminals.</p>	 <p>160239 Qty. 1 12 V. 70 Amp. 4 terminals.</p>
 <p>160272 Qty. 1 24 V. 70 Amp. 4 terminals. W/o bracket, w/ resistor.</p>	 <p>160168 Qty. 1 12 V. 2 x 15 Amp. 5 terminals.</p>	 <p>160169 Qty. 1 24 V. 2 x 10 Amp. 5 terminals.</p>	 <p>160081 Qty. 1 12 V. 20/30 Amp. 5 terminals.</p>	 <p>160270 Qty. 1 12 V. 20/30 Amp. 5 terminals. W/ diode.</p>	 <p>160216 Qty. 1 24 V. 10/20 Amp. 5 terminals.</p>
 <p>160479 Qty. 1 12 V. 25 Amp. 3 terminals. W/ bracket.</p>	 <p>160480 Qty. 1 12 V. 25 Amp. 4 terminals. W/ bracket.</p>	 <p>160316 Qty. 1 12 V. 15/40 Amp. 5 terminals.</p>	 <p>160317 Qty. 1 24 V. 10/22 Amp. 5 terminals.</p>		

Mini Relays 24 V.

811003















 <p>160082 Qty. 4 20 Amp. 4 terminals.</p>	 <p>160307 Qty. 4 As Cargo 160082, but w/o bracket. 20 Amp. 4 terminals.</p>	 <p>160215 Qty. 4 20 Amp. 4 terminals.</p>	 <p>160216 Qty. 4 10/20 Amp. 5 terminals.</p>
 <p>160337 Qty. 2 10/22 Amp. 5 terminals. W/o bracket.</p>	 <p>160266 Qty. 2 20 Amp. 5 terminals.</p>	 <p>160240 Qty. 2 40 Amp. 4 terminals. W/ two 6.3 and 9.5 mm. contacts. (Terminals 30 and 87.)</p>	 <p>160272 Qty. 2 70 Amp. 4 terminals. W/ two 6.3 and 9.5 mm. contacts. (Terminals 30 and 87.) W/o bracket, w/ resistor.</p>
 <p>160169 Qty. 2 2 x 10 Amp. 5 terminals.</p>	 <p>160268 Qty. 1 2 x 20 Amp. 2 x 4 terminals.</p>	 <p>160271 Qty. 2 10/20 Amp. 5 terminals. W/ diode.</p>	 <p>160317 Qty. 2 10/20 Amp. 5 terminals.</p>

Micro Relays

811004

 <p>160363 Qty. 2 12 V. 25 Amp. 4 terminals. W/o bracket.</p>	 <p>160364 Qty. 2 12 V. 25 Amp. W/ diode. W/o bracket.</p>	 <p>160365 Qty. 2 12 V. 10/20 Amp. 5 terminals. W/o bracket.</p>	 <p>160366 Qty. 2 12 V. 15/25 Amp. 5 terminals. W/ diode. W/o bracket.</p>
 <p>160367 Qty. 2 12 V. 15/25 Amp. 5 terminals. W/ resistor. W/o bracket.</p>	 <p>191752 Qty. 10 Socket for micro relay. 5 terminals max. Sockets can be build together. 2 x 6.3 mm. flat plug terminal. 3 x 4.7 mm. flat plug terminal.</p>	 <p>160368 Qty. 2 24 V. 4/10 Amp. 5 terminals. W/o bracket.</p>	 <p>190252 Qty. 100 6.3 mm. 1.0 - 2.5 mm². W/ non-return tag. Female type. Flat plug connector. For multiple connectors.</p>  <p>191089 Qty. 100 4.7 mm. 0.5 - 1.0 mm². W/ non-return tag. Female type. Flat plug connector. For multiple connectors.</p>

811005 Flasher Units 12 V.

<p>160115 Qty. 1 138 Watt. 2 terminals.</p> 	<p>160116 Qty. 1 138 Watt. 3 terminals.</p> 	<p>160242 Qty. 1 2/4 x 21 Watt. 3 terminals. Serv. Alfa Romeo, Audi, BMW, Ford, Opel.</p> 	<p>160315 Qty. 1 2/4 x 21 Watt. 3 terminals. Serv. Japanese vehicles.</p> 																																				
<p>160312 Qty. 1 2/4 x 21 Watt. 3 terminals. Interchangeable w/ any 4 terminal device (+, -, C, R). For SAE standard vehicles.</p> 	<p>160243 Qty. 1 2/4 x 21 Watt. 4 terminals. For vehicles towing trailers or caravans. Serv. Alfa Romeo, Citroen, Fiat, Ford, Lada.</p> 	<p>160244 Qty. 1 2+1/6 x 21 Watt. 4 terminals. For vehicles towing trailers or caravans. Serv. Audi, BMW, Fiat, Ford, Jap. vehicles.</p> 	<p>160402 Qty. 1 2+1/6 x 21 Watt. 4 terminals +2 in top. For vehicles towing trailers or caravans.</p> 																																				
<p>160474 Qty. 1 2/4 x 21 Watt. 3 terminals. Serv. VW.</p> 	<p>160305 Qty. 1 2+1/6 x 21 Watt. 4 bullet terminals. For vehicles towing trailers or caravans. Serv. Mercedes.</p> 	<p>160314 Qty. 1 2+1/6 x 21 Watt. 5 terminals. For vehicles towing trailers or caravans. For SAE standard vehicles.</p> 	<p>Terminal Designations</p> <table border="1"> <thead> <tr> <th></th> <th>(D)</th> <th>(F)</th> <th>(J)</th> <th>(US)</th> <th>(GB)</th> </tr> </thead> <tbody> <tr> <td></td> <td>+49</td> <td>+</td> <td>B</td> <td>X / B</td> <td></td> </tr> <tr> <td></td> <td>49a</td> <td>C</td> <td>L</td> <td>L</td> <td></td> </tr> <tr> <td></td> <td>C</td> <td>R</td> <td></td> <td>P</td> <td></td> </tr> <tr> <td></td> <td>31</td> <td>-</td> <td>E</td> <td>Ground</td> <td></td> </tr> <tr> <td></td> <td>C2</td> <td>R2</td> <td></td> <td>C2</td> <td></td> </tr> </tbody> </table>		(D)	(F)	(J)	(US)	(GB)		+49	+	B	X / B			49a	C	L	L			C	R		P			31	-	E	Ground			C2	R2		C2	
	(D)	(F)		(J)	(US)	(GB)																																	
	+49	+		B	X / B																																		
	49a	C	L	L																																			
	C	R		P																																			
	31	-	E	Ground																																			
	C2	R2		C2																																			
<p>160475 Qty. 1 2+1/6 x 21 Watt. 4 terminals +2 in top. For vehicles towing trailers or caravans.</p> 	<p>160263 Qty. 1 2+1+1/8 x 21 Watt. 6 terminals. Serv. John Deere, Fendt, IH Case etc.</p> 	<p>160341 Qty. 1 180 Watt. 3 terminals. 16 Amp.</p> 																																					

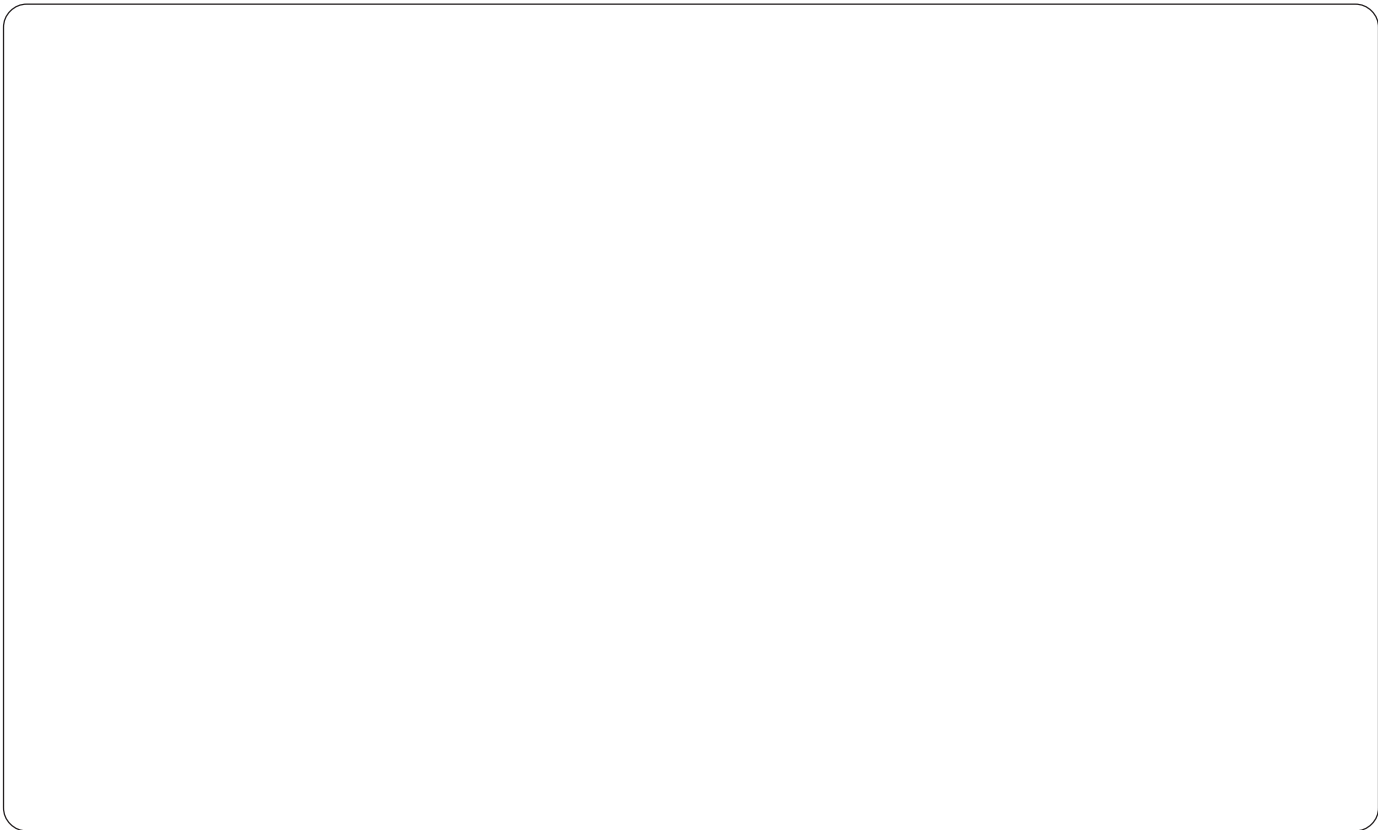
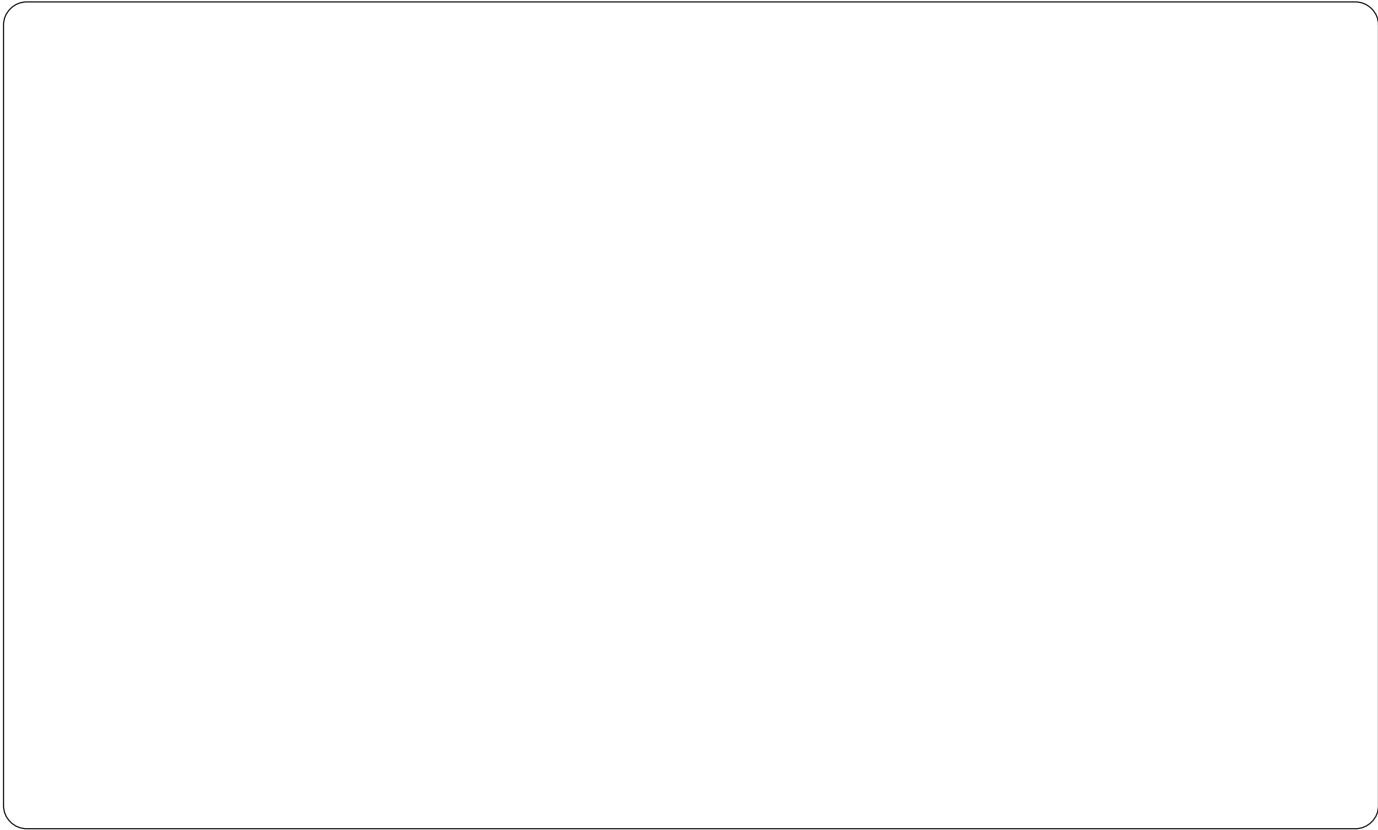



ASSORTMENTS

PART 15

Notes

815001 Servicing Alfa Romeo

 250439 Qty. 10 I.D. 4.47 mm. Th. 1.78 mm. O-ring.	 250452 Qty. 10 I.D. 6.04 mm. Th. 1.78 mm. O-ring.	 250455 Qty. 10 I.D. 6.73 mm. Th. 1.63 mm. O-ring.	 250454 Qty. 10 I.D. 6.80 mm. Th. 1.78 mm. O-ring.	 250440 Qty. 10 I.D. 7.65 mm. Th. 1.78 mm. O-ring.	 250453 Qty. 10 I.D. 9.25 mm. Th. 1.78 mm. O-ring.	 250345 Qty. 1 384 ml. Oil Lubricant.
 250456 Qty. 10 I.D. 10.0 mm. Th. 2.5 mm. O-ring.	 250441 Qty. 10 I.D. 10.82 mm. Th. 1.78 mm. O-ring.	 250457 Qty. 10 I.D. 13.95 mm. Th. 2.62 mm. O-ring.	 250442 Qty. 10 I.D. 14.0 mm. Th. 1.78 mm. O-ring.	 250152 Qty. 10 I.D. 15.54 mm. Th. 2.62 mm. O-ring.	 250443 Qty. 10 I.D. 17.17 mm. Th. 1.78 mm. O-ring.	
 250459 Qty. 10 I.D. 18.72 mm. Th. 2.62 mm. O-ring.	 250528 Qty. 10 R12 1R134A. Standard flow. Valve core.		 250523 Qty. 6 13 mm. low side. Shipping cap.			
 250134 Qty. 10 I.D. 20.22 mm. Th. 3.53 mm. O-ring.	 250181 Qty. 10 Serv. SD709. Shipping cap.	 250525 Qty. 6 16 mm. high side. Shipping cap.	 250525 Qty. 6 16 mm. high side. Shipping cap.			

















815002 Servicing Audi / VW

 250439 Qty. 10 I.D. 4.47 mm. Th. 1.78 mm. O-ring.	 250440 Qty. 10 I.D. 6.65 mm. Th. 2.0 mm. O-ring.	 250444 Qty. 10 I.D. 8.0 mm. Th. 2.0 mm. O-ring.	 250086 Qty. 10 Servicing SD. I.D. 8.92 mm. Th. 1.83 mm. O-ring.	 250441 Qty. 10 I.D. 10.82 mm. Th. 1.78 mm. O-ring.	 250442 Qty. 10 I.D. 14.0 mm. Th. 1.78 mm. O-ring.	 250345 Qty. 1 384 ml. Oil Lubricant.
 250445 Qty. 10 I.D. 14.3 mm. Th. 2.3 mm. O-ring.	 250446 Qty. 10 I.D. 16.0 mm. Th. 1.78 mm. O-ring.	 250447 Qty. 10 I.D. 16.5 mm. Th. 2.43 mm. O-ring.	 250448 Qty. 10 I.D. 17.0 mm. Th. 2.0 mm. O-ring.	 250443 Qty. 10 I.D. 17.17 mm. Th. 1.78 mm. O-ring.	 250134 Qty. 10 I.D. 20.22 mm. Th. 3.53 mm. O-ring.	
 250449 Qty. 10 I.D. 20.35 mm. Th. 1.78 mm. O-ring.	 250450 Qty. 10 I.D. 23.47 mm. Th. 1.78 mm. O-ring.	 250181 Qty. 6 Servicing SD709. Shipping cap.	 250526 Qty. 4 13 mm. low side. Shipping cap.	 250522 Qty. 4 13 mm. low side. Shipping cap.		
 250528 Qty. 10 R12 1R134A. Standard flow. Valve core.	 250529 Qty. 10 R134A JRA. High flow. Valve core.	 250527 Qty. 4 16 mm. high side. Shipping cap.	 250524 Qty. 4 16 mm. high side. Shipping cap.			

O.E.M. names and numbers are used for reference purposes only.

Servicing BMW

815003

 <p>250002 Qty. 4 Servicing 10PA15, -17, -20. Manifold Seal.</p>		 <p>250514 Qty. 4 Servicing 10PA. Manifold Seal.</p>		 <p>250181 Qty. 6 Servicing SD709. Shipping cap.</p>	 <p>250523 Qty. 6 13 mm. low side. Shipping cap.</p>	 <p>250345 Qty. 1 384 ml. Oil Lubricant.</p>
 <p>250525 Qty. 6 16 mm. high side. Shipping cap.</p>						
 <p>250460 Qty. 10 I.D. 6.07 mm. Th. 1.63 mm. O-ring.</p>	 <p>250440 Qty. 10 I.D. 7.65 mm. Th. 1.78 mm. O-ring.</p>	 <p>250462 Qty. 10 I.D. 9.19 mm. Th. 2.62 mm. O-ring.</p>	 <p>250453 Qty. 10 I.D. 9.25 mm. Th. 1.78 mm. O-ring.</p>	 <p>250463 Qty. 10 I.D. 10.77 mm. Th. 2.62 mm. O-ring.</p>	 <p>250441 Qty. 10 I.D. 10.82 mm. Th. 1.78 mm. O-ring.</p>	
 <p>250442 Qty. 10 I.D. 14.0 mm. Th. 1.78 mm. O-ring.</p>	 <p>250461 Qty. 10 I.D. 14.0 mm. Th. 2.5 mm. O-ring.</p>	 <p>250152 Qty. 10 I.D. 15.54 mm. Th. 2.62 mm. O-ring.</p>	 <p>250443 Qty. 10 I.D. 14.0 mm. Th. 1.78 mm. O-ring.</p>	 <p>250450 Qty. 10 I.D. 23.47 mm. Th. 2.62 mm. O-ring.</p>	 <p>250528 Qty. 10 R12 1R134A. Standard flow. Valve core.</p>	

Servicing Citroën / Peugeot

815004

 <p>250439 Qty. 10 I.D. 4.47 mm. Th. 1.78 mm. O-ring.</p>	 <p>250440 Qty. 10 I.D. 7.65 mm. Th. 1.78 mm. O-ring.</p>	 <p>250086 Qty. 10 I.D. 8.92 mm. Th. 1.83 mm. O-ring.</p>	 <p>250345 Qty. 1 384 ml. Oil Lubricant.</p>
 <p>250441 Qty. 10 I.D. 10.82 mm. Th. 1.78 mm. O-ring.</p>	 <p>250442 Qty. 10 I.D. 14.0 mm. Th. 1.78 mm. O-ring.</p>	 <p>250443 Qty. 10 I.D. 17.17 mm. Th. 1.78 mm. O-ring.</p>	
 <p>250528 Qty. 10 R12 1R134A. Standard flow. Valve core.</p>	 <p>250531 Qty. 5 R124A M8. High flow. Valve core.</p>	 <p>250134 Qty. 10 I.D. 20.22 mm. Th. 3.53 mm. O-ring.</p>	
 <p>250181 Qty. 10 Servicing SD709. Shipping cap.</p>	 <p>250523 Qty. 6 13 mm. low side. Shipping cap.</p>	 <p>250525 Qty. 6 16 mm. high side. Shipping cap.</p>	

815005 Servicing Fiat

 250439 Qty. 10 I.D. 4.47 mm. Th. 1.78 mm. O-ring.	 250454 Qty. 10 I.D. 6.80 mm. Th. 1.87 mm. O-ring.	 250438 Qty. 10 I.D. 7.00 mm. Th. 1.50 mm. O-ring.	 250440 Qty. 10 I.D. 7.65 mm. Th. 1.78 mm. O-ring.	 250444 Qty. 10 I.D. 8.0 mm. Th. 2.0 mm. O-ring.	 250453 Qty. 10 I.D. 9.25 mm. Th. 1.78 mm. O-ring.	 250345 Qty. 1 384 ml. Oil Lubricant.
 250441 Qty. 10 I.D. 10.82 mm. Th. 1.78 mm. O-ring.	 250467 Qty. 10 I.D. 12.93 mm. Th. 1.85 mm. O-ring.	 250442 Qty. 10 I.D. 14.0 mm. Th. 1.78 mm. O-ring.	 250152 Qty. 10 I.D. 15.54 mm. Th. 2.62 mm. O-ring.	 250474 Qty. 10 I.D. 17.12 mm. Th. 2.62 mm. O-ring.	 250443 Qty. 10 I.D. 17.17 mm. Th. 1.78 mm. O-ring.	
 250459 Qty. 10 I.D. 18.72 mm. Th. 2.62 mm. O-ring.	 250528 Qty. 10 R12 1R134A. Standard flow. Valve core.		 250522 Qty. 5 13 mm. low side. Shipping cap.			
 250477 Qty. 10 I.D. 20.29 mm. Th. 2.62 mm. O-ring.	 250181 Qty. 10 Servicing SD709. Shipping cap.		 250524 Qty. 5 16 mm. high side. Shipping cap.			

815006 Servicing Ford I

 250439 Qty. 10 I.D. 4.47 mm. Th. 1.78 mm. O-ring.	 250452 Qty. 10 I.D. 6.04 mm. Th. 1.78 mm. O-ring.	 250454 Qty. 10 I.D. 6.80 mm. Th. 1.87 mm. O-ring.	 250465 Qty. 10 I.D. 7.38 mm. Th. 1.81 mm. O-ring.	 250469 Qty. 10 I.D. 7.65 mm. Th. 1.63 mm. O-ring.	 250440 Qty. 10 I.D. 7.65 mm. Th. 1.78 mm. O-ring.	 250345 Qty. 1 384 ml. Oil Lubricant.
 250444 Qty. 10 I.D. 8.00 mm. Th. 2.00 mm. O-ring.	 250462 Qty. 10 I.D. 9.19 mm. Th. 2.62 mm. O-ring.	 250453 Qty. 10 I.D. 9.25 mm. Th. 1.78 mm. O-ring.	 250456 Qty. 10 I.D. 10.00 mm. Th. 2.50 mm. O-ring.	 250464 Qty. 10 I.D. 10.12 mm. Th. 1.85 mm. O-ring.	 250441 Qty. 10 I.D. 10.82 mm. Th. 1.78 mm. O-ring.	
 250467 Qty. 10 I.D. 12.93 mm. Th. 1.85 mm. O-ring.	 250466 Qty. 10 I.D. 13.10 mm. Th. 1.60 mm. O-ring.		 250442 Qty. 10 I.D. 14.0 mm. Th. 1.78 mm. O-ring.			
 250468 Qty. 10 I.D. 15.68 mm. Th. 1.93 mm. O-ring.	 250443 Qty. 10 I.D. 17.17 mm. Th. 1.78 mm. O-ring.		 250470 Qty. 10 I.D. 19.18 mm. Th. 2.46 mm. O-ring.			

O.E.M. names and numbers are used for reference purposes only.

Servicing Ford II

815007

 250443 Qty. 10 I.D. 17.17 mm. Th. 1.78 mm. O-ring.	 250472 Qty. 10 I.D. 20.00 mm. Th. 2.4 mm. O-ring.	 250134 Qty. 10 I.D. 22.22 mm. Th. 3.53 mm. O-ring.	 250528 Qty. 10 R12 1R134A. Standard flow. Valve core.	 250529 Qty. 10 R134A JRA. High flow. Valve core.
 250181 Qty. 10 Serv. DS709. Shipping cap.	 250526 Qty. 6 13 mm. low side. Shipping cap.	 250527 Qty. 6 16 mm. high side. Shipping cap.	 250345 Qty. 1 384 ml. Oil Lubricant.	
 250537 Qty. 10 MC-590. Springlock.	 250536 Qty. 10 MC-594. Springlock.	 250523 Qty. 6 13 mm. low side. Shipping cap.		
 250539 Qty. 10 MC-595. Springlock.	 250538 Qty. 10 MC-592. Springlock.	 250525 Qty. 6 16 mm. high side. Shipping cap.		

Servicing Honda / Acura

815008

 250002 Qty. 2 Serv. 10PA15, -17, -20. Manifold seal.	 250439 Qty. 10 I.D. 4.47 mm. Th. 1.78 mm. O-ring.	 250484 Qty. 10 I.D. 4.70 mm. Th. 1.42 mm. O-ring.	 250473 Qty. 5 I.D. 6.60 mm. Th. 2.00 mm. O-ring.	 250438 Qty. 10 I.D. 7.00 mm. Th. 1.50 mm. O-ring.	 250453 Qty. 10 I.D. 9.25 mm. Th. 1.78 mm. O-ring.	 250463 Qty. 4 I.D. 10.77 mm. Th. 2.62 mm. O-ring.		
	 250471 Qty. 4 I.D. 11.00 mm. Th. 2.50 mm. O-ring.	 250486 Qty. 4 I.D. 13.00 mm. Th. 2.50 mm. O-ring.	 250475 Qty. 4 I.D. 13.46 mm. Th. 2.46 mm. O-ring.	 250442 Qty. 10 I.D. 14.00 mm. Th. 1.78 mm. O-ring.	 250345 Qty. 1 384 ml. Oil Lubricant.			
 250152 Qty. 4 I.D. 15.54 mm. Th. 2.62 mm. O-ring.	 250474 Qty. 4 I.D. 17.12 mm. Th. 2.62 mm. O-ring.	 250443 Qty. 10 I.D. 17.17 mm. Th. 1.78 mm. O-ring.	 250459 Qty. 4 I.D. 18.72 mm. Th. 2.62 mm. O-ring.	 250470 Qty. 4 I.D. 19.18 mm. Th. 2.46 mm. O-ring.				 250477 Qty. 4 I.D. 20.29 mm. Th. 2.62 mm. O-ring.
 250528 Qty. 2 R12 1R134A. Standard flow. Valve core.	 250529 Qty. 2 R134A JRA. High flow. Valve core.	 250526 Qty. 2 13 mm. low side. Shipping cap.	 250527 Qty. 2 16 mm. high side. Shipping cap.	 250522 Qty. 2 13 mm. low side. Shipping cap.				 250525 Qty. 2 16 mm. high side. Shipping cap.

815009 Servicing Hyundai

 250487 Qty. 4 I.D. 2.88 mm. Th. 1.77 mm. O-ring.	 250439 Qty. 10 I.D. 4.47 mm. Th. 1.78 mm. O-ring.	 250469 Qty. 10 I.D. 7.65 mm. Th. 1.63 mm. O-ring.	 250440 Qty. 10 I.D. 7.65 mm. Th. 1.78 mm. O-ring.	 250444 Qty. 10 I.D. 8.0 mm. Th. 2.0 mm. O-ring.	 250453 Qty. 10 I.D. 9.25 mm. Th. 1.78 mm. O-ring.	 250345 Qty. 1 384 ml. Oil Lubricant.
 250441 Qty. 10 I.D. 10.82 mm. Th. 1.78 mm. O-ring.	 250467 Qty. 4 I.D. 12.93 mm. Th. 1.85 mm. O-ring.	 250442 Qty. 10 I.D. 14.0 mm. Th. 1.78 mm. O-ring.	 250152 Qty. 4 I.D. 15.54 mm. Th. 2.62 mm. O-ring.	 250468 Qty. 4 I.D. 15.68 mm. Th. 1.93 mm. O-ring.	 250474 Qty. 4 I.D. 17.12 mm. Th. 2.62 mm. O-ring.	
 250443 Qty. 10 I.D. 17.17 mm. Th. 1.78 mm. O-ring.	 250481 Qty. 4 I.D. 17.80 mm. Th. 2.40 mm. O-ring.	 250536 Qty. 2 MC-594. Springlock.	 250528 Qty. 2 R12 1R134A. Standard flow. Valve core.	 250522 Qty. 2 13 mm. low side. Shipping cap.	 250526 Qty. 2 13 mm. low side. Shipping cap.	
 250459 Qty. 4 I.D. 18.72 mm. Th. 2.62 mm. O-ring.	 250134 Qty. 4 I.D. 20.22 mm. Th. 1.85 mm. O-ring.	 250538 Qty. 2 MC-592. Springlock.	 250529 Qty. 2 R134A JRA. High flow. Valve core.	 250524 Qty. 2 16 mm. high side. Shipping cap.	 250527 Qty. 2 16 mm. high side. Shipping cap.	

815010 Servicing Mazda

 250439 Qty. 10 I.D. 4.47 mm. Th. 1.78 mm. O-ring.	 250473 Qty. 10 I.D. 6.60 mm. Th. 2.00 mm. O-ring.	 250465 Qty. 5 I.D. 7.38 mm. Th. 1.81 mm. O-ring.	 250440 Qty. 10 I.D. 7.65 mm. Th. 1.78 mm. O-ring.	 250444 Qty. 10 I.D. 8.0 mm. Th. 2.0 mm. O-ring.	 250464 Qty. 5 I.D. 10.12 mm. Th. 1.85 mm. O-ring.	 250441 Qty. 10 I.D. 10.82 mm. Th. 1.78 mm. O-ring.	 250467 Qty. 5 I.D. 12.93 mm. Th. 1.85 mm. O-ring.	 250345 Qty. 1 384 ml. Oil Lubricant.
 250460 Qty. 4 I.D. 6.07 mm. Th. 1.63 mm. O-ring.	 250438 Qty. 10 I.D. 7.00 mm. Th. 1.50 mm. O-ring.	 250469 Qty. 10 I.D. 7.65 mm. Th. 1.63 mm. O-ring.	 250440 Qty. 10 I.D. 7.65 mm. Th. 1.78 mm. O-ring.	 250444 Qty. 10 I.D. 8.0 mm. Th. 2.0 mm. O-ring.	 250464 Qty. 5 I.D. 10.12 mm. Th. 1.85 mm. O-ring.	 250441 Qty. 10 I.D. 10.82 mm. Th. 1.78 mm. O-ring.	 250467 Qty. 5 I.D. 12.93 mm. Th. 1.85 mm. O-ring.	
 250442 Qty. 10 I.D. 14.00 mm. Th. 1.78 mm. O-ring.	 250152 Qty. 4 I.D. 15.54 mm. Th. 2.62 mm. O-ring.	 250468 Qty. 5 I.D. 15.68 mm. Th. 1.93 mm. O-ring.	 250474 Qty. 4 I.D. 17.12 mm. Th. 2.62 mm. O-ring.	 250443 Qty. 10 I.D. 17.17 mm. Th. 1.78 mm. O-ring.	 250459 Qty. 4 I.D. 18.72 mm. Th. 2.62 mm. O-ring.			
 250470 Qty. 4 I.D. 19.18 mm. Th. 2.46 mm. O-ring.	 250477 Qty. 4 I.D. 20.29 mm. Th. 2.62 mm. O-ring.	 250134 Qty. 4 I.D. 20.22 mm. Th. 3.53 mm. O-ring.	 250528 Qty. 2 R12 1R134A. Standard flow. Valve core.	 250522 Qty. 2 13 mm. low side. Shipping cap.	 250526 Qty. 2 13 mm. low side. Shipping cap.			
 250539 Qty. 2 Spring lock.	 250537 Qty. 2 Spring lock.	 250536 Qty. 2 Spring lock.	 250529 Qty. 2 R134A JRA. High flow. Valve core.	 250524 Qty. 2 16 mm. high side. Shipping cap.	 250527 Qty. 2 16 mm. high side. Shipping cap.			

Servicing Mercedes I

815011

 250439 Qty. 10 I.D. 4.47 mm. Th. 1.78 mm. O-ring.	 250440 Qty. 10 I.D. 7.65 mm. Th. 1.78 mm. O-ring.	 250453 Qty. 10 I.D. 9.25 mm. Th. 1.78 mm. O-ring.	 250441 Qty. 10 I.D. 10.82 mm. Th. 1.78 mm. O-ring.	 250442 Qty. 10 I.D. 14.00 mm. Th. 1.78 mm. O-ring.	 250443 Qty. 10 I.D. 17.17 mm. Th. 1.78 mm. O-ring.	 250345 Qty. 1 384 ml. Oil Lubricant.
 250134 Qty. 10 I.D. 20.22 mm. Th. 3.53 mm. O-ring.	 250478 Qty. 10 I.D. 21.82 mm. Th. 3.53 mm. O-ring.	 250509 Qty. 10 Repl. LC-203. Teflon seal.	 250508 Qty. 10 Repl. LC-100N. Valve seal.	 250543 Qty. 4 Repl. MC-638. Manifold seal 5/8"US.	 250544 Qty. 4 Repl. MC-639. Manifold seal 5/8"US.	
 250545 Qty. 4 Repl. MC-640. Manifold seal 3/4"US.	 250548 Qty. 2 Repl. MC-760. Manifold seal.	 250550 Qty. 2 Repl. MC-762. Manifold seal.				
 250546 Qty. 4 Repl. MC-641. Sealing washer, short.	 250549 Qty. 2 Repl. MC-661. Manifold seal.	 250547 Qty. 4 Repl. MC-763. Sealing washer, long.				

Servicing Mercedes II

815012

 250002 Qty. 2 Servicing 10PA15, -17, 20. Manifold seal.	 250191 Qty. 2 Servicing 10PA15C. BMW, Mercedes. Manifold seal.		 250480 Qty. 10 I.D. 7.5 mm. Th. 2.0 mm. O-ring.	 250440 Qty. 10 I.D. 7.65 mm. Th. 1.78 mm. O-ring.	 250345 Qty. 1 384 ml. Oil Lubricant.	
	 250086 Qty. 10 Servicing SD. I.D. 8.92 mm. Th. 1.83 mm. O-ring.	 250482 Qty. 10 I.D. 10.5 mm. Th. 2.0 mm. O-ring.	 250441 Qty. 10 I.D. 10.82 mm. Th. 1.78 mm. O-ring.	 250442 Qty. 10 I.D. 14.0 mm. Th. 1.78 mm. O-ring.		
 250483 Qty. 10 I.D. 14.0 mm. Th. 2.0 mm. O-ring.	 250448 Qty. 10 I.D. 17.0 mm. Th. 2.0 mm. O-ring.	 250443 Qty. 10 I.D. 17.17 mm. Th. 1.78 mm. O-ring.	 250459 Qty. 10 I.D. 18.72 mm. Th. 2.62 mm. O-ring.	 250478 Qty. 10 I.D. 21.82 mm. Th. 3.53 mm. O-ring.		 250485 Qty. 10 23.03 x 3.53 x 2.64 mm. O-ring.
 250542 Qty. 10 Servicing 10PA. Manifold seal.	 250523 Qty. 6 13 mm. low side. Shipping cap.	 250525 Qty. 6 16 mm. high side. Shipping cap.	 250181 Qty. 10 Servicing SD709. Shipping cap.	 250528 Qty. 10 R12 1R134A. Standard flow. Valve core.		

815013 Servicing Mitsubishi

<p>250512 Qty. 2 Serv. MSC-90C. Manifold seal.</p>	<p>250513 Qty. 2 Serv. MSC-105C. Manifold seal.</p>	<p>250439 Qty. 10 I.D. 4.47 mm. Th. 1.78 mm. O-ring.</p>	<p>250460 Qty. 10 I.D. 6.07 mm. Th. 1.63 mm. O-ring.</p>	<p>250452 Qty. 10 I.D. 6.07 mm. Th. 1.78 mm. O-ring.</p>	<p>250438 Qty. 10 I.D. 7.00 mm. Th. 1.50 mm. O-ring.</p>	<p>250528 Qty. 2 R12 1R134A. Standard flow. Valve core.</p>	<p>250529 Qty. 2 R134A JRA. High flow. Valve core.</p>
<p>250440 Qty. 10 I.D. 7.65 mm. Th. 1.78 mm. O-ring.</p>	<p>250453 Qty. 10 I.D. 9.25 mm. Th. 1.78 mm. O-ring.</p>	<p>250463 Qty. 4 I.D. 10.77 mm. Th. 2.62 mm. O-ring.</p>	<p>250441 Qty. 10 I.D. 10.82 mm. Th. 1.78 mm. O-ring.</p>	<p>250501 Qty. 10 I.D. 12.42 mm. Th. 1.78 mm. O-ring.</p>	<p>250467 Qty. 4 I.D. 12.93 mm. Th. 1.85 mm. O-ring.</p>	<p>250345 Qty. 1 384 ml. Oil Lubricant.</p>	
<p>250457 Qty. 4 I.D. 13.93 mm. Th. 2.62 mm. O-ring.</p>	<p>250442 Qty. 10 I.D. 14.00 mm. Th. 1.78 mm. O-ring.</p>	<p>250152 Qty. 4 I.D. 15.54 mm. Th. 2.62 mm. O-ring.</p>	<p>250479 Qty. 10 I.D. 15.60 mm. Th. 1.78 mm. O-ring.</p>	<p>250522 Qty. 2 13 mm. low side. Shipping cap.</p>	<p>250526 Qty. 2 13 mm. low side. Shipping cap.</p>		
<p>250443 Qty. 10 I.D. 17.17 mm. Th. 1.78 mm. O-ring.</p>	<p>250459 Qty. 4 I.D. 18.72 mm. Th. 2.62 mm. O-ring.</p>	<p>250134 Qty. 4 I.D. 20.22 mm. Th. 3.53 mm. O-ring.</p>	<p>250536 Qty. 2 MC-594. Spring lock</p>	<p>250524 Qty. 2 16 mm. high side. Shipping cap.</p>	<p>250527 Qty. 2 16 mm. high side. Shipping cap.</p>		

815014 Servicing Nissan / Calsonic

<p>250484 Qty. 5 I.D. 4.70 mm. Th. 1.42 mm. O-ring.</p>	<p>250452 Qty. 5 I.D. 6.07 mm. Th. 1.42 mm. O-ring.</p>	<p>250454 Qty. 5 I.D. 6.80 mm. Th. 1.87 mm. O-ring.</p>	<p>250487 Qty. 5 I.D. 6.88 mm. Th. 1.77 mm. O-ring.</p>	<p>250440 Qty. 5 I.D. 7.65 mm. Th. 1.78 mm. O-ring.</p>	<p>250463 Qty. 5 I.D. 10.77 mm. Th. 2.62 mm. O-ring.</p>	<p>250345 Qty. 1 384 ml. Oil Lubricant.</p>	
<p>250441 Qty. 5 I.D. 10.82 mm. Th. 1.78 mm. O-ring.</p>	<p>250489 Qty. 5 I.D. 10.90 mm. Th. 2.43 mm. O-ring.</p>	<p>250491 Qty. 5 I.D. 11.00 mm. Th. 2.40 mm. O-ring.</p>	<p>250445 Qty. 5 I.D. 13.30 mm. Th. 2.30 mm. O-ring.</p>	<p>250494 Qty. 5 I.D. 13.60 mm. Th. 2.43 mm. O-ring.</p>	<p>250442 Qty. 5 I.D. 14.00 mm. Th. 1.78 mm. O-ring.</p>		
<p>250447 Qty. 5 I.D. 16.50 mm. Th. 2.43 mm. O-ring.</p>	<p>250500 Qty. 5 I.D. 16.60 mm. Th. 2.40 mm. O-ring.</p>	<p>250443 Qty. 5 I.D. 17.17 mm. Th. 1.78 mm. O-ring.</p>	<p>250526 Qty. 2 13 mm. low side. Shipping cap.</p>	<p>250523 Qty. 2 13 mm. low side. Shipping cap.</p>	<p>250527 Qty. 2 16 mm. high side. Shipping cap.</p>		
<p>250528 Qty. 4 R12 1R134A. Standard flow. Valve core.</p>	<p>250529 Qty. 4 R134A JRA. High flow. Valve core.</p>	<p>250527 Qty. 2 16 mm. high side. Shipping cap.</p>	<p>250525 Qty. 2 16 mm. high side. Shipping cap.</p>				

Servicing Opel / Vauxhall I

815015

 250479 Qty. 10 I.D. 15.60 mm. Th. 1.78 mm. O-ring.	 250474 Qty. 10 I.D. 17.12 mm. Th. 2.62 mm. O-ring.	 250459 Qty. 10 I.D. 18.72 mm. Th. 2.62 mm. O-ring.	 250470 Qty. 10 I.D. 19.18 mm. Th. 2.46 mm. O-ring.	 250134 Qty. 10 I.D. 20.22 mm. Th. 3.53 mm. O-ring.	 250478 Qty. 10 I.D. 21.28 mm. Th. 3.53 mm. O-ring.	 250345 Qty. 1 384 ml. Oil Lubricant.
 250505 Qty. 10 I.D. 21.90 mm. Th. 2.62 mm. O-ring.	 250450 Qty. 10 I.D. 23.47 mm. Th. 2.62 mm. O-ring.	 250485 Qty. 10 I.D. 23.03 mm. Th. 3.53 mm. H. 2.64 mm. O-ring.	 250532 Qty. 4 Replacing MC-565. Large bore, high flow. Valve core.	 250528 Qty. 10 R12 1R134A. Standard flow. Valve core.	 250181 Qty. 6 Shipping cap.	
 250522 Qty. 5 13 mm. low side. Shipping cap.	 250546 Qty. 4 Replacing MC-641. Sealing washer, short.	 250547 Qty. 4 Replacing MC-763. Sealing washer, long.	 250544 Qty. 4 Replacing MC-639. Manifold seal 5/8US.			
 250524 Qty. 5 16 mm. high side. Shipping cap.	 250543 Qty. 4 Replacing MC-638. Manifold seal 5/8US.		 250545 Qty. 4 Replacing MC-640. Manifold seal 3/4US.			

Servicing Opel / Vauxhall II

815016

 250439 Qty. 10 I.D. 4.47 mm. Th. 1.78 mm. O-ring.	 250473 Qty. 10 I.D. 6.60 mm. Th. 2.00 mm. O-ring.	 250465 Qty. 10 I.D. 7.38 mm. Th. 1.81 mm. O-ring.	 250440 Qty. 10 I.D. 7.65 mm. Th. 1.78 mm. O-ring.	 250462 Qty. 10 I.D. 9.19 mm. Th. 2.62 mm. O-ring.	 250453 Qty. 10 I.D. 9.25 mm. Th. 1.78 mm. O-ring.	 250345 Qty. 1 384 ml. Oil Lubricant.
 250492 Qty. 10 I.D. 9.25 mm. Th. 2.39 mm. O-ring.	 250493 Qty. 10 I.D. 9.60 mm. Th. 1.88 mm. O-ring.	 250463 Qty. 10 I.D. 10.77 mm. Th. 2.62 mm. O-ring.	 250456 Qty. 10 I.D. 10.80 mm. Th. 2.00 mm. O-ring.	 250441 Qty. 10 I.D. 10.82 mm. Th. 1.78 mm. O-ring.	 250496 Qty. 10 I.D. 12.01 mm. Th. 1.88 mm. O-ring.	
 250488 Qty. 10 I.D. 13.87 mm. Th. 3.53 mm. O-ring.	 250457 Qty. 10 I.D. 13.95 mm. Th. 2.62 mm. O-ring.	 250442 Qty. 10 I.D. 14.00 mm. Th. 1.78 mm. O-ring.				
 250495 Qty. 10 I.D. 14.81 mm. Th. 1.88 mm. O-ring.	 250490 Qty. 10 I.D. 15.47 mm. Th. 3.53 mm. O-ring.		 250443 Qty. 10 I.D. 17.17 mm. Th. 1.78 mm. O-ring.			

815017 Servicing Renault

 250439 Qty. 10 I.D. 4.47 mm. Th. 1.78 mm. O-ring.	 250484 Qty. 10 I.D. 4.70 mm. Th. 1.42 mm. O-ring.	 250460 Qty. 10 I.D. 6.07 mm. Th. 1.63 mm. O-ring.	 250452 Qty. 10 I.D. 6.07 mm. Th. 1.78 mm. O-ring.	 250438 Qty. 10 I.D. 7.00 mm. Th. 1.50 mm. O-ring.	 250440 Qty. 10 I.D. 7.65 mm. Th. 1.78 mm. O-ring.	 250345 Qty. 1 384 ml. Oil Lubricant.
 250453 Qty. 10 I.D. 9.25 mm. Th. 1.78 mm. O-ring.	 250441 Qty. 10 I.D. 10.82 mm. Th. 1.78 mm. O-ring.	 250442 Qty. 10 I.D. 14.0 mm. Th. 1.78 mm. O-ring.	 250152 Qty. 10 I.D. 15.54 mm. Th. 2.62 mm. O-ring.	 250474 Qty. 10 I.D. 17.12 mm. Th. 2.62 mm. O-ring.	 250443 Qty. 10 I.D. 17.17 mm. Th. 1.78 mm. O-ring.	
 250459 Qty. 10 I.D. 18.72 mm. Th. 2.62 mm. O-ring.	 250181 Qty. 10 Serv. SD709. Shipping cap.		 250522 Qty. 5 13 mm. low side. Shipping cap.			
 250528 Qty. 10 R12 1R134A. Standard flow. Valve core.	 250530 Qty. 5 R12 1R134A. Valve core.		 250524 Qty. 5 16 mm. high side. Shipping cap.			

815018 Servicing Suzuki

 250439 Qty. 5 I.D. 4.47 mm. Th. 1.78 mm. O-ring.	 250460 Qty. 5 I.D. 6.70 mm. Th. 1.63 mm. O-ring.	 250438 Qty. 5 I.D. 7.00 mm. Th. 1.50 mm. O-ring.	 250440 Qty. 5 I.D. 7.65 mm. Th. 1.78 mm. O-ring.	 250345 Qty. 1 384 ml. Oil Lubricant.
 250441 Qty. 5 I.D. 10.82 mm. Th. 1.78 mm. O-ring.		 250442 Qty. 5 I.D. 14.0 mm. Th. 1.78 mm. O-ring.	 250476 Qty. 5 I.D. 15.00 mm. Th. 2.50 mm. O-ring.	
 250443 Qty. 5 I.D. 17.17 mm. Th. 1.78 mm. O-ring.		 250522 Qty. 2 13 mm. low side. Shipping cap.	 250526 Qty. 2 13 mm. low side. Shipping cap.	
 250528 Qty. 4 R12 1R134A. Standard flow. Valve core.	 250529 Qty. 4 R134A JRA. High flow. Valve core.	 250524 Qty. 2 16 mm. high side. Shipping cap.	 250527 Qty. 2 16 mm. high side. Shipping cap.	

O.E.M. names and numbers are used for reference purposes only.

Servicing Toyota

815019

<p>250002 Qty. 4 Servicing 10PA15, -17, -20. Manifold Seal.</p>	<p>250439 Qty. 5 I.D. 4.47 mm. Th. 1.78 mm. O-ring.</p>	<p>250473 Qty. 5 I.D. 6.60 mm. Th. 2.00 mm. O-ring.</p>	<p>250438 Qty. 5 I.D. 7.00 mm. Th. 1.50 mm. O-ring.</p>	<p>250440 Qty. 5 I.D. 7.65 mm. Th. 1.78 mm. O-ring.</p>	<p>250345 Qty. 1 384 ml. Oil Lubricant.</p>
	<p>250441 Qty. 5 I.D. 10.82 mm. Th. 1.78 mm. O-ring.</p>	<p>250471 Qty. 4 I.D. 11.0 mm. Th. 2.5 mm. O-ring.</p>	<p>250475 Qty. 4 I.D. 13.46 mm. Th. 2.08 mm. O-ring.</p>	<p>250442 Qty. 5 I.D. 14.0 mm. Th. 1.78 mm. O-ring.</p>	
<p>250461 Qty. 4 I.D. 14.0 mm. Th. 2.5 mm. O-ring.</p>	<p>250476 Qty. 4 I.D. 15.00 mm. Th. 2.50 mm. O-ring.</p>	<p>250152 Qty. 4 I.D. 15.54 mm. Th. 2.62 mm. O-ring.</p>	<p>250528 Qty. 2 R121R134A. Standard flow. Valve core.</p>	<p>250522 Qty. 2 13 mm. low side. Shipping cap.</p>	<p>250526 Qty. 2 13 mm. low side. Shipping cap.</p>
<p>250443 Qty. 5 I.D. 14.0 mm. Th. 1.78 mm. O-ring.</p>	<p>250459 Qty. 4 I.D. 18.72 mm. Th. 2.62 mm. O-ring.</p>	<p>250134 Qty. 4 I.D. 20.22 mm. Th. 3.53 mm. O-ring.</p>	<p>250529 Qty. 2 R134A JRA. High flow. Valve core.</p>	<p>250524 Qty. 2 16 mm. high side. Shipping cap.</p>	<p>250527 Qty. 2 16 mm. high side. Shipping cap.</p>

Servicing Volvo / Saab

815020

<p>250439 Qty. 10 I.D. 4.47 mm. Th. 1.78 mm. O-ring.</p>	<p>250497 Qty. 10 I.D. 7.00 mm. Th. 1.50 mm. O-ring.</p>	<p>250440 Qty. 10 I.D. 7.65 mm. Th. 1.78 mm. O-ring.</p>	<p>250086 Qty. 10 I.D. 8.92 mm. Th. 1.83 mm. O-ring.</p>	<p>250462 Qty. 10 I.D. 9.19 mm. Th. 2.62 mm. O-ring.</p>	<p>250533 Qty. 10 I.D. 9.25 mm. Th. 1.78 mm. O-ring.</p>	<p>250345 Qty. 1 384 ml. Oil Lubricant.</p>
<p>250534 Qty. 10 I.D. 10.82 mm. Th. 1.78 mm. O-ring.</p>	<p>250501 Qty. 10 I.D. 12.42 mm. Th. 1.78 mm. O-ring.</p>	<p>250488 Qty. 10 I.D. 13.87 mm. Th. 3.53 mm. O-ring.</p>	<p>250535 Qty. 10 I.D. 14.00 mm. Th. 1.78 mm. O-ring.</p>	<p>250498 Qty. 10 I.D. 16.60 mm. Th. 2.40 mm. O-ring.</p>	<p>250701 Qty. 10 I.D. 17.17 mm. Th. 1.78 mm. O-ring.</p>	
<p>250134 Qty. 10 I.D. 20.22 mm. Th. 3.53 mm. O-ring.</p>	<p>250499 Qty. 10 I.D. 21.60 mm. Th. 2.40 mm. O-ring.</p>	<p>250523 Qty. 6 13 mm. low side. Shipping cap.</p>	<p>250528 Qty. 10 R121R134A. Standard flow. Valve core.</p>			
<p>250505 Qty. 10 I.D. 21.90 mm. Th. 2.62 mm. O-ring.</p>	<p>250181 Qty. 6 Servicing SD709. Shipping cap.</p>	<p>250525 Qty. 6 16 mm. high side. Shipping cap.</p>	<p>250531 Qty. 10 R124A M8. High flow. Valve core.</p>			

815021 O-Rings I (European Type)

 250439 Qty. 10 I.D. 4.47 mm. Th. 1.78 mm. Green HNBR.	 250452 Qty. 10 I.D. 6.07 mm. Th. 1.78 mm. Green HNBR.	 250473 Qty. 10 I.D. 6.60 mm. Th. 2.00 mm. Green HNBR.	 250455 Qty. 10 I.D. 6.73 mm. Th. 1.63 mm. (Neoprene).	 250454 Qty. 10 I.D. 6.80 mm. Th. 1.87 mm. Green HNBR.	 250487 Qty. 10 I.D. 6.88 mm. Th. 1.77 mm. Green HNBR.	 250438 Qty. 10 I.D. 7.00 mm. Th. 1.50 mm. Green HNBR.	 250480 Qty. 10 I.D. 7.50 mm. Th. 2.00 mm. Green HNBR.
 250440 Qty. 10 I.D. 7.65 mm. Th. 1.78 mm. Green HNBR.	 250444 Qty. 10 I.D. 8.00 mm. Th. 2.00 mm. Green HNBR.	 250086 Qty. 10 Serv. SD. I.D. 8.92 mm. Th. 1.83 mm. O-ring for pressure valve. (Neoprene).		 250507 Qty. 10 I.D. 9.00 mm. Th. 2.00 mm. Green HNBR.		 SIL LUBE MOBILE A/C SILICON O-RING LUBE • Compatible with ALL O-Ring gasket materials • Prevents O-ring plasticity during installation • Extends O-ring life • Perfect as a pre-manufacture to re-manufacturing process	
 250492 Qty. 10 I.D. 9.25 mm. Th. 2.29 mm. (Neoprene).	 250802 Qty. 10 I.D. 10.00 mm. Th. 2.50 mm. Green HNBR.		 250464 Qty. 10 I.D. 10.12 mm. Th. 1.85 mm. Green HNBR.				
 250456 Qty. 10 I.D. 10.80 mm. Th. 2.00 mm. Green HNBR.	 250489 Qty. 10 I.D. 10.90 mm. Th. 2.43 mm. Green HNBR.		 250471 Qty. 10 I.D. 11.00 mm. Th. 2.50 mm. (Neoprene).				
250345 Qty. 1 384 ml. Oil Lubricant.							

815022 O-Rings II (European Type)

 250465 Qty. 10 I.D. 7.38 mm. Th. 1.81 mm. Green HNBR.	 250453 Qty. 10 I.D. 9.25 mm. Th. 1.78 mm. Green HNBR.	 250482 Qty. 10 I.D. 10.50 mm. Th. 2.00 mm. Green HNBR.	 250441 Qty. 10 I.D. 10.82 mm. Th. 1.78 mm. Green HNBR.	 250491 Qty. 10 I.D. 11.00 mm. Th. 2.40 mm. Green HNBR.	 250502 Qty. 10 I.D. 11.91 mm. Th. 2.39 mm. (Neoprene).	 250501 Qty. 10 I.D. 12.42 mm. Th. 1.78 mm. Green HNBR.	 250467 Qty. 10 I.D. 12.93 mm. Th. 1.85 mm. Green HNBR.
 250486 Qty. 10 I.D. 13.00 mm. Th. 2.50 mm. (Neoprene).	 250466 Qty. 10 I.D. 13.10 mm. Th. 1.60 mm. Green HNBR.	 250494 Qty. 10 I.D. 13.60 mm. Th. 2.43 mm. Green HNBR.		 250503 Qty. 10 I.D. 14.00 mm. Th. 1.50 mm. Green HNBR.		 SIL LUBE MOBILE A/C SILICON O-RING LUBE • Compatible with ALL O-Ring gasket materials • Prevents O-ring plasticity during installation • Extends O-ring life • Perfect as a pre-manufacture to re-manufacturing process	
 250442 Qty. 10 I.D. 14.00 mm. Th. 1.78 mm. Green HNBR.		 250483 Qty. 10 I.D. 14.00 mm. Th. 2.50 mm. (Neoprene).		 250461 Qty. 10 I.D. 14.00 mm. Th. 2.50 mm. (Neoprene).			
 250445 Qty. 10 I.D. 14.30 mm. Th. 2.30 mm. Green HNBR.	 250500 Qty. 10 I.D. 14.60 mm. Th. 2.40 mm. Green HNBR.		 250476 Qty. 10 I.D. 15.00 mm. Th. 2.50 mm. Green HNBR.				
250345 Qty. 1 384 ml. Oil Lubricant.							

O.E.M. names and numbers are used for reference purposes only.

O-Rings III (European Type)

815023

 250462 Qty. 10 I.D. 9.19 mm. Th. 2.62 mm. GreenHNBR.	 250463 Qty. 10 I.D. 10.77 mm. Th. 2.62 mm. GreenHNBR.	 250448 Qty. 10 I.D. 14.00 mm. Th. 2.50 mm. GreenHNBR.	 250152 Qty. 10 I.D. 15.54 mm. Th. 2.62 mm. GreenHNBR.	 250479 Qty. 10 I.D. 15.60 mm. Th. 1.78 mm. GreenHNBR.	 250468 Qty. 10 I.D. 15.68 mm. Th. 1.93 mm. GreenHNBR.	 250446 Qty. 10 I.D. 16.00 mm. Th. 1.78 mm. GreenHNBR.	 250447 Qty. 10 I.D. 16.50 mm. Th. 2.43 mm. GreenHNBR.	
 250457 Qty. 10 I.D. 17.00 mm. Th. 2.00 mm. GreenHNBR.	 250474 Qty. 10 I.D. 17.12 mm. Th. 2.62 mm. GreenHNBR.	 250443 Qty. 10 I.D. 17.17 mm. Th. 1.78 mm. GreenHNBR.	 250498 Qty. 10 I.D. 17.60 mm. Th. 2.40 mm. GreenHNBR.	 SIL LUBI MOBILE A/C SILICON O-RING LUBE • Compatible with FKM (Viton) O-ring, gasket materials • Prevents O-ring preloading heating during installation • Extends O-ring life • Perfect as a pre-lubrication in manufacturing process				
 250481 Qty. 10 I.D. 17.80 mm. Th. 2.40 mm. (Neoprene).	 250459 Qty. 10 I.D. 18.72 mm. Th. 2.62 mm. GreenHNBR.	 250472 Qty. 10 I.D. 20.00 mm. Th. 2.40 mm. GreenHNBR.						
 250477 Qty. 10 I.D. 20.29 mm. Th. 2.62 mm. GreenHNBR.	 250504 Qty. 10 I.D. 20.35 mm. Th. 1.78 mm. GreenHNBR.	 250087 Qty. 10 Serv. SD505, -507. I.D. 21.60 mm. Th. 2.40 mm. O-ring for pressure valve.						
						 250345 Qty. 1 384 ml. Oil Lubricant.		

O-Rings IV (European Type)

815024

 250484 Qty. 10 I.D. 4.70 mm. Th. 1.42 mm. GreenHNBR.	 250460 Qty. 10 I.D. 6.07 mm. Th. 1.63 mm. GreenHNBR.	 250469 Qty. 10 I.D. 7.65 mm. Th. 1.63 mm. GreenHNBR.	 250493 Qty. 10 I.D. 9.60 mm. Th. 1.88 mm. GreenHNBR.	 250496 Qty. 10 I.D. 12.01 mm. Th. 1.88 mm. GreenHNBR.	 250506 Qty. 10 I.D. 13.46 mm. Th. 2.08 mm. GreenHNBR.	 250488 Qty. 10 I.D. 13.87 mm. Th. 3.53 mm. GreenHNBR.	 250495 Qty. 10 I.D. 14.81 mm. Th. 1.88 mm. GreenHNBR.	 250490 Qty. 10 I.D. 15.47 mm. Th. 3.53 mm. GreenHNBR.
 250509 Qty. 10 Serv. Tecumseh. I.D. 19.00 mm. Th. 1.50 mm. Seal.	 250470 Qty. 10 I.D. 19.18 mm. Th. 2.46 mm. GreenHNBR.	 250134 Qty. 10 I.D. 20.22 mm. Th. 3.53 mm. GreenHNBR.	 SIL LUBI MOBILE A/C SILICON O-RING LUBE • Compatible with FKM (Viton) O-ring, gasket materials • Prevents O-ring preloading heating during installation • Extends O-ring life • Perfect as a pre-lubrication in manufacturing process					
 250478 Qty. 10 I.D. 21.82 mm. Th. 3.53 mm. GreenHNBR.	 250505 Qty. 10 I.D. 21.90 mm. Th. 2.62 mm. GreenHNBR.	 250485 Qty. 10 23.03 x 3.53 x 2.64 mm. GreenHNBR.						
 250450 Qty. 10 I.D. 23.47 mm. Th. 2.62 mm. GreenHNBR.	 250508 Qty. 10 Serv. Tecumseh. I.D. 23.50 mm. Th. 2.00 mm. Seal (valve).	 250542 Qty. 10 Serv. 10PA. Mercedes I.D. 24.50 mm. Th. 2.20 mm. Manifold seal (Neoprene).						
						 250345 Qty. 1 384 ml. Oil Lubricant.		

815025 **Seal (European Type)**

 250002 Qty. 10 Serv. 10PA15, -15E. Th. 3.30 mm. Manifold seal.		 250513 Qty. 10 Serv. MSC-105C. Th. 1.50 mm. Manifold seal.		 250514 Qty. 10 Serv. 10PA17C. BMW Th. 3.40 mm. Manifold seal.		 250520 Qty. 10 Serv. Renault. O.D. 18.00 mm. Th. 3.00 mm. Manifold seal, molded.		 250521 Qty. 10 Serv. Renault. O.D. 20.70 mm. Th. 2.60 mm. Manifold seal, molded dual.	
 250512 Qty. 10 Serv. MSC-90C. Th. 1.80 mm. Manifold seal.		 250191 Qty. 10 Serv. 10PA15C. BMW, Mercedes. Th. 3.50 mm. Manifold seal.		 250510 Qty. 10 Serv. NL1300AE4, AB4, NL1302AE4. Th. 1.50 mm. Manifold seal.		 250511 Qty. 10 Serv. SA1150X3. Th. 1.50 mm. Manifold seal.		 250515 Qty. 10 Serv. Citroen. Peugeot, Renault. O.D. 20.50 mm. I.D. 18.00 mm. Th. 8.30 mm. Manifold seal.	
 250516 Qty. 10 Serv. Citroen. Peugeot, Renault. O.D. 17.45 mm. I.D. 15.00 mm. Th. 8.60 mm. Manifold seal.		 250517 Qty. 10 Serv. Citroen. Peugeot, Renault. O.D. 14.20 mm. I.D. 11.90 mm. Th. 8.60 mm. Manifold seal.		 250518 Qty. 10 Serv. Citroen. Peugeot, Renault. O.D. 10.90 mm. I.D. 8.60 mm. Th. 8.90 mm. Manifold seal.		 250519 Qty. 10 Serv. Peugeot. O.D. 14.70 mm. Th. 2.60 mm. Manifold seal, molded dual.		 250345 Qty. 1 384 ml. Oil Lubricant.	



815026 **Truck Service Kit - O-rings**

 250439 Qty. 10 I.D. 4.47 mm. Th. 1.78 mm. GreenHNBR.		 252165 Qty. 10 I.D. 6.02 mm. Th. 2.62 mm. GreenHNBR.		 250465 Qty. 10 I.D. 7.38 mm. Th. 1.81 mm. GreenHNBR.		 250440 Qty. 10 I.D. 7.65 mm. Th. 1.78 mm. GreenHNBR.		 250462 Qty. 10 I.D. 9.19 mm. Th. 2.62 mm. GreenHNBR.		 250453 Qty. 10 I.D. 9.25 mm. Th. 1.78 mm. GreenHNBR.		 250464 Qty. 10 I.D. 10.12 mm. Th. 1.85 mm. GreenHNBR.		 250441 Qty. 10 I.D. 10.82 mm. Th. 1.78 mm. GreenHNBR.	
 252164 Qty. 10 I.D. 12.37 mm. Th. 2.62 mm. GreenHNBR.		 250467 Qty. 10 I.D. 12.93 mm. Th. 1.85 mm. GreenHNBR.		 250457 Qty. 10 I.D. 13.95 mm. Th. 2.62 mm. GreenHNBR.		 250442 Qty. 10 I.D. 14.00 mm. Th. 1.78 mm. GreenHNBR.		 250152 Qty. 10 I.D. 15.54 mm. Th. 2.62 mm. GreenHNBR.		 250468 Qty. 10 I.D. 15.68 mm. Th. 1.93 mm. GreenHNBR.					
 250474 Qty. 10 I.D. 17.12 mm. Th. 2.62 mm. GreenHNBR.		 250443 Qty. 10 I.D. 17.17 mm. Th. 2.62 mm. GreenHNBR.		 250481 Qty. 10 I.D. 17.80 mm. Th. 2.40 mm. GreenHNBR.		 250459 Qty. 10 I.D. 18.72 mm. Th. 2.62 mm. GreenHNBR.		 250642 Qty. 10 I.D. 18.89 mm. Th. 3.65 x 2.79 mm. GreenHNBR.		 250470 Qty. 10 I.D. 19.18 mm. Th. 2.46 mm. GreenHNBR.					
 250134 Qty. 10 I.D. 20.22 mm. Th. 3.53 mm. GreenHNBR.		 250477 Qty. 10 I.D. 20.29 mm. Th. 2.62 mm. GreenHNBR.		 250087 Qty. 10 I.D. 21.60 mm. Th. 2.40 mm.		 250478 Qty. 10 I.D. 21.82 mm. Th. 3.53 mm. GreenHNBR.		 250505 Qty. 10 I.D. 21.90 mm. Th. 2.62 mm. GreenHNBR.		 250485 Qty. 10 I.D. 23.03 mm. Th. 3.53 x 2.64 mm. GreenHNBR.					

O.E.M. names and numbers are used for reference purposes only.

Truck Service Kit - Gasket, Seal, Washer, Orifice Tube 815027

 252167 Qty. 5 Serv. Opel, Vauxhall, Volvo. Orifice tube. Black white.	 252168 Qty. 5 Serv. Audi, Jaguar, Vauxhall, Rolls Royce, Vauxhall, Volvo. Orifice tube. White.	 252169 Qty. 5 Serv. Ford. Orifice tube. Blue.	 250002 Qty. 2 Serv. 10PA15, -15E, -17, -20. Th. 3.30 mm. Manifold seal.		 250508 Qty. 6 Serv. Tecumseh. O.D. 23.5 mm. Th. 2.0 mm. Seal (valve).	 250345 Qty. 1 384 ml. Oil lubricant.
			 252166 Qty. 3 Serv. York. Th. 0.9 mm. Gasket for valve.	 250509 Qty. 6 Serv. CC1, Tecumseh. O.D. 19.0 mm. Th. 1.5 mm. Seal.		
 252177 Qty. 6 O.D. 6.0 mm. I.D. 3.7 mm. Th. 9.4 mm. Seal.	 252178 Qty. 6 Hose depressor.	 252179 Qty. 6 L. 19.1 mm. Th. 1.0 mm. Hose depressor.	 252175 Qty. 6 Control valve, screen.	 252176 Qty. 6 O.D. 8.3 mm. I.D. 5.2 mm. Th. 7.3 mm. Seal.		
 252171 Qty. 6 10.7 x 5.5 x 2.5 mm. (Beveled). Washer, copper.	 252172 Qty. 6 13.7 x 7.9 x 2.9 mm. (Beveled). Washer, copper.	 252173 Qty. 6 16.6 x 10.4 x 3.0 mm. (Beveled). Washer, copper.	 252174 Qty. 6 19.47 x 12.6 x 3.0 mm. (Beveled). Washer, copper.			



















Service Kit - Valve Port, Core, Tool 815028

 250181 Qty. 5 Serv. SD709. Shipping cap for service valve.	 250522 Qty. 5 I.D. 13.4 mm. Shipping cap for suction port.	 250523 Qty. 5 I.D. 13.0 mm. Shipping cap for suction port.	 250524 Qty. 5 I.D. 16.9 mm. Shipping cap for discharge port.
 250525 Qty. 5 I.D. 16.0 mm. Shipping cap for discharge port.	 251511 Qty. 5 Serv. DCW-17D. M12-1.5. Shipping cap for service port w/ O-ring.	 252180 Qty. 5 I.D. 9.3 mm. Shipping cap for high side.	 252181 Qty. 5 I.D. 13.5 mm. Shipping cap w/ seal for service valve.
 252182 Qty. 5 M8, I.D. 13.0 mm. Shipping cap for low side.	 252183 Qty. 5 M8, I.D. 16.0 mm. Shipping cap for high side.	 250528 Qty. 5 R12 / R134A. Standard flow. L. 19.4 mm. Valve core.	 250531 Qty. 5 R134A, M8 high flow. L. 21.5 mm. Valve core.
 252186 Qty. 5 MX low flow. L. 20.3 mm. Valve core.	 211028 Qty. 1 Valve core tool.	 252184 Qty. 5 M8 high flow. L. 13.0 mm. Valve core.	 252185 Qty. 5 M10 high flow. L. 16.0 mm. Valve core.
	 211027 Qty. 1 Valve core tool.		













815029 Truck Service Kit - Shaft Key, Sealing Washer

 250085 Qty. 5 Serv. SD507, -508, -510, -708, -709. 12 x 3.3 x 4.95 mm. Shaft key.	 250543 Qty. 5 Serv. Mercedes, Opel. O.D. 30 mm. I.D. 15.8 mm. Th. 3 mm. Manifold seal.	 250544 Qty. 5 Serv. Chrysler, Mercedes, Opel. O.D. 28 mm. I.D. 15.5 mm. Th. 1.3 mm. Manifold seal.	 250545 Qty. 5 Serv. Mercedes, Opel. O.D. 31.5 mm. I.D. 18 mm. Th. 1.3 mm. Manifold seal.
 250546 Qty. 5 Serv. GM. O.D. 16 mm. Th. 7 mm. Sealing washer - short.	 250547 Qty. 5 Serv. GM. O.D. 15.9 mm. Th. 11.5 mm. Sealing washer - long.	 250548 Qty. 5 Serv. GM. O.D. 30 mm. I.D. 15.6 mm. Th. 5.3 mm. Manifold seal - thick type.	 250549 Qty. 5 Serv. GM. O.D. 30 mm. I.D. 15.5 mm. Th. 3.7 mm. Manifold seal.
 250550 Qty. 5 Serv. GM. O.D. 33.5 mm. I.D. 15.5 mm. Th. 3 mm. Manifold seal.	 250643 Qty. 5 Serv. 6C17, 10P13, -15. L. 12 mm. W. 4 mm. Th. 3.5 mm. Shaft key - short.	 251273 Qty. 5 Serv. Axial. L. 20.1 mm. W. 3.42 mm. Th. 4.02 mm. Shaft key.	 251438 Qty. 5 Serv. A6, R4. L. 16.76 mm. W. 4 mm. Th. 4 mm. Shaft key.
 251480 Qty. 5 Serv. DA6, HR6, HR6HE, R4, V5, V7. L. 12.65 mm. W. 3.92 mm. Th. 3.92 mm. Shaft key.	 251564 Qty. 5 Serv. DA6, HD6, HR6, HR6HE, HT6. 23.65 x 15.5 x 2.15 mm. Washer - small sealing.	 252187 Qty. 5 Serv. York full, mini compressor. L. 16.85 mm. Th. 3.98 mm. Shaft key.	 252188 Qty. 5 Serv. RV2. L. 15.45 mm. W. 5.98 mm. Th. 3.98 mm. Shaft key.

815030 Farm and Contractor Machines - O-rings

 250439 Qty. 10 I.D. 4.47 mm. Th. 1.78 mm. Green HNBR.	 250440 Qty. 10 I.D. 7.65 mm. Th. 1.78 mm. Green HNBR.	 250453 Qty. 10 I.D. 9.25 mm. Th. 1.78 mm. Green HNBR.	 250441 Qty. 10 I.D. 10.82 mm. Th. 1.78 mm. Green HNBR.	 250442 Qty. 10 I.D. 14.00 mm. Th. 1.78 mm. Green HNBR.	 250152 Qty. 10 I.D. 15.54 mm. Th. 2.62 mm. Green HNBR.
 250474 Qty. 10 I.D. 17.12 mm. Th. 2.62 mm. Green HNBR.	 250443 Qty. 10 I.D. 17.17 mm. Th. 1.78 mm. Green HNBR.	 250481 Qty. 10 I.D. 17.8 mm. Th. 2.40 mm. Green HNBR.	 250459 Qty. 10 I.D. 18.72 mm. Th. 2.62 mm. Green HNBR.	 250134 Qty. 10 I.D. 20.22 mm. Th. 3.53 mm. Green HNBR.	 250477 Qty. 10 I.D. 20.29 mm. Th. 2.62 mm. Green HNBR.
 250087 Qty. 10 I.D. 21.60 mm. Th. 2.40 mm.	 250478 Qty. 10 I.D. 21.82 mm. Th. 3.53 mm. Green HNBR.	 250505 Qty. 10 I.D. 21.90 mm. Th. 2.62 mm. Green HNBR.	 250508 Qty. 10 Serv. Tecumseh. O.D. 23.5 mm. Th. 2.0 mm. Seal (valve).	 250509 Qty. 10 Serv. CC1, Tecumseh. O.D. 19.0 mm. Th. 1.5 mm. Seal.	 250345 Qty. 1 384 ml. Oil lubricant.

Farm and Contractor Machines - Gasket, Seal, Washer, Tool 8 1 5 0 3 1

 <p>211028 Qty. 1 Valva core tool.</p>	 <p>250002 Qty. 2 Serv. 10PA15, -15E, -17, -20. Th. 3.3 mm. Manifold seal.</p>		 <p>250543 Qty. 5 Serv. Mercedes, Opel. O.D. 30 mm. 15.8 mm. Th. 3 mm. Manifold seal.</p>
 <p>250544 Qty. 5 Serv. Chrysler, Mercedes, Opel. O.D. 28 mm. 15.5 mm. Th. 1.3 mm. Manifold seal.</p>	 <p>250545 Qty. 5 Serv. Mercedes, Opel. O.D. 31.5 mm. 18 mm. Th. 1.3 mm. Manifold seal.</p>	 <p>250546 Qty. 5 Serv. GM. O.D. 16 mm. Th. 7 mm. Sealing Washer - short.</p>	 <p>250547 Qty. 5 Serv. GM. O.D. 15.9 mm. Th. 11.5 mm. Sealing Washer - long.</p>
 <p>250548 Qty. 5 Serv. GM. O.D. 30 mm. 15.6 mm. Th. 5.3 mm. Manifold seal - thick type.</p>	 <p>250549 Qty. 5 Serv. GM. O.D. 30 mm. 15.5 mm. Th. 3.7 mm. Manifold seal.</p>	 <p>250550 Qty. 5 Serv. GM. O.D. 33.5 mm. 15.5 mm. Th. 3 mm. Manifold seal.</p>	 <p>252166 Qty. 5 Serv. York. Th. 0.9 mm. Gasket for valve.</p>
 <p>252171 Qty. 5 10.7 x 5.5 x 2.5 mm. (Beveled). Washer, copper.</p>	 <p>252172 Qty. 5 13.7 x 7 x 2.9 mm. (Beveled). Washer, copper.</p>	 <p>252173 Qty. 5 16.6 x 10.4 x 3 mm. (Beveled). Washer, copper.</p>	 <p>252174 Qty. 5 19.4 x 12.6 x 3 mm. (Beveled). Washer, copper.</p>

Farm and Contractor Machines - Shaft Key, Shim, Fastener 8 1 5 0 3 2

 <p>190477 Qty. 5 Fully threaded. Steel, el-plated. DIN 933, ISO 4017. M4 x 25 mm. Spanner size: 10 mm.</p>	 <p>190478 Qty. 5 Fully threaded. Steel, el-plated. DIN 933, ISO 4017. M6 x 20 mm. Spanner size: 10 mm.</p>	 <p>190580 Qty. 5 Split spring washer, curved. Spring steel. DIN 128A. I.D. M8.</p>	 <p>250007 Qty. 5 O.D. 11 mm. I.D. 6.4 mm. Th. 0.97 mm. US°0.038.</p>	 <p>250008 Qty. 5 O.D. 11 mm. I.D. 6.4 mm. Th. 1.60 mm. US°0.063.</p>	 <p>250043 Qty. 5 O.D. 12.7 mm. I.D. 8.3 mm. Th. 0.26 mm.</p>
 <p>250044 Qty. 5 O.D. 12.7 mm. I.D. 8.3 mm. Th. 0.39 mm.</p>	 <p>250057 Qty. 5 Serv. 10P15, 10PA17. O.D. 7 mm. L. 12 mm. Wire Clip.</p>	 <p>250085 Qty. 5 Serv. SD507, -508, -510, -708, -709. 12 x 3.3 x 4.95 mm. Shaft key.</p>	 <p>250096 Qty. 5 Serv. SD7, SD508. O.D. 22 mm. I.D. 13 mm. Th. 0.5 mm. Shim.</p>	 <p>250097 Qty. 5 Serv. SD7, SD508. O.D. 21.9 mm. I.D. 13 mm. Th. 1.3 mm. Shim.</p>	 <p>250043 Qty. 5 O.D. 12.7 mm. I.D. 8.3 mm. Th. 0.26 mm.</p>
 <p>250643 Qty. 5 Serv. 6C17, 10P13, -15. L. 12 mm. W. 4 mm. Th. 3.5 mm. Shaft key - short.</p>	 <p>250777 Qty. 5 Serv. DKS-16H. M8-1.25 self locking. Nut.</p>	 <p>251142 Qty. 5 Serv. SD7H15. 11.15 x 8.1 x 0.26 mm. Shim for clutch.</p>	 <p>251273 Qty. 5 Serv. Axial. L. 20.1 mm. W. 3.42 mm. Th. 4.02 mm. Shaft key.</p>	 <p>251438 Qty. 5 Serv. A6, R4. L. 16.76 mm. W. 4 mm. Th. 4 mm. Shaft key.</p>	 <p>251438 Qty. 5 Serv. A6, R4. L. 16.76 mm. W. 4 mm. Th. 4 mm. Shaft key.</p>
 <p>251444 Qty. 5 Serv. A6, R4. O.D. 19 mm. I.D. 10.4 mm. Th. 3.13 mm. Washer for clutch hub.</p>	 <p>251480 Qty. 5 Serv. DA6, HR6, HR6HE, R4, V5, V7. L. 12.65 mm. W. 3.92 mm. Th. 3.92 mm. Shaft key.</p>	 <p>252175 Qty. 5 Control valve, screen.</p>	 <p>252187 Qty. 5 Serv. York full, mini. compressor. L. 16.85 mm. Th. 3.98 mm. Shaft key.</p>	 <p>252191 Qty. 5 Serv. A6, R4. 3/8" UNF. Nut.</p>	 <p>252191 Qty. 5 Serv. A6, R4. 3/8" UNF. Nut.</p>

815033 Farm and Contractor Machines - Shipping Cap, Valve Core

 <p>250181 Qty. 5 Serv. SD709. Shipping cap for service valve.</p>	 <p>250522 Qty. 5 I.D. 13.4 mm. Shipping cap for suction port.</p>	 <p>250523 Qty. 5 I.D. 13 mm. Shipping cap for suction port.</p>	 <p>250524 Qty. 5 I.D. 16.9 mm. Shipping cap for discharge port.</p>
 <p>250525 Qty. 5 I.D. 16 mm. Shipping cap for discharge port.</p>	 <p>250528 Qty. 5 R12 / R134A standard flow. L. 19.4 mm. Valve core.</p>	 <p>252180 Qty. 5 I.D. 9.3 mm. Shipping cap for high side.</p>	 <p>252181 Qty. 5 I.D. 13.5 mm. Shipping cap w/ seal for service valve.</p>
 <p>252182 Qty. 5 M8, I.D. 13 mm. Shipping cap low side.</p>	 <p>252183 Qty. 5 M10, I.D. 16 mm. Shipping cap high side.</p>	 <p>252184 Qty. 5 M8 high flow. L. 13 mm. Valve core.</p>	 <p>252185 Qty. 5 M10 high flow. L. 16 mm. Valve core.</p>
 <p>252186 Qty. 5 MX low flow. L. 20.3 mm. Valve core.</p>	 <p>252192 Qty. 5 Serv. Bridgeport type. System guard.</p>	 <p>252193 Qty. 5 Serv. Aeroquip type. System guard.</p>	 <p>252194 Qty. 5 Serv. Eaton M8 / M10 type. System guard.</p>

815034 Farm and Contractor Machines - Orifice Tubes

 <p>252167 Qty. 5 Serv. Opel, Vauxhall, Volvo. Orifice tube. Black/white.</p>	 <p>252168 Qty. 5 Serv. Audi, Jaguar, Opel, Rolls Royce. Orifice tube. White.</p>	 <p>252169 Qty. 5 Serv. Ford. Orifice tube. Blue.</p>	 <p>252196 Qty. 5 Serv. Ford. Orifice tube. Green.</p>	 <p>252197 Qty. 5 Serv. Ford. Orifice tube. Red.</p>	 <p>252198 Qty. 5 Serv. Ford. Orifice tube. Orange.</p>	 <p>252195 Qty. 5 Serv. GM. Orifice tube. White porous plastic.</p>	
 <p>252199 Qty. 5 Serv. Ford. Orifice tube. Brown.</p>	 <p>252200 Qty. 5 Serv. Chrysler. Orifice tube. Purple.</p>	 <p>252201 Qty. 5 Serv. GM, Volvo. Orifice tube. Yellow/white.</p>	 <p>252202 Qty. 5 Serv. GM. Orifice tube. Yellow/white.</p>	 <p>252203 Qty. 5 Serv. GM. Orifice tube. Orange/white.</p>	 <p>252204 Qty. 5 Serv. Audi, VW. Orifice tube. Grey/white.</p>	 <p>252205 Qty. 5 Serv. GM. Orifice tube. Yellow/White.</p>	 <p>252206 Qty. 5 Serv. Ford. Orifice tube. Black/White.</p>

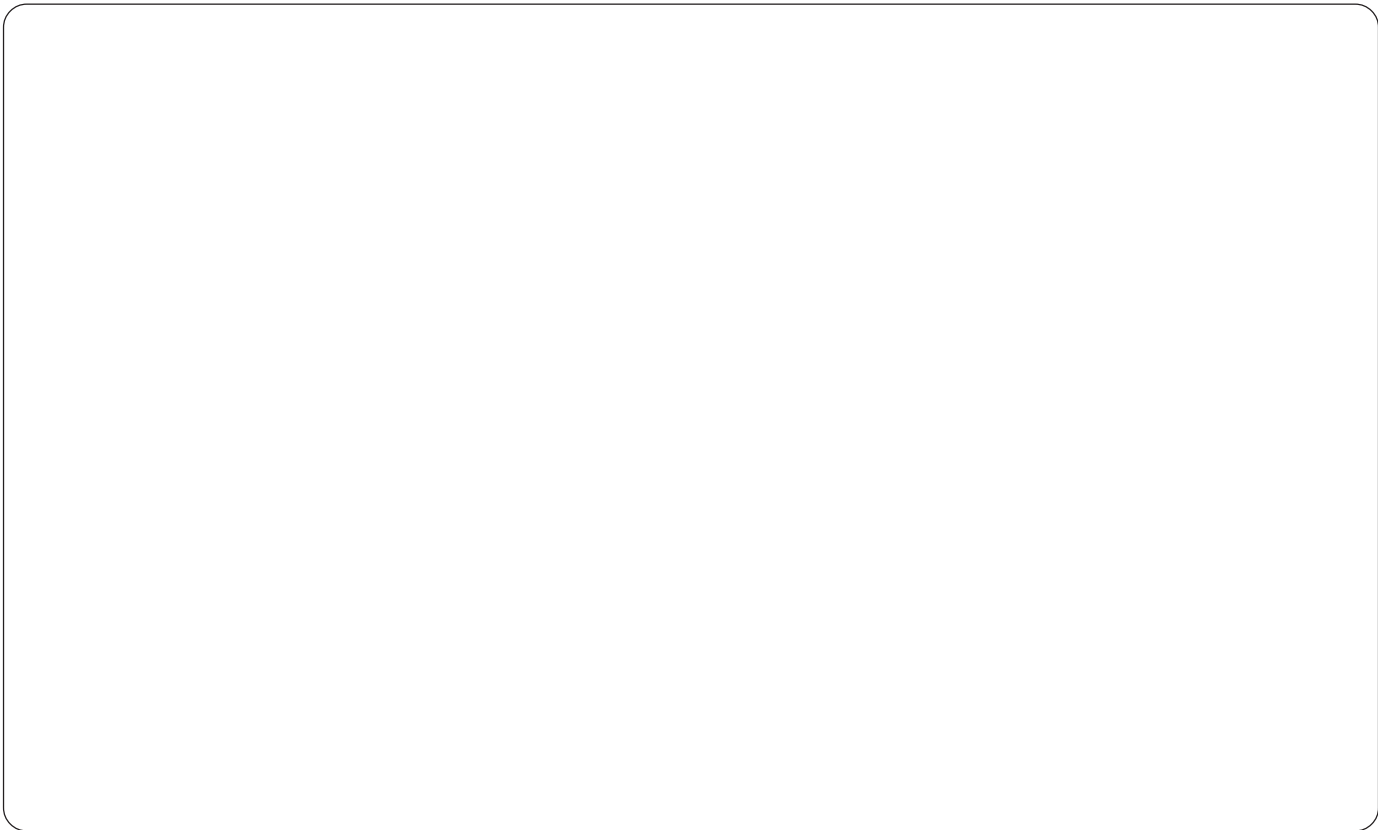
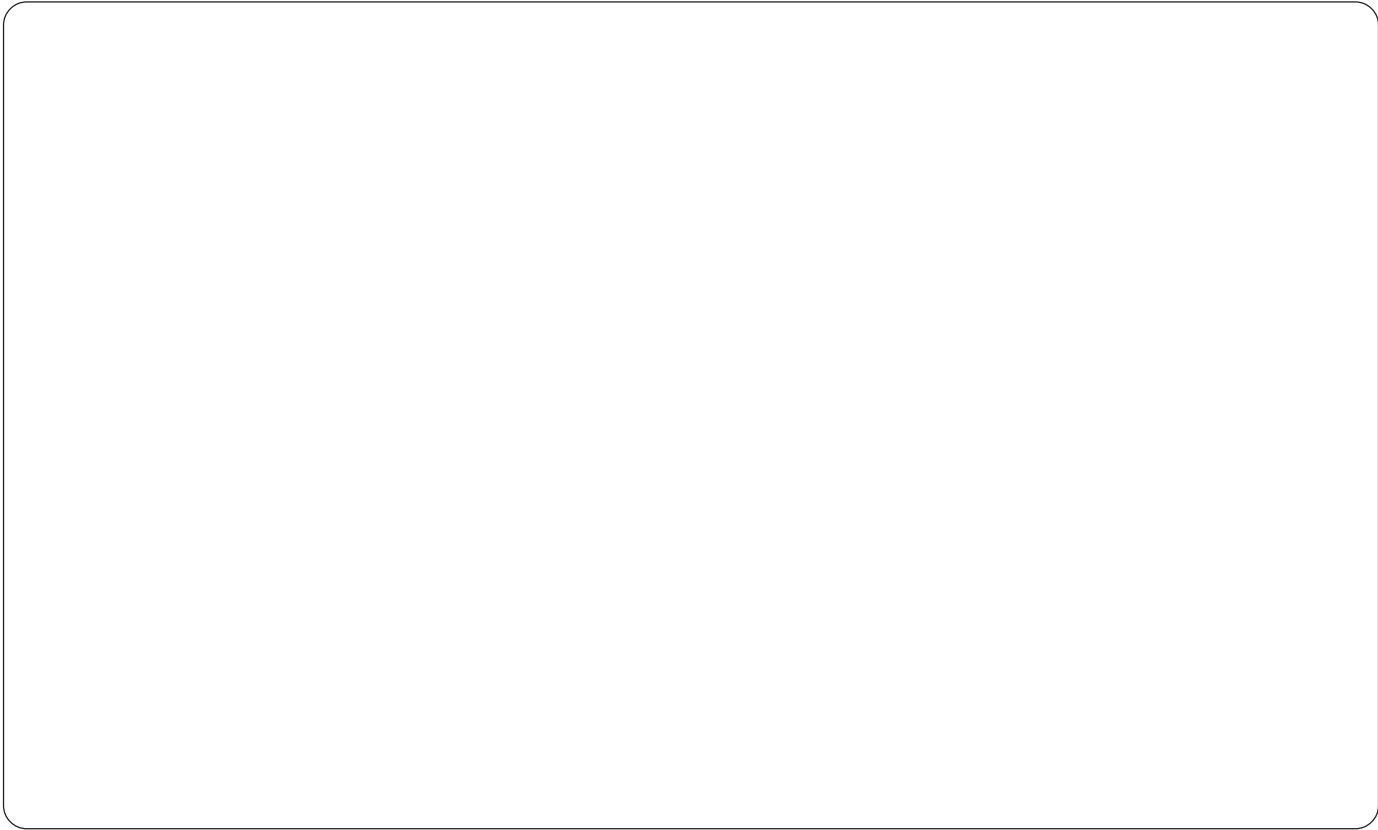



INDEX

PART 12

3rd Edition



ISO/TS 16949:2002 certified supplier

Index for Assortments

Cargo	Assortments	Page
070009	807002	107
070067	807002	107
070070	807002	107
070077	807002	107
080001	802005	15
080003	806020	100
080009	802005	15
<i>or</i>	804020	82
<i>or</i>	806016	96
<i>or</i>	806029	89
080018	806002	97
<i>or</i>	806028	97
080019	806002	97
<i>or</i>	806028	97
080020	806002	97
<i>or</i>	806028	97
080021	806002	97
<i>or</i>	806028	97
080022	806002	97
<i>or</i>	806028	97
080024	806002	97
<i>or</i>	806028	97
080025	806002	97
<i>or</i>	806028	97
080026	806002	97
080027	806002	97
080028	806002	97
080029	806002	97
080030	806002	97
080039	806009	92
080041	806001	101
080042	806001	101
080043	806001	101
080044	806001	101
080045	806001	101
080046	806001	101
080047	806001	101
080048	806001	101
080049	806001	101
080050	806001	101
080051	806001	101
080052	806001	101
080053	806001	101
080054	806001	101
080055	806001	101
080056	806001	101
080057	806001	101
080058	806001	101
080098	806029	89
080099	806014	91
<i>or</i>	806029	89
080123	806029	89
080136	806003	89
080139	806003	89
080140	806003	89
080141	806003	89
<i>or</i>	806029	89
080142	806003	89
080143	806003	89
080144	806003	89
080145	806003	89
080146	806003	89
080154	806003	89
080161	806029	89
080162	806029	89
080163	806029	89
080164	806029	89
080165	806029	89
080166	806003	89

Cargo	Assortments	Page
080169	806003	89
080170	806003	89
080177	806024	90
080178	806024	90
080186	806008	90
080187	806008	90
080188	806008	90
080189	806008	90
080190	806008	90
080191	806008	90
080192	806008	90
080193	806008	90
080194	806008	90
080204	806008	90
080205	806008	90
080207	806024	90
080209	806024	90
080210	806024	90
080212	806024	90
080215	806014	91
080218	806014	91
080220	806014	91
080221	806014	91
080222	806014	91
080223	806014	91
080231	806009	92
080232	806029	89
080236	806010	92
080237	806015	99
<i>or</i>	806020	100
080238	806015	99
<i>or</i>	806020	100
080239	806015	99
<i>or</i>	806020	100
080240	806015	99
<i>or</i>	806020	100
080241	806015	99
<i>or</i>	806020	100
080242	806015	99
<i>or</i>	806020	100
080243	806015	99
<i>or</i>	806020	100
080245	806015	99
080246	806015	99
<i>or</i>	806020	100
080247	806015	99
<i>or</i>	806020	100
080251	806016	96
<i>or</i>	806020	100
080252	802009	13
<i>or</i>	806016	96
<i>or</i>	806020	100
080253	802007	11
<i>or</i>	806016	96
<i>or</i>	806020	100
080254	806016	96
<i>or</i>	806020	100
080255	802005	15
<i>or</i>	802009	13
<i>or</i>	806016	96
<i>or</i>	806020	100
080256	802007	11
<i>or</i>	806016	96
<i>or</i>	806020	100
080257	806016	96
<i>or</i>	806020	100
080258	806016	96
<i>or</i>	806020	100
080259	806015	99

Cargo	Assortments	Page
080260	806015	99
080261	806015	99
080262	806015	99
080263	806015	99
080264	806015	99
080265	806015	99
080268	806018	101
080269	806018	101
080270	806018	101
080271	806018	101
080272	806018	101
080273	806018	101
080274	806021	100
080275	806021	100
080276	806021	100
080277	806018	101
080278	806018	101
080279	806018	101
080280	806018	101
080281	806018	101
080282	806018	101
080287	806018	101
080288	806018	101
080289	806018	101
080290	806016	96
080296	806011	93
080297	806021	100
080299	806007	96
080300	806007	96
080301	806007	96
080302	806007	96
080303	806007	96
080304	806007	96
080305	806007	96
080306	806007	96
080307	806007	96
080308	806007	96
080309	806007	96
080310	806007	96
080311	806007	96
080312	806007	96
080313	806007	96
080314	806007	96
080315	806007	96
080316	806007	96
080317	806007	96
080318	806007	96
080319	806007	96
080320	806007	96
080321	806007	96
080322	806007	96
080323	806007	96
080324	806007	96
080325	806006	95
080326	806006	95
080327	806006	95
080328	806006	95
080329	806006	95
080331	806012	91
080332	806012	91
080333	806012	91
080334	806012	91
080335	806012	91
080336	806012	91
080337	806012	91
080338	806012	91
080339	806012	91
080340	806012	91
080341	806012	91

Index for Assortments

Cargo	Assortments	Page
080342	806012	91
080343	806012	91
080344	806012	91
080345	806012	91
080346	806012	91
080347	806012	91
080348	806012	91
080351	806019	99
080353	806012	91
080385	806009	92
080386	806009	92
080388	806009	92
080389	806019	99
080390	806009	92
080392	806009	92
080393	806009	92
080394	806009	92
080395	806009	92
080397	806009	92
080398	806009	92
080400	806009	92
<i>or</i>	806010	92
080401	806010	92
080402	806009	92
<i>or</i>	806010	92
080403	806010	92
080404	806010	92
080405	806009	92
080406	806010	92
080407	806009	92
080408	806009	92
080409	806009	92
080410	806010	92
080411	806010	92
080412	806010	92
080413	806009	92
<i>or</i>	806010	92
080414	806010	92
080415	806010	92
080416	806010	92
080417	806010	92
080418	806010	92
080419	806010	92
080420	806014	91
<i>or</i>	806029	89
080421	806009	92
080423	806010	92
080424	806011	93
080425	806011	93
080426	806011	93
080427	806011	93
080428	806011	93
080429	806011	93
080430	806011	93
080431	806011	93
080432	806011	93
080433	806011	93
080434	806011	93
080435	806011	93
080436	806011	93
080437	806011	93
080438	806011	93
080439	806011	93
080440	806011	93
080441	806011	93
080442	806011	93
080443	806011	93
080444	806011	93
080446	806011	93

Cargo	Assortments	Page
080447	806011	93
080448	806011	93
080449	806011	93
080450	806011	93
080452	806011	93
080453	806011	93
080454	806011	93
080456	806011	93
080457	806019	99
080458	806019	99
080459	806019	99
080460	806019	99
080468	806006	95
080469	806006	95
080470	806006	95
080471	806006	95
080472	806006	95
080473	806006	95
080474	806006	95
080475	806006	95
080476	806006	95
080477	806006	95
080478	806006	95
080479	806006	95
080480	806006	95
080481	806006	95
080482	806006	95
080483	806006	95
080484	806006	95
080485	806006	95
080486	806005	94
080487	806005	94
080488	806005	94
080489	806005	94
080490	806005	94
080491	806005	94
080492	806005	94
080493	806005	94
080494	806005	94
080495	806005	94
080496	806005	94
080497	806005	94
080498	806005	94
080499	806005	94
080500	806005	94
080501	806005	94
080502	806005	94
080503	806005	94
080504	806005	94
080505	806005	94
080506	806005	94
080507	806004	93
080508	806004	93
080509	806004	93
080510	806004	93
080511	806004	93
080512	806004	93
080513	806004	93
080514	806004	93
080515	806004	93
080516	806004	93
080517	806004	93
080518	806004	93
080519	806004	93
080520	806004	93
080521	806004	93
080522	806004	93
080523	806004	93
080524	806004	93

Cargo	Assortments	Page
080525	806004	93
080526	806004	93
080581	806019	99
080582	806019	99
080583	806019	99
080584	806019	99
080585	806019	99
080586	806019	99
080595	806024	90
080653	806017	98
080654	806017	98
080655	806017	98
080656	806017	98
080657	806017	98
080658	806017	98
080659	806017	98
<i>or</i>	806022	98
080660	806017	98
<i>or</i>	806022	98
080661	806017	98
<i>or</i>	806022	98
080662	806017	98
<i>or</i>	806022	98
080663	806017	98
<i>or</i>	806022	98
080664	806017	98
<i>or</i>	806022	98
080665	806017	98
<i>or</i>	806022	98
080666	806017	98
<i>or</i>	806022	98
080667	806021	100
080668	806021	100
080669	806021	100
080677	806010	92
080688	806011	93
080723	806019	99
080732	806009	92
080736	806009	92
080738	806008	90
080748	806009	92
080753	806008	90
080755	806029	89
080778	806019	99
080779	806019	99
080828	806029	89
080829	806021	100
080830	806021	100
080831	806021	100
080843	806022	98
080854	807002	107
080855	807002	107
080857	807002	107
080858	807002	107
080865	806028	97
080866	806028	97
080867	806028	97
080868	806028	97
080869	806028	97
080870	806028	97
080871	806028	97
080872	806028	97
080876	806025	94
080877	806025	94
080878	806025	94
080879	806025	94
080880	806025	94
080881	806025	94
080882	806025	94

Index for Assortments

Cargo	Assortments	Page
080883	806025	94
080884	806025	94
080885	806025	94
080886	806025	94
080887	806025	94
080888	806025	94
080889	806025	94
080890	806025	94
080891	806025	94
080892	806025	94
080893	806025	94
080894	806025	94
080895	806025	94
080896	806025	94
080897	806025	94
080898	806025	94
080899	806025	94
080900	806025	94
080901	806026	95
080902	806026	95
080903	806026	95
080904	806026	95
080905	806026	95
080906	806026	95
080907	806026	95
080908	806026	95
080909	806026	95
080910	806026	95
080911	806026	95
080912	806026	95
080913	806026	95
080914	806026	95
080915	806026	95
080916	806026	95
080917	806026	95
080918	806026	95
080919	806026	95
080920	806026	95
080921	806026	95
080922	806026	95
080923	806026	95
080924	806026	95
080925	806026	95
080932	806008	90
080954	807002	107
080955	807002	107
080958	807002	107
080959	807002	107
080960	807002	107
080972	806029	89
081112	806029	89
100177	806023	102
100245	806023	102
100246	806027	102
100254	806023	102
100257	806023	102
100258	806023	102
100261	806030	103
100271	806023	102
100276	806023	102
100277	806023	102
100287	806023	102
or.....	806027	102
100291	806023	102
or.....	806027	102
100303	806023	102
or.....	806027	102
100310	806027	102
100324	806023	102

Cargo	Assortments	Page
or.....	806027	102
100325	806023	102
or.....	806027	102
100331	806023	102
or.....	806027	102
100335	806030	103
100436	806027	102
100510	806027	102
100511	806023	102
or.....	806027	102
100512	806023	102
or.....	806027	102
100513	806027	102
100515	806030	103
100519	806027	102
100520	806027	102
100527	806030	103
100531	806030	103
100532	806030	103
100537	806030	103
100538	806030	103
100545	806030	103
100555	806030	103
100557	806030	103
100563	806030	103
100580	806027	102
100592	806030	103
100593	806030	103
130549	802020	10
130558	802020	10
130561	802020	10
130668	802001	9
or.....	802020	10
130669	802011	17
130670	802011	17
130671	802011	17
130672	802011	17
130674	802001	9
130682	802022	16
130703	802015	12
130704	802015	12
130713	802022	16
130714	802022	16
130718	802022	16
130744	803026	36
130813	802015	12
or.....	802016	12
or.....	802028	23
130819	802028	23
130834	802024	17
130842	802014	16
130843	802001	9
130869	803026	36
130871	803026	36
130879	803026	36
130903	802013	14
or.....	802014	16
or.....	802034	22
130910	802016	12
or.....	802028	23
130911	802011	17
130912	802011	17
130933	802013	14
130936	802015	12
or.....	802028	23
130937	802011	17
130961	802022	16
130976	802013	14
131037	802022	16

Cargo	Assortments	Page
131055	802014	16
131218	802013	14
131219	802013	14
131287	802024	17
or.....	802030	11
131292	802011	17
or.....	802016	12
131293	802011	17
or.....	802016	12
131294	802011	17
or.....	802019	8
131298	803026	36
131342	802016	12
or.....	802032	18
131406	803015	31
131410	803015	31
131418	802020	10
131442	803015	31
131444	803011	30
131445	803011	30
131447	803011	30
131448	803011	30
or.....	803039	46
131449	803011	30
or.....	803039	46
131450	803011	30
or.....	803039	46
131453	803011	30
131476	802020	10
131499	803011	30
or.....	803041	45
131503	803008	27
131504	802020	10
131506	802011	17
131507	802011	17
131508	802011	17
131509	802011	17
131510	802011	17
131511	802011	17
131512	802011	17
131513	802011	17
131514	802011	17
131528	802024	17
131554	802015	12
131583	802014	16
131591	803035	42
131592	803035	42
131594	803035	42
131595	803035	42
131605	802013	14
131606	802014	16
131608	802022	16
131618	803034	42
131692	802015	12
131693	802015	12
131704	802022	16
131810	803034	42
131814	802014	16
or.....	802032	18
131815	802014	16
131816	802032	18
131817	802016	12
or.....	802032	18
131818	802013	14
131819	802003	15
131820	802017	9
131821	802017	9
131822	802022	16
or.....	802028	23

Index for Assortments

Cargo	Assortments	Page
131823	802017	9
131824	802017	9
131825	802017	9
131826	802014	16
or	802034	22
131827	802014	16
or	802022	16
or	802034	22
131828	802014	16
or	802019	8
or	802034	22
131830	803004	39
131831	803004	39
131832	803004	39
131833	803004	39
131834	803030	40
131835	803030	40
131836	803030	40
131837	803030	40
131838	803030	40
131841	803011	30
131915	802021	10
131916	802021	10
131924	802021	10
131992	803008	27
132036	803036	43
132037	803036	43
132047	802021	10
132065	802003	15
132066	802003	15
132067	802003	15
132068	803031	40
132080	802008	13
or	802022	16
or	802028	23
132081	802017	9
132084	802003	15
132097	802013	14
132104	803022	35
132113	803015	31
132114	803015	31
132115	803015	31
132116	803015	31
132123	803008	27
132124	803036	43
132131	803015	31
132139	803035	42
132145	803036	43
132146	803036	43
132147	803036	43
132209	803026	36
or	803041	45
132223	803041	45
132224	803041	45
132237	802013	14
132246	803035	42
132248	803035	42
132251	803035	42
132275	803035	42
132276	803035	42
132277	803035	42
132281	803035	42
132292	802024	17
132295	802014	16
or	802020	10
132296	803039	46
132297	802007	11
or	802029	21
132317	802013	14

Cargo	Assortments	Page
132319	802016	12
or	802029	21
132320	802022	16
132322	803035	42
132323	802015	12
132324	802013	14
or	802017	9
or	802028	23
132346	802001	9
or	802020	10
or	802021	10
or	802028	23
132381	803034	42
132382	803015	31
or	803039	46
132397	802017	9
132398	802017	9
132434	802024	17
132549	802005	15
or	802029	21
132550	803030	40
132551	803030	40
or	803041	45
132552	803030	40
or	803041	45
132556	802004	14
132558	802004	14
132563	803004	39
132565	803004	39
132567	803004	39
132568	803004	39
132570	803004	39
132571	803034	42
or	803041	45
132572	802015	12
132576	803010	28
or	803041	45
132581	802001	9
or	802020	10
or	802021	10
132582	802001	9
or	802020	10
or	802021	10
132604	803008	27
132611	802001	9
132638	803028	38
132639	803028	38
132642	802016	12
or	802032	18
132659	802007	11
or	802009	13
or	803007	46
132660	802007	11
or	802009	13
or	802030	11
or	803007	46
132661	802007	11
or	802029	21
or	802030	11
132662	802009	13
or	802029	21
132663	802009	13
or	802029	21
132664	802009	13
or	802029	21
132682	803015	31
or	803039	46
132705	803030	40
132709	803030	40

Cargo	Assortments	Page
132724	803035	42
132730	803015	31
132734	802029	21
132767	802017	9
132768	802017	9
132769	802019	8
or	802034	22
132771	803026	36
132783	802004	14
132784	802004	14
132785	802003	15
132804	802016	12
or	802019	8
132806	802017	9
132807	802017	9
132825	803039	46
132847	803022	35
132848	802014	16
132862	802003	15
132870	803030	40
132877	803015	31
132878	803031	40
132879	803031	40
132885	803030	40
132886	803030	40
132887	803030	40
or	803041	45
132888	803030	40
132889	803030	40
132891	803007	46
132892	803007	46
132893	803007	46
132894	803030	40
132895	803030	40
132896	803030	40
132897	803030	40
132900	803007	46
132928	803026	36
133020	803028	38
or	803039	46
133021	803028	38
133023	803015	31
133024	803015	31
133025	803015	31
133026	803015	31
133027	803015	31
133036	803028	38
133038	802021	10
133040	802005	15
or	803007	46
133055	802013	14
133065	802029	21
133078	803034	42
133092	802008	13
133093	802008	13
133146	803035	42
133193	802011	17
133194	802011	17
133197	803041	45
133198	802001	9
133199	802022	16
133235	802024	17
133236	802024	17
133238	802024	17
133239	802024	17
133240	802024	17
133241	802024	17
133242	802024	17
133243	802024	17

Index for Assortments

Cargo	Assortments	Page
133244	802024	17
133245	802024	17
133246	802024	17
133247	802024	17
133248	802024	17
133249	802024	17
133250	802024	17
133251	802008	13
133252	802008	13
133258	802024	17
133259	802024	17
133270	803036	43
133275	803036	43
133277	802007	11
133279	802007	11
133280	802009	13
133281	802005	15
133282	802005	15
133283	802005	15
133308	803011	30
133351	802014	16
or.....	802022	16
or.....	802032	18
133365	802014	16
133366	802014	16
133370	803006	47
133371	803006	47
133372	803006	47
133373	802019	8
133374	802019	8
133390	803006	47
133401	802015	12
or.....	802019	8
or.....	802032	18
133402	802019	8
or.....	802032	18
133408	802004	14
133409	802008	13
or.....	802032	18
133410	802032	18
133461	803015	31
133463	803028	38
133466	803008	27
133467	803008	27
133468	803009	27
133469	803009	27
133470	803009	27
133471	803009	27
133475	803009	27
133476	803009	27
133477	803009	27
133478	803009	27
133495	802011	17
133496	802011	17
133497	802001	9
133503	803035	42
133505	803006	47
133506	803006	47
133513	802005	15
or.....	802029	21
133514	802005	15
133523	802005	15
or.....	802029	21
133524	802005	15
or.....	802029	21
133525	802003	15
133527	802005	15
133553	803010	28
133555	803010	28

Cargo	Assortments	Page
133556	803041	45
133557	803010	28
or.....	803041	45
133560	802008	13
133568	803035	42
133569	803035	42
133570	803035	42
133571	803035	42
133572	803035	42
133573	803035	42
133575	803035	42
133576	803035	42
133577	803035	42
133578	803035	42
133579	803035	42
133585	802009	13
133597	802005	15
or.....	803007	46
133598	802009	13
or.....	803007	46
133602	803004	39
133604	803011	30
133607	803022	35
133608	803022	35
133609	803022	35
133610	802003	15
133611	803022	35
133612	802008	13
or.....	802028	23
133634	803004	39
133635	803004	39
133637	803026	36
133641	802017	9
133648	802014	16
or.....	802034	22
133650	802022	16
133667	803034	42
133673	802003	15
133676	802003	15
133677	802004	14
133678	802003	15
133679	802003	15
133680	802003	15
133701	802008	13
133704	802008	13
or.....	802011	17
133705	802008	13
or.....	802011	17
133708	803031	40
133710	803030	40
133716	803030	40
133717	803007	46
133731	803022	35
or.....	803041	45
133739	802014	16
133740	802014	16
133784	802015	12
or.....	802028	23
133785	802017	9
or.....	802028	23
133802	802016	12
133810	803030	40
or.....	803041	45
133813	802005	15
133867	802020	10
133891	803036	43
133893	803026	36
133914	803026	36
133915	802003	15

Cargo	Assortments	Page
133924	802021	10
or.....	802032	18
133928	802021	10
133929	802021	10
133935	802021	10
133945	802020	10
or.....	802021	10
133946	802020	10
or.....	802021	10
133947	802021	10
133948	802020	10
or.....	802021	10
133949	802020	10
133962	802009	13
133965	803007	46
133974	803015	31
133980	802008	13
134032	803009	27
134035	803009	27
134038	802016	12
134039	802016	12
134040	803026	36
134064	803006	47
134066	803009	27
134067	803009	27
134068	803009	27
134077	802021	10
134095	803026	36
134096	803026	36
134101	802016	12
134102	802016	12
134106	803034	42
134107	803034	42
134140	802001	9
134141	803035	42
134142	803034	42
134144	802014	16
134146	803036	43
134147	803036	43
134148	803036	43
134149	803036	43
134150	803036	43
134152	803036	43
134153	803036	43
134154	803036	43
134156	803011	30
134160	803008	27
134273	802003	15
or.....	802004	14
or.....	802008	13
or.....	802023	23
134276	802008	13
134277	802008	13
134278	802008	13
134289	803034	42
134290	802007	11
or.....	802009	13
134293	802005	15
134294	802005	15
or.....	803011	30
134328	803040	45
134329	803040	45
134345	802016	12
134374	802004	14
134395	802005	15
134396	802005	15
134397	802007	11
134409	802004	14
134428	802034	22

Index for Assortments

Cargo	Assortments	Page
134429	803015	31
134442	803041	45
134446	803026	36
134451	802016	12
134459	803026	36
134460	803026	36
134477	803022	35
134481	803034	42
or	803039	46
134482	802009	13
or	803007	46
134484	803007	46
134485	803007	46
134486	803007	46
134487	803007	46
134488	803007	46
134489	803007	46
134490	802007	11
or	803007	46
134491	803007	46
134497	803034	42
134516	803008	27
134519	802011	17
134525	803011	30
134526	802021	10
134541	802017	9
134548	803041	45
134552	802019	8
134555	802019	8
134557	802019	8
134558	802019	8
134562	803008	27
134612	803007	46
134613	803007	46
134633	803007	46
134656	802021	10
134658	803010	28
134659	803010	28
134660	803010	28
134661	803010	28
134664	802004	14
134665	803015	31
134668	802004	14
134669	802004	14
134671	802008	13
134673	803036	43
134692	803007	46
134699	803034	42
134702	803010	28
134716	803007	46
134717	802008	13
134718	802008	13
134719	802008	13
134720	802003	15
134721	802003	15
134727	802015	12
134730	802015	12
134739	803022	35
134740	803022	35
134756	803034	42
134760	802005	15
134766	802005	15
134767	802005	15
134768	802003	15
134774	802017	9
134775	802017	9
134776	803007	46
134779	803034	42
134781	802013	14

Cargo	Assortments	Page
134788	803030	40
134790	803034	42
134791	803034	42
134843	803015	31
134851	803028	38
134867	803031	40
134870	802001	9
134902	803034	42
or	803041	45
134921	803006	47
134931	803007	46
134937	803041	45
134948	803028	38
134949	803028	38
134950	803028	38
134951	803028	38
134952	803028	38
134957	803026	36
134958	803040	45
134959	803040	45
134964	802017	9
134965	803007	46
134980	803034	42
134992	803031	40
134993	803028	38
134994	803031	40
134995	803028	38
134996	802008	13
134998	802004	14
134999	802008	13
135000	802008	13
135001	802004	14
135004	803041	45
135005	802020	10
135014	803034	42
135017	803036	43
135018	803034	42
or	803041	45
135023	802024	17
135025	802024	17
135026	802024	17
135037	802030	11
135049	802028	23
135050	803040	45
135051	803040	45
135052	803040	45
135053	803040	45
135054	802032	18
135055	803040	45
135060	802019	8
135061	802017	9
135062	803040	45
135066	803026	36
135103	803036	43
135104	803036	43
135105	803036	43
135106	803036	43
135108	803036	43
135119	803026	36
135122	803026	36
135127	803031	40
135128	803031	40
135129	802007	11
135130	802007	11
135131	802007	11
135132	802009	13
135133	802009	13
135134	802009	13
135135	802005	15

Cargo	Assortments	Page
135136	802005	15
135137	803036	43
135140	802008	13
or	802032	18
135152	802011	17
135153	802011	17
135166	803031	40
135167	803031	40
135168	803031	40
135169	802014	16
135170	802034	22
135171	802034	22
135172	802019	8
135173	802003	15
or	802032	18
135174	802019	8
135199	803039	46
135201	803028	38
or	803041	45
135211	802017	9
135213	802011	17
135216	802017	9
135237	802019	8
or	802034	22
135259	803040	45
135299	803041	45
135315	802032	18
135317	803034	42
135326	803034	42
135363	803036	43
135368	803028	38
135372	803039	46
135384	803004	39
135385	803004	39
135407	802034	22
135422	803041	45
135453	802007	11
135460	803041	45
135508	802034	22
135575	803039	46
135579	803039	46
135642	803039	46
135770	803041	45
135851	803039	46
135879	803040	45
135940	803039	46
135957	802008	13
135968	803040	45
135969	803040	45
136014	802029	21
136016	802029	21
136235	802034	22
136284	802024	17
136665	803039	46
136694	803041	45
136791	803039	46
136873	802007	11
136946	803041	45
136947	803041	45
137046	802009	13
137165	803040	45
137177	803039	46
137348	803035	42
137590	803040	45
137591	803040	45
137594	803040	45
137700	803041	45
137803	802029	21
137841	802030	11

Index for Assortments

Cargo	Assortments	Page
138073	802033	8
138121	803039	46
138130	802029	21
138203	802033	8
138282	802033	8
138369	802029	21
138441	802032	18
138639	803041	45
138807	802033	8
138927	803011	30
139046	803004	39
139047	803004	39
139281	802033	8
139494	803004	39
139532	803004	39
139681	802034	22
139929	802034	22
139952	802034	22
139955	803036	43
139964	802007	11
140003	803012	29
140004	803012	29
140008	803012	29
140009	803012	29
or.....	803020	33
140010	803012	29
140011	803011	30
140012	803012	29
140016	803012	29
140017	803012	29
140018	803012	29
140019	803012	29
140020	803012	29
140025	803012	29
140026	803012	29
140027	803012	29
140028	803012	29
140029	803012	29
140030	803012	29
140035	803012	29
140038	803019	32
140040	803019	32
or.....	803025	36
140041	803019	32
140042	803019	32
140043	803019	32
or.....	803020	33
or.....	803033	41
140046	803020	33
140047	803020	33
140048	803020	33
140049	803020	33
140050	803020	33
140053	803025	36
140056	803025	36
140057	803025	36
140058	803025	36
140064	803019	32
or.....	803033	41
140065	803033	41
140066	803033	41
140070	803014	30
140071	803014	30
140072	803014	30
140093	802030	11
140103	803025	36
140105	802025	20
140106	802025	20
140109	803020	33

Cargo	Assortments	Page
140110	803020	33
140111	803011	30
140115	802001	9
or.....	802025	20
140116	802015	12
or.....	802025	20
140119	803033	41
140120	802016	12
or.....	802020	10
or.....	802021	10
or.....	802025	20
140131	802010	22
140132	802010	22
140133	802010	22
140134	802020	10
140135	802020	10
140140	803012	29
140144	803025	36
140151	803012	29
140157	803019	32
140158	803025	36
140161	802016	12
140164	803005	44
140174	803020	33
140176	802025	20
140181	803014	30
140182	803014	30
140183	803014	30
140184	803014	30
140185	803014	30
140197	803011	30
140198	803011	30
140200	803020	33
140201	803020	33
140202	803020	33
140203	803012	29
140204	803012	29
140206	803014	30
140208	803012	29
140211	803020	33
140212	803025	36
140214	803014	30
140215	803014	30
140217	803014	30
140221	803020	33
140222	802026	20
or.....	803013	47
or.....	803022	35
or.....	803042	44
140223	803013	47
or.....	803022	35
or.....	803042	44
140224	803013	47
140225	803013	47
or.....	803022	35
or.....	803042	44
140226	803013	47
or.....	803022	35
or.....	803042	44
140227	803013	47
or.....	803022	35
140231	802002	19
140232	802002	19
140233	802002	19
140234	802002	19
140235	802002	19
140236	802002	19
140237	802002	19
140239	802002	19

Cargo	Assortments	Page
140240	802016	12
or.....	802025	20
140242	802035	21
or.....	803013	47
or.....	803026	36
140243	802010	22
140244	802010	22
140245	802010	22
140246	802010	22
140247	802010	22
140249	803012	29
140250	803012	29
140251	803012	29
140252	803012	29
140257	803019	32
140258	803033	41
140259	803033	41
140261	803012	29
140263	802025	20
140264	803019	32
140265	802015	12
or.....	802025	20
140266	802025	20
140267	803019	32
140268	803020	33
140269	803020	33
140270	803020	33
140272	803042	44
140273	803042	44
140296	802026	20
140300	802026	20
140301	802026	20
or.....	803042	44
140305	803002	34
140306	803002	34
140307	803002	34
140308	803002	34
140309	803002	34
140310	803002	34
or.....	803042	44
140311	803002	34
or.....	803042	44
140312	803002	34
140313	803002	34
or.....	803042	44
140314	803002	34
or.....	803020	33
or.....	803042	44
140315	803002	34
140316	803002	34
140317	803002	34
or.....	803042	44
140318	803002	34
140319	803003	37
140319	803042	44
140320	803003	37
or.....	803042	44
140321	803003	37
or.....	803042	44
140322	803003	37
140323	803003	37
140324	803003	37
140325	803001	39
or.....	803042	44
140326	803001	39
or.....	803042	44
140327	803001	39
140328	803001	39
or.....	803042	44

Index for Assortments

Cargo	Assortments	Page
140329	803001	39
140330	803001	39
140331	803001	39
140332	803001	39
140333	803001	39
or	803042	44
140334	803023	34
or	803038	43
140335	803023	34
140336	803023	34
or	803038	43
140337	803023	34
140338	803023	34
or	803038	43
140339	803023	34
140340	803023	34
140341	803023	34
140342	802027	19
or	802031	18
140343	802027	19
or	802031	18
140345	803027	37
140346	803027	37
140347	803027	37
or	803038	43
140348	803027	37
140349	803027	37
or	803038	43
140351	802027	19
or	802031	18
140352	802008	13
or	802027	19
140353	802027	19
or	802031	18
140354	802008	13
or	802027	19
140356	803029	38
140357	803029	38
140358	803029	38
140359	803029	38
140360	803029	38
140361	803029	38
or	803038	43
140362	803029	38
or	803038	43
140363	803029	38
or	803038	43
140364	803029	38
or	803038	43
140365	802003	15
or	802027	19
or	802031	18
140367	802027	19
or	802031	18
140368	802004	14
or	802027	19
140369	802004	14
or	802027	19
or	802031	18
140370	802003	15
or	802027	19
140371	802027	19
140374	803020	33
140375	802035	21
or	803013	47
140376	803023	34
140377	803023	34
140378	803023	34
or	803038	43

Cargo	Assortments	Page
140379	803023	34
or	803038	43
140380	802027	19
or	802030	11
or	802031	18
140381	803013	47
or	803022	35
140386	803027	37
140387	803027	37
or	803038	43
140388	803027	37
140393	803029	38
140395	803027	37
140396	803029	38
140398	803006	47
140399	803006	47
140400	803006	47
140401	802025	20
140404	803014	30
140405	803014	30
140406	803014	30
140408	803005	44
140410	803005	44
140412	803013	47
or	803042	44
140417	802002	19
140419	802002	19
140420	802002	19
140421	802035	21
140423	803012	29
140424	803001	39
140425	803001	39
or	803042	44
140426	803001	39
or	803042	44
140427	803001	39
or	803042	44
140428	803003	37
or	803042	44
140429	803003	37
or	803042	44
140430	803003	37
or	803042	44
140432	802002	19
140434	802002	19
or	802030	11
140437	802008	13
or	802027	19
or	802031	18
140438	802019	8
140439	802019	8
140440	803033	41
140441	802002	19
140442	802025	20
140443	802002	19
140444	802016	12
140457	803013	47
or	803022	35
140459	802026	20
140460	802002	19
140461	802002	19
140462	802002	19
140466	803003	37
or	803042	44
140468	802035	21
or	803013	47
140470	803013	47
140473	803033	41
140474	803033	41

Cargo	Assortments	Page
140477	803014	30
140478	803014	30
140480	803024	35
140481	803024	35
140482	802035	21
140483	802035	21
140484	803003	37
140489	803002	34
or	803042	44
140494	802035	21
or	803013	47
140495	802035	21
140496	803033	41
140497	803033	41
140498	803033	41
140499	803033	41
140500	803012	29
140504	802010	22
140505	803003	37
or	803042	44
140509	803024	35
140511	803024	35
140513	803024	35
140514	802035	21
or	803013	47
140515	802025	20
140516	802025	20
140523	802026	20
140524	802019	8
140526	803033	41
140528	803025	36
140531	803033	41
140533	803019	32
or	803033	41
140537	803033	41
140540	803033	41
140541	803033	41
140543	803019	32
140544	803019	32
140545	803019	32
140552	802035	21
140554	803001	39
140555	803003	37
or	803042	44
140556	803027	37
or	803038	43
140559	803027	37
or	803038	43
140560	803027	37
140563	803012	29
140566	803029	38
140567	803023	34
or	803038	43
140568	803027	37
140569	802025	20
140570	803029	38
140572	803002	34
140573	803002	34
140576	802027	19
140577	802027	19
140579	803001	39
140580	803002	34
140581	803003	37
140582	803001	39
140583	803001	39
140584	803002	34
140585	803003	37
140586	803003	37
140587	803003	37

Index for Assortments

Cargo	Assortments	Page
140588	802002	19
140589	802002	19
140591	803027	37
140595	803023	34
140597	803023	34
140598	802021	10
140601	803014	30
140602	803029	38
140608	802010	22
140609	802010	22
140610	802010	22
140611	802010	22
140612	802010	22
140613	802016	12
140614	803020	33
140615	803033	41
140616	802010	22
140617	802035	21
140618	803002	34
140619	802035	21
140620	802035	21
140621	803019	32
140622	803019	32
140623	803019	32
140626	803020	33
140629	803003	37
140630	803013	47
140635	802026	20
140645	803012	29
140647	803029	38
140651	802010	22
140653	803020	33
140654	803020	33
140656	803025	36
140657	803025	36
140658	803025	36
140659	803025	36
140661	803025	36
140663	803025	36
140667	803019	32
140684	803033	41
140690	803020	33
140694	803003	37
140695	803003	37
140697	803001	39
140699	802010	22
140700	802010	22
140701	802010	22
140702	802010	22
140703	802010	22
140704	803006	47
140708	803027	37
or.....	803038	43
140709	803027	37
140710	803020	33
140718	802010	22
140719	802010	22
140720	802010	22
140721	802010	22
140722	802010	22
140731	803003	37
or.....	803042	44
140738	802035	21
140739	802010	22
140740	803029	38
140751	802035	21
140752	802035	21
140767	802035	21
140768	802035	21

Cargo	Assortments	Page
140776	803014	30
140779	803003	37
140787	803001	39
140788	803001	39
140804	803003	37
140807	802035	21
140846	803003	37
140849	803037	32
140876	802035	21
140903	802035	21
140904	802035	21
140908	803003	37
140919	802035	21
140935	802035	21
140944	803014	30
141001	802035	21
141039	802035	21
141054	802035	21
141090	802035	21
141168	802035	21
141209	802035	21
141219	802035	21
150055	810001	129
150056	810001	129
150057	810001	129
150062	810001	129
150063	810001	129
150064	810001	129
150068	810002	129
150071	810001	129
150075	810001	129
150088	810001	129
150091	810002	129
150109	810006	130
150124	810006	130
150150	810006	130
150157	810002	129
150160	810002	129
150168	810002	129
150175	810001	129
150234	810002	129
150235	810002	129
150236	810002	129
150308	810006	130
150309	810006	130
150321	810006	130
150323	810006	130
150324	810006	130
150332	810007	130
150336	810007	130
150340	810007	130
150343	810007	130
150354	810007	130
150361	810007	130
150366	810007	130
150377	810002	129
150378	810002	129
150384	810001	129
150398	810002	129
150402	810006	130
150404	810007	130
150503	802035	21
160080	811001	133
or.....	811002	133
160081	811001	133
or.....	811002	133
160082	811002	133
or.....	811003	134
160083	811001	133

Cargo	Assortments	Page
or.....	811002	133
160115	811005	135
160116	811005	135
160155	811001	133
or.....	811002	133
160168	811001	133
or.....	811002	133
160169	811002	133
or.....	811003	134
160215	811002	133
or.....	811003	134
160216	811002	133
or.....	811003	134
160239	811001	133
or.....	811002	133
160240	811002	133
or.....	811003	134
160242	811005	135
160243	811005	135
160244	811005	135
160263	811005	135
160265	811001	133
or.....	811002	133
160266	811002	133
or.....	811003	134
160268	811003	134
160270	811001	133
or.....	811002	133
160271	811002	133
or.....	811003	134
160272	811002	133
or.....	811003	134
160282	811001	133
or.....	811002	133
160305	811005	135
160307	811002	133
or.....	811003	134
160308	811001	133
160311	811002	133
160312	811005	135
160314	811005	135
160315	811005	135
160316	811002	133
160317	811002	133
or.....	811003	134
160337	811003	134
160341	811005	135
160363	811004	134
160364	811004	134
160365	811004	134
160366	811004	134
160367	811004	134
160368	811004	134
160402	811005	135
160403	811001	133
160468	811001	133
160473	811002	133
160474	811005	135
160475	811005	135
160479	811002	133
160480	811002	133
160521	811004	134
162089	804103	57
170005	809002	122
170074	803014	30
170135	809001	121
170136	809001	121
170137	809001	121
170138	809001	121

Index for Assortments

Cargo	Assortments	Page
170139	809001	121
170331	809003	122
	809005	123
<i>or</i>	809007	124
170335	809008	121
170336	809008	121
170339	809008	121
170340	809008	121
170341	809002	122
170343	809002	122
170344	809002	122
170345	809006	124
170346	809006	124
170347	809003	122
<i>or</i>	809005	123
<i>or</i>	809007	124
170357	809003	122
<i>or</i>	809005	123
<i>or</i>	809007	124
170358	809004	125
<i>or</i>	809007	124
170364	809003	122
<i>or</i>	809005	123
<i>or</i>	809007	124
170410	809003	122
<i>or</i>	809005	123
<i>or</i>	809007	124
170411	809002	122
170433	809001	121
170448	809006	124
170476	809004	125
<i>or</i>	809007	124
170477	809004	125
<i>or</i>	809007	124
170542	809004	125
<i>or</i>	809007	124
170545	809003	122
<i>or</i>	809005	123
<i>or</i>	809007	124
170588	809002	122
170590	809002	122
170591	809002	122
170594	809006	124
170596	809001	121
170610	809003	122
<i>or</i>	809005	123
<i>or</i>	809007	124
170611	809003	122
<i>or</i>	809005	123
<i>or</i>	809007	124
170612	809003	122
<i>or</i>	809005	123
<i>or</i>	809007	124
170613	809004	125
<i>or</i>	809007	124
170617	809003	122
<i>or</i>	809005	123
<i>or</i>	809007	124
170619	809001	121
170684	809004	125
<i>or</i>	809007	124
170698	809003	122
<i>or</i>	809005	123
170725	809006	124
170727	809005	123
170731	809005	123
170732	809005	123
170751	809005	123
170752	809005	123

Cargo	Assortments	Page
170753	809005	123
170754	809005	123
170755	809005	123
170756	809005	123
170757	809005	123
170758	809005	123
170762	809005	123
170763	809001	121
170778	809006	124
170779	809006	124
170780	809006	124
170781	809006	124
170782	809006	124
170783	809006	124
170784	809006	124
170785	809006	124
170786	809006	124
170790	809001	121
170791	809001	121
170799	809001	121
170805	809004	125
170806	809004	125
170807	809004	125
170808	809004	125
170810	809008	121
170811	809008	121
170812	809008	121
170814	809008	121
170815	809008	121
170816	809008	121
170822	809006	124
170827	809001	121
170948	809006	124
170972	809005	123
171023	809009	123
171024	809009	123
171025	809004	125
171026	809004	125
171027	809004	125
171028	809004	125
171029	809004	125
171031	809009	123
171032	809004	125
171033	809009	123
171284	809009	123
171379	809009	123
171380	809009	123
171381	809009	123
171382	809009	123
171383	809009	123
171384	809009	123
171385	809009	123
171387	809009	123
171388	809009	123
171389	809009	123
171391	809009	123
180008	808001	116
180009	808001	116
180018	808003	111
180021	808003	111
180022	808003	111
180023	808003	111
180036	808003	111
180048	808003	111
180088	808003	111
180089	808003	111
180091	808003	111
180092	808003	111
180094	808003	111

Cargo	Assortments	Page
180096	810002	129
180098	810001	129
180103	808003	111
180104	808003	111
180123	808003	111
180140	808003	111
180141	808003	111
180156	808003	111
180158	808003	111
180176	808003	111
180177	808003	111
180178	808003	111
180179	808003	111
180180	808003	111
180222	808002	111
180245	804017	51
180254	808002	111
180255	808002	111
180262	808002	111
180263	808002	111
180265	808002	111
180266	808002	111
180267	808002	111
180268	808002	111
180269	808002	111
180334	808004	113
<i>or</i>	808005	113
<i>or</i>	808007	114
180335	808004	113
<i>or</i>	808005	113
<i>or</i>	808007	114
180336	808004	113
<i>or</i>	808005	113
<i>or</i>	808007	114
180337	808004	113
<i>or</i>	808005	113
<i>or</i>	808007	114
180355	808005	113
<i>or</i>	808006	114
180356	808005	113
<i>or</i>	808006	114
180357	808005	113
<i>or</i>	808006	114
180358	808005	113
<i>or</i>	808006	114
180526	808004	113
180584	808014	112
180585	808014	112
180586	808014	112
180587	808014	112
180588	808014	112
180589	808014	112
180590	808014	112
180591	808014	112
180592	808014	112
180593	808014	112
180594	808014	112
180595	808014	112
180597	808015	112
180598	808015	112
180599	808015	112
180600	808015	112
180601	808015	112
180625	808002	111
180627	808015	112
180628	808015	112
180630	808008	115
180631	808008	115
180634	808008	115

Index for Assortments

Cargo	Assortments	Page
180635	808008	115
180636	808008	115
180638	808008	115
180639	808008	115
180640	808008	115
180641	808008	115
180645	808008	115
180648	808008	115
180649	808008	115
180650	808008	115
180651	808008	115
180653	808008	115
180654	808008	115
180655	808008	115
180656	808008	115
180657	808008	115
180658	808008	115
180660	808008	115
180661	808008	115
180662	808008	115
180672	808008	115
180673	808008	115
180674	808008	115
180677	808008	115
180678	808008	115
180679	808008	115
180682	808008	115
180688	808008	115
180697	808008	115
180702	808009	115
180704	808009	115
180705	808009	115
180706	808009	115
180707	808009	115
180712	808009	115
180714	808009	115
180715	808009	115
180726	808001	116
180727	808001	116
180728	808001	116
180729	808001	116
180730	808001	116
180731	808001	116
180734	808001	116
180735	808001	116
180736	808001	116
180738	808001	116
180740	808001	116
180747	808001	116
180749	808001	116
180753	808001	116
180760	808001	116
180790	808001	116
180791	808001	116
180804	808012	116
180805	808012	116
180807	808012	116
180808	808012	116
180810	808012	116
180811	808012	116
180812	808012	116
180814	808012	116
180820	808012	116
180824	808012	116
180826	808012	116
180827	808012	116
180829	808012	116
180830	808012	116
180832	808012	116

Cargo	Assortments	Page
180833	808012	116
180834	808012	116
180835	808012	116
180837	808012	116
180838	808012	116
180839	808012	116
180840	808012	116
180841	808012	116
180842	808012	116
180846	808012	116
180848	808012	116
180861	808012	116
<i>or</i>	808016	117
180868	808016	117
180869	808012	116
180871	808012	116
180872	808012	116
180873	808016	117
180874	808016	117
180875	808016	117
180877	808012	116
180879	808012	116
180881	808016	117
180883	808016	117
180884	808016	117
180887	808016	117
180893	808016	117
180895	808016	117
180896	808016	117
180897	808016	117
180905	808016	117
180906	808016	117
180919	808016	117
180945	808011	117
180946	808011	117
180949	808011	117
180950	808011	117
180951	808011	117
180953	808011	117
180954	808011	117
180958	808011	117
180959	808011	117
180963	808011	117
180973	808011	117
180979	808011	117
180980	808011	117
180981	808011	117
180983	808011	117
180985	808011	117
181001	808013	118
181005	808013	118
181006	808013	118
181008	808013	118
181009	808013	118
181015	808013	118
181017	808013	118
181018	808013	118
181021	808013	118
181060	808013	118
181062	808013	118
181064	808013	118
181065	808013	118
181073	808013	118
181076	808013	118
181077	808013	118
181085	808013	118
181088	808013	118
181089	808013	118
181090	808013	118

Cargo	Assortments	Page
181098	808013	118
181105	808013	118
181121	808013	118
181126	808013	118
181133	808013	118
181141	808013	118
181147	808010	118
181148	808010	118
181150	808010	118
181152	808010	118
181156	808010	118
181158	808010	118
181160	808010	118
181163	808010	118
181165	808010	118
181172	808010	118
181179	808010	118
181182	808010	118
181183	808010	118
181191	808010	118
181194	808010	118
181196	808010	118
181197	808010	118
181200	808010	118
181201	808010	118
181205	808010	118
181212	808010	118
181214	808010	118
181407	804016	62
190001	804014	53
<i>or</i>	804049	52
<i>or</i>	804093	54
<i>or</i>	804095	53
190005	804040	79
190006	804040	79
190007	804040	79
190008	804040	79
190009	804040	79
190010	804040	79
190012	804089	64
190013	804089	64
190014	804024	78
190015	804015	54
<i>or</i>	804048	51
190016	804014	53
<i>or</i>	804049	52
<i>or</i>	804093	54
<i>or</i>	804095	53
190017	804014	53
<i>or</i>	804048	51
<i>or</i>	804093	54
<i>or</i>	804095	53
190018	804014	53
<i>or</i>	804049	52
<i>or</i>	804095	53
190019	804014	53
<i>or</i>	804048	51
<i>or</i>	804093	54
<i>or</i>	804095	53
190020	804014	53
<i>or</i>	804049	52
<i>or</i>	804093	54
<i>or</i>	804095	53
190021	804014	53
<i>or</i>	804048	51
<i>or</i>	804093	54
<i>or</i>	804095	53
190022	804014	53
<i>or</i>	804048	51

Index for Assortments

Cargo	Assortments	Page
or.....	804093	54
or.....	804095	53
190023	804014	53
or.....	804049	52
or.....	804095	53
190024	804014	53
or.....	804050	52
or.....	804093	54
190025	804014	53
or.....	804048	51
190026	804014	53
or.....	804049	52
or.....	804093	54
or.....	804095	53
190027	804015	54
or.....	804048	51
190028	804014	53
or.....	804048	51
or.....	804093	54
or.....	804095	53
190029	804015	54
or.....	804049	52
190030	804050	52
or.....	804093	54
190031	804015	54
or.....	804048	51
or.....	804093	54
190032	804015	54
or.....	804049	52
or.....	804093	54
190033	804015	54
or.....	804050	52
190034	804015	54
or.....	804049	52
or.....	804095	53
190035	804015	54
or.....	804050	52
190035	804093	54
190037	804015	54
or.....	804049	52
or.....	804093	54
190038	804015	54
or.....	804048	51
190039	804015	54
or.....	804049	52
190041	804014	53
or.....	804049	52
190042	804015	54
or.....	804050	52
or.....	804093	54
190045	804014	53
or.....	804048	51
190046	804014	53
or.....	804049	52
or.....	804093	54
or.....	804095	53
190048	804014	53
or.....	804050	52
or.....	804095	53
190049	804014	53
or.....	804048	51
190050	804050	52
or.....	804093	54
190051	804050	52
or.....	804093	54
190053	804008	66
190054	804008	66
190055	804008	66
or.....	804097	67

Cargo	Assortments	Page
190056	804008	66
or.....	804097	67
or.....	804098	68
190057	804008	66
or.....	804097	67
or.....	804098	68
190058	804008	66
or.....	804097	67
or.....	804098	68
190059	804008	66
or.....	804097	67
or.....	804098	68
or.....	804008	66
190060	804097	67
190061	804008	66
or.....	804097	67
or.....	804098	68
or.....	804008	66
190060	804097	67
190061	804008	66
or.....	804097	67
or.....	804098	68
190080	804075	60
190110	804022	78
190111	804022	78
190112	804022	78
190114	804022	78
190115	804022	78
190116	804022	78
190120	804022	78
190122	804022	78
190142	804093	54
190188	804024	78
190202	804089	64
190203	804089	64
190213	804089	64
190214	804089	64
190248	804024	78
190252	804013	56
or.....	811004	134
190255	804015	54
or.....	804050	52
or.....	804095	53
190256	804013	56
190257	804015	54
or.....	804049	52
190259	802019	8
190260	804012	59
190261	804012	59
190262	804012	59
190263	804012	59
190264	804012	59
190265	804012	59
190266	804012	59
190267	804012	59
190270	804013	56
190272	804012	59
190273	804033	73
190274	804036	66
190275	804036	66
190276	804036	66
190277	804036	66
190278	804036	66
190279	804036	66
190280	804036	66
190284	804036	66
190285	804036	66
190286	804036	66
190287	804036	66
190288	804036	66
190289	804036	66
190308	802004	14
190360	804069	79
190361	804069	79

Cargo	Assortments	Page
190362	804069	79
190366	804069	79
190367	804069	79
190368	804069	79
190371	804069	79
190372	804069	79
190373	804069	79
190477	815032	154
190478	815032	154
190520	804028	81
or.....	804037	81
190521	804028	81
or.....	804037	81
190524	804028	81
190525	804028	81
190527	804028	81
190531	804037	81
190536	804037	81
190540	804037	81
190541	804037	81
190544	804037	81
190547	804037	81
190552	804037	81
190580	815032	154
190603	804107	62
190632	806017	98
or.....	806022	98
190633	806022	98
190634	806022	98
190638	806017	98
or.....	806022	98
190697	804078	74
190698	804078	74
190699	804078	74
190700	804078	74
190702	804078	74
190716	804054	57
190717	804054	57
190718	804054	57
or.....	804104	72
190719	804054	57
or.....	804104	72
190720	804054	57
190721	804054	57
190722	804054	57
190723	804054	57
190725	804013	56
190726	804013	56
190734	804036	66
190735	804036	66
190736	804036	66
190762	802019	8
190768	804033	73
190770	804033	73
190779	804028	81
or.....	804037	81
190780	804028	81
or.....	804037	81
190782	804028	81
190787	804033	73
190806	802007	11
or.....	802009	13
or.....	804020	82
or.....	806016	96
190807	804020	82
190808	804020	82
or.....	806016	96
190809	804020	82
or.....	806016	96

Index for Assortments

Cargo	Assortments	Page
190810	804020	82
190811	804020	82
190812	804020	82
or	806016	96
190813	804020	82
190815	802005	15
or	802009	13
or	804020	82
or	806016	96
190816	804020	82
190817	804020	82
or	806016	96
190818	802007	11
or	804020	82
190819	802005	15
or	804020	82
190820	802005	15
or	802009	13
or	804020	82
190821	804020	82
190822	804020	82
190823	804020	82
190824	804020	82
190826	804020	82
or	806016	96
190828	804020	82
or	806016	96
190843	804012	59
190846	804054	57
190866	804089	64
190867	804089	64
190868	804013	56
or	811004	134
190870	804033	73
190886	804062	76
190887	804062	76
190888	804062	76
190889	804062	76
190890	804062	76
190891	804062	76
190899	804021	77
190900	804021	77
190901	804021	77
190902	804021	77
190903	804021	77
190904	804021	77
190905	804021	77
190906	804021	77
190907	804021	77
190908	804021	77
190909	804021	77
190937	804040	79
190938	804040	79
190952	804015	54
or	804049	52
or	804093	54
190953	804015	54
or	804050	52
or	804093	54
190957	804033	73
190958	804022	78
190959	804022	78
190964	804022	78
190965	804022	78
190966	804022	78
190967	804022	78
190968	804022	78
190969	804022	78
190970	804022	78

Cargo	Assortments	Page
190973	804015	54
or	804048	51
or	804093	54
190974	804015	54
or	804048	51
190985	804014	53
or	804048	51
or	804093	54
or	804095	53
191001	804033	73
191003	804024	78
191007	804012	59
191008	804013	56
191009	804014	53
or	804048	51
or	804055	55
191010	804014	53
or	804049	52
or	804055	55
191011	804014	53
or	804050	52
or	804055	55
191025	804013	56
or	804082	63
191028	804013	56
191029	804013	56
191053	804033	73
191054	804033	73
191055	804033	73
191064	804013	56
191067	804015	54
or	804049	52
191069	804013	56
191074	804092	56
191075	804092	56
191078	804092	56
191079	804092	56
191083	804013	56
or	804103	57
191089	804013	56
or	804103	57
or	811004	134
191091	804092	56
191092	804092	56
191094	804024	78
191126	804012	59
191127	804012	59
191128	804024	78
191129	804013	56
or	804103	57
191152	804032	70
or	804052	69
or	804076	70
or	804098	68
191153	804032	70
or	804052	69
or	804076	70
or	804098	68
191154	804032	70
or	804052	69
or	804076	70
or	804098	68
191155	804032	70
or	804052	69
or	804076	70
191156	804032	70
or	804052	69
or	804076	70
191157	804032	70
or	804052	69

Cargo	Assortments	Page
or	804076	70
191158	804012	59
191159	804012	59
191168	804017	51
191169	804017	51
191171	804017	51
191172	804017	51
191184	804032	70
191185	804032	70
191186	804032	70
191187	804032	70
191188	804032	70
191189	804032	70
191190	804033	73
191191	804050	52
191196	804017	51
191197	804017	51
191200	804013	56
or	809001	121
191224	804012	59
191225	804012	59
191226	804012	59
191227	804012	59
191246	804016	62
191247	804016	62
191248	804016	62
191249	804032	70
or	804099	69
or	804106	68
191250	804032	70
or	804097	67
or	804099	69
or	804106	68
191251	804032	70
or	804097	67
or	804099	69
or	804106	68
191252	804032	70
or	804097	67
or	804099	69
or	804106	68
191253	804032	70
or	804097	67
or	804099	69
or	804106	68
191254	804032	70
or	804099	69
or	804106	68
191255	804032	70
or	804099	69
or	804106	68
191256	804032	70
or	804106	68
191257	804033	73
191258	804033	73
191259	804033	73
or	814105	74
191260	804016	62
or	804033	73
191261	804016	62
or	804033	73
191262	804016	62
or	804033	73
191263	804016	62
191264	804016	62
191266	804029	80
191270	804068	83
191271	804068	83
191272	804068	83

Index for Assortments

Cargo	Assortments	Page
191273	804068	83
191274	804068	83
191275	804068	83
191276	804068	83
191277	804068	83
191278	804068	83
191279	804068	83
191280	804068	83
191292	802019	8
or	804029	80
191298	802003	15
or	802004	14
or	802028	23
191299	802028	23
191302	804028	81
191303	804028	81
191304	804028	81
191306	804028	81
191307	802021	10
or	804028	81
191308	802003	15
or	804028	81
191317	804037	81
191318	804037	81
191319	804037	81
191326	804029	80
191327	804029	80
191328	804029	80
191329	804029	80
191330	804029	80
191333	804068	83
191339	804019	82
191340	804019	82
191341	804019	82
191342	804019	82
191343	804019	82
191344	804019	82
191345	804019	82
191346	804019	82
191347	804019	82
191348	804019	82
191349	804019	82
191350	804019	82
191351	804019	82
191352	804019	82
191353	804019	82
191354	804019	82
191355	804019	82
191356	804019	82
191357	804019	82
191358	802009	13
or	804020	82
191364	804041	84
191365	804041	84
191366	804041	84
191367	804041	84
191368	804041	84
191369	804041	84
191370	804041	84
191371	804041	84
191372	804041	84
191373	804041	84
191374	804041	84
191375	804041	84
191376	804041	84
191405	804016	62
191406	804016	62
191408	804016	62
191411	804013	56

Cargo	Assortments	Page
191412	804013	56
191413	804013	56
191415	804013	56
191416	804054	57
191416	804104	72
191417	804021	77
191430	804019	82
191432	804029	80
191433	804068	83
191434	804019	82
191435	804029	80
191442	804019	82
191444	804019	82
191465	804008	66
or	804096	67
191466	804008	66
or	804096	67
191467	804008	66
or	804096	67
191468	804008	66
or	804096	67
or	804097	67
191469	804008	66
or	804096	67
or	804097	67
or	804098	68
191470	804008	66
or	804096	67
or	804097	67
or	804098	68
191471	804008	66
or	804096	67
or	804097	67
or	804098	68
191472	804008	66
or	804096	67
or	804097	67
or	804098	68
191473	804008	66
or	804096	67
or	804097	67
191474	804008	66
or	804096	67
or	804097	67
or	804098	68
191475	804008	66
191476	804008	66
191480	804041	84
191481	804068	83
191486	804029	80
191489	804020	82
191489	806016	96
191490	804020	82
191496	804016	62
191501	804048	51
191513	804028	81
191514	804029	80
191515	804050	52
191528	804029	80
191530	803031	40
or	804029	80
191531	803031	40
or	804029	80
191534	804036	66
191539	804029	80
191543	804092	56
191544	804092	56
191551	804080	61
or	804103	57

Cargo	Assortments	Page
191563	804092	56
191564	804092	56
191570	804036	66
191573	804068	83
191575	806017	98
or	806022	98
191576	806022	98
191577	806017	98
or	806022	98
191587	806017	98
or	806022	98
191628	804052	69
or	804076	70
or	804098	68
191629	804052	69
or	804076	70
or	804098	68
191630	804052	69
or	804076	70
or	804098	68
191631	804052	69
or	804076	70
191632	804052	69
or	804076	70
191633	804052	69
or	804076	70
191634	804052	69
or	804076	70
191635	804052	69
or	804076	70
191636	804052	69
or	804076	70
191637	804052	69
or	804076	70
191638	804052	69
or	804076	70
191652	804062	76
191664	804008	66
191670	804036	66
191672	804076	70
191673	804076	70
191681	804103	57
191682	804055	55
191683	804055	55
191684	804055	55
191685	804055	55
191686	804055	55
191687	804055	55
191688	804055	55
191689	804055	55
191690	804055	55
191691	804055	55
191692	804055	55
191693	804055	55
191694	804055	55
191695	804055	55
191696	804055	55
191697	804055	55
191698	804055	55
191699	804055	55
191700	804055	55
191701	804056	55
191702	804056	55
191703	804056	55
191704	804056	55
191705	804056	55
191706	804056	55
191707	804056	55
191708	804056	55

Index for Assortments

Cargo	Assortments	Page
191709	804056	55
191710	804056	55
191711	804056	55
191712	804056	55
191713	804056	55
191714	804056	55
191715	804056	55
191716	804056	55
191717	804083	63
191718	804083	63
191719	804083	63
191721	804083	63
191722	804082	63
191723	804082	63
191724	804082	63
191725	804082	63
191726	804082	63
191727	804082	63
or	804083	63
191728	804083	63
191729	804083	63
191730	804083	63
191731	804082	63
191732	804083	63
191733	804083	63
191735	804083	63
191737	804082	63
191738	804082	63
191739	804083	63
191740	804083	63
191741	804083	63
191742	804083	63
191743	804083	63
191744	804083	63
191745	804083	63
191746	804083	63
191752	811004	134
191753	804069	79
191764	804082	63
191765	804082	63
191766	804082	63
191767	804082	63
191770	804037	81
191775	804106	68
191798	804069	79
191806	804103	57
191807	804103	57
191819	804074	64
191820	804074	64
191821	804074	64
191822	804074	64
191823	804074	64
191824	804074	64
191826	804074	64
191830	804076	70
or	804098	68
191831	804076	70
or	804098	68
191832	804076	70
191833	804076	70
191834	804076	70
191836	804061	58
191837	804061	58
191838	804061	58
191839	804061	58
191840	804061	58
191841	804061	58
191842	804061	58
191843	804061	58

Cargo	Assortments	Page
191844	804061	58
191845	804061	58
191846	804061	58
191847	804061	58
191848	804061	58
191849	804061	58
191850	804061	58
191851	804061	58
191852	804061	58
191853	804061	58
191857	804064	84
191858	804064	84
191859	804064	84
191860	804064	84
191861	804064	84
191862	804065	83
191863	804065	83
191864	804065	83
191865	804065	83
191866	804065	83
191870	814105	74
191871	814105	74
191872	814105	74
191874	804077	75
191875	804077	75
191876	804077	75
191877	804077	75
191878	804077	75
191879	804077	75
191880	804077	75
191885	804073	58
191886	804073	58
191887	804073	58
191888	804073	58
191889	804073	58
191890	804073	58
191891	804073	58
191892	804101	76
191893	804101	76
191894	804101	76
191895	804101	76
191896	804101	76
191897	804101	76
191905	804062	76
191906	804062	76
191907	804062	76
191908	804062	76
191909	804062	76
191910	804062	76
191915	804092	56
191916	804092	56
191938	809001	121
191950	804070	77
191951	804070	77
191952	804070	77
191953	804070	77
191954	804070	77
191955	804070	77
191956	804070	77
191957	804070	77
191958	804070	77
191959	804070	77
191962	804085	59
191963	804085	59
191964	804085	59
191965	804085	59
191966	804085	59
191967	804085	59
191968	804085	59

Cargo	Assortments	Page
191969	804085	59
191970	804076	70
or	804098	68
191971	804076	70
191972	804076	70
191973	804076	70
191974	804076	70
191975	804076	70
191976	804076	70
191977	804076	70
191978	804076	70
191985	804092	56
191986	804092	56
192007	804073	58
192008	804073	58
192016	804084	75
192017	804084	75
192018	804084	75
192019	804084	75
192020	804084	75
192021	804084	75
192022	804084	75
192023	804084	75
192024	804084	75
192025	804084	75
192026	804084	75
192027	804084	75
192028	804084	75
192029	804084	75
192030	804084	75
192031	804084	75
192032	804084	75
192033	804084	75
192034	804084	75
192035	804084	75
192047	804085	59
192049	804086	71
192050	804086	71
192051	804086	71
192052	804086	71
192053	804086	71
192055	804086	71
192069	804077	75
192074	804074	64
192075	804074	64
192076	804074	64
192077	804075	60
192078	804075	60
192079	804075	60
192081	804075	60
192082	804075	60
192083	804075	60
192084	804075	60
192085	804075	60
192086	804075	60
192087	804075	60
192088	804075	60
192089	804075	60
192090	804075	60
or	804103	57
192091	804075	60
192113	804079	80
192114	804079	80
192115	804079	80
192116	804079	80
192117	804079	80
192118	804079	80
192119	804079	80
192120	804079	80

Index for Assortments

Cargo	Assortments	Page
192121	804079	80
192122	804079	80
192123	804079	80
192140	804103	57
192146	804080	61
192147	804081	61
192148	804081	61
192149	804080	61
192150	804080	61
192151	804080	61
192152	804081	61
192153	804081	61
192154	804080	61
192155	804080	61
or	804103	57
192156	804081	61
or	804103	57
192157	804081	61
or	804103	57
192166	804080	61
192167	804081	61
192168	804081	61
192169	804081	61
192170	804081	61
192171	804081	61
192172	804081	61
192173	804081	61
192174	804080	61
or	804103	57
192175	804081	61
or	804103	57
192176	804081	61
or	804103	57
192177	804081	61
192178	804081	61
192180	804017	51
192181	804017	51
192217	804103	57
192229	804086	71
192230	804086	71
192231	804086	71
192232	804074	64
192233	804074	64
192234	804074	64
192239	804103	57
192240	804103	57
192305	804090	72
192306	804090	72
192307	804090	72
192308	804090	72
192309	804090	72
192310	804090	72
192311	804090	72
192312	804090	72
192313	804090	72
192314	804090	72
192315	804090	72
192316	804090	72
192325	804102	72
192326	804102	73
192327	804102	73
192328	804102	73
192329	804102	73
192330	804102	73
192331	804102	73
192332	804102	73
192333	804102	73
192334	804102	73
192335	804102	73

Cargo	Assortments	Page
192336	804102	73
192337	804102	73
192344	804090	72
or	804102	73
192355	804091	65
192356	804091	65
192357	804091	65
192358	804091	65
192359	804091	65
192360	804091	65
192373	804103	57
192374	804103	57
192410	804103	57
192411	804103	57
192427	804094	71
192428	804094	71
192429	804094	71
192430	804094	71
192431	804094	71
192432	804094	71
192433	804094	71
192434	804094	71
192435	804094	71
192436	804094	71
192450	804100	60
192451	804100	60
192452	804100	60
192453	804100	60
192457	804100	60
192458	804100	60
192459	804100	60
192460	804100	60
192461	804100	60
192462	804100	60
192463	804100	60
192464	804100	60
192465	804100	60
192466	804100	60
192467	804100	60
192468	804100	60
192469	804100	60
192470	804100	60
192471	804100	60
192472	804100	60
192473	804100	60
192474	804100	60
192475	804100	60
192476	804100	60
192477	804100	60
192478	804100	60
192479	804108	65
192480	804108	65
192481	804108	65
192482	804108	65
192483	804108	65
192538	804104	72
192539	804104	72
192540	804104	72
192541	804104	72
192542	804104	72
192543	804104	72
192544	804104	72
192545	804104	72
192546	804104	72
192547	804104	72
192548	804104	72
192549	804104	72
192587	804075	60
192595	804107	62

Cargo	Assortments	Page
192596	804107	62
192597	804107	62
or	804107	62
192598	804107	62
or	804107	62
192599	804107	62
192600	804107	62
192604	804107	62
192605	804107	62
192606	804107	62
192607	804107	62
192608	804107	62
192609	804107	62
192610	804107	62
192611	804107	62
192612	804107	62
192613	804107	62
192614	804107	62
192615	804107	62
192616	804107	62
192617	804107	62
192618	804107	62
192619	804107	62
192620	804107	62
192631	814105	74
192632	814105	74
192633	814105	74
192634	814105	74
192635	814105	74
192636	814105	74
192637	814105	74
192638	814105	74
192639	814105	74
192647	814105	74
200663		5
200664		5
200665		5
200666		5
200667		5
200668		5
200669		5
200670		5
200671		5
200672		5
200673		5
200676		5
200691	808007	114
200693		5
200743	804088	85
200772	804088	85
200773	804088	85
200774	804088	85
200775	804088	85
200776	804088	85
200777	804088	85
200778	804088	85
200779	804088	85
200791	804088	85
200792	804088	85
200802	804088	85
210121	804093	54
210141	210574	86
210142	210574	86
210143	210574	86
210144	210574	86
210145	210574	86
210146	210574	86
210147	210574	86
210148	210574	86

Index for Assortments

Cargo	Assortments	Page
210149	210574	86
210150	210574	86
210151	210574	86
210152	210574	86
210153	210574	86
210154	210574	86
210155	210574	86
210156	210574	86
210157	210574	86
210158	210574	86
210159	210574	86
210160	210574	86
210164	210574	86
210639	804017	51
210643	804017	51
210644	804017	51
210645	804017	51
210708	804072	85
210709	804072	85
210710	804072	85
210712	804072	85
210713	804072	85
210715	804072	85
210716	804072	85
210718	804072	85
210720	804072	85
210722	804072	85
210723	804072	85
210724	804072	85
210725	804072	85
210726	804072	85
210727	804072	85
210729	804072	85
210740	804072	85
210741	804072	85
210742	804072	85
210743	804072	85
210744	804072	85
210745	804072	85
210747	804072	85
210748	804072	85
210750	804072	85
210751	804072	85
210752	804072	85
210753	804072	85
210754	804072	85
210757	804072	85
210759	804072	85
210762	808007	114
210763	808007	114
210841	804096	67
210842	804099	69
or	804106	68
210859	804079	80
210860	804079	80
211027	815028	152
211028	815028	152
or	815031	154
230083	802033	8
230292	802033	8
230293	802033	8
230721	803031	40
or	804029	80
232778	802008	13
233541	803028	38
233545	803039	46
233867	803028	38
or	803041	45
233868	803028	38

Cargo	Assortments	Page
or	803041	45
240442	815008	142
250002	815003	140
or	815008	142
or	815012	144
or	815019	148
or	815025	151
or	815027	152
or	815031	154
250007	815032	154
250008	815032	154
250043	815032	154
250044	815032	154
250057	815032	154
250085	815029	153
or	815032	154
250086	815002	139
or	815004	140
or	815012	144
or	815020	148
or	815021	149
250087	815023	150
or	815026	151
or	815030	153
250096	815032	154
250097	815032	154
250134	815001	139
or	815002	139
or	815004	140
or	815007	142
or	815009	143
or	815010	143
or	815011	144
or	815013	145
or	815015	146
or	815019	148
or	815020	148
or	815024	150
or	815026	151
or	815030	153
250152	815001	139
or	815003	140
or	815005	141
or	815008	142
or	815009	143
or	815010	143
or	815013	145
or	815017	147
or	815019	148
or	815023	150
or	815026	151
or	815030	153
250181	815001	139
or	815002	139
or	815003	140
or	815004	140
or	815005	141
or	815007	142
or	815012	144
or	815015	146
or	815017	147
or	815020	148
or	815028	152
or	815033	155
250191	815012	144
or	815025	151
250345	815001	139
or	815002	139
or	815003	140

Cargo	Assortments	Page
or	815004	140
or	815005	141
or	815006	141
or	815007	142
or	815008	142
or	815009	143
or	815010	143
or	815011	144
or	815012	144
or	815013	145
or	815014	145
or	815015	146
or	815016	146
or	815017	147
or	815018	147
or	815019	148
or	815020	148
or	815021	149
or	815022	149
or	815023	150
or	815024	150
or	815025	151
or	815026	151
or	815027	152
or	815030	153
250438	815005	141
or	815008	142
or	815010	143
or	815013	145
or	815017	147
or	815018	147
or	815019	148
or	815021	149
250439	815001	139
or	815002	139
or	815004	140
or	815005	141
or	815006	141
or	815008	142
or	815009	143
or	815010	143
or	815011	144
or	815013	145
or	815016	146
or	815017	147
or	815018	147
or	815019	148
or	815020	148
or	815021	149
or	815026	151
or	815030	153
250440	815001	139
or	815002	139
or	815003	140
or	815004	140
or	815005	141
or	815006	141
or	815009	143
or	815010	143
or	815011	144
or	815012	144
or	815013	145
or	815014	145
or	815016	146
or	815017	147
or	815018	147
or	815019	148
or	815020	148
or	815021	149

Index for Assortments

Cargo	Assortments	Page
or.....	815026	151
or.....	815030	153
250441	815001	139
or.....	815002	139
or.....	815003	140
or.....	815004	140
or.....	815005	141
or.....	815006	141
or.....	815009	143
or.....	815010	143
or.....	815011	144
or.....	815012	144
or.....	815013	145
or.....	815014	145
or.....	815016	146
or.....	815017	147
or.....	815018	147
or.....	815019	148
or.....	815022	149
or.....	815026	151
or.....	815030	153
250442	815001	139
or.....	815002	139
or.....	815003	140
or.....	815004	140
or.....	815005	141
or.....	815006	141
or.....	815009	143
or.....	815010	143
or.....	815011	144
or.....	815012	144
or.....	815013	145
or.....	815014	145
or.....	815016	146
or.....	815017	147
or.....	815018	147
or.....	815019	148
or.....	815022	149
or.....	815026	151
or.....	815030	153
250443	815001	139
or.....	815002	139
or.....	815003	140
or.....	815004	140
or.....	815005	141
or.....	815006	141
or.....	815007	142
or.....	815008	142
or.....	815009	143
or.....	815010	143
or.....	815011	144
or.....	815012	144
or.....	815013	145
or.....	815014	145
or.....	815016	146
or.....	815017	147
or.....	815018	147
or.....	815019	148
or.....	815023	150
or.....	815026	151
or.....	815030	153
250444	815002	139
or.....	815005	141
or.....	815006	141
or.....	815009	143
or.....	815010	143
or.....	815021	149
250445	815002	139
or.....	815014	145

Cargo	Assortments	Page
or.....	815022	149
250446	815002	139
or.....	815023	150
250447	815002	139
or.....	815014	145
or.....	815023	150
or.....	815030	153
250448	815002	139
or.....	815012	144
or.....	815023	150
250449	815002	139
250450	815002	139
or.....	815003	140
or.....	815015	146
or.....	815024	150
250452	815001	139
or.....	815006	141
or.....	815013	145
or.....	815014	145
or.....	815017	147
or.....	815021	149
250453	815001	139
or.....	815003	140
or.....	815005	141
or.....	815006	141
or.....	815008	142
or.....	815009	143
or.....	815011	144
or.....	815013	145
or.....	815016	146
or.....	815017	147
or.....	815022	149
or.....	815026	151
or.....	815030	153
250454	815001	139
or.....	815005	141
or.....	815006	141
or.....	815014	145
or.....	815021	149
250455	815001	139
or.....	815021	149
250456	815001	139
or.....	815006	141
or.....	815016	146
or.....	815021	149
250457	815001	139
or.....	815013	145
or.....	815016	146
or.....	815023	150
or.....	815026	151
250459	815001	139
or.....	815008	142
or.....	815009	143
or.....	815010	143
or.....	815012	144
or.....	815013	145
or.....	815015	146
or.....	815017	147
or.....	815019	148
or.....	815023	150
or.....	815026	151
or.....	815030	153
250460	815003	140
or.....	815010	143
or.....	815013	145
or.....	815017	147
or.....	815018	147
or.....	815024	150
250461	815003	140

Cargo	Assortments	Page
or.....	815019	148
or.....	815022	149
250462	815003	140
or.....	815006	141
or.....	815016	146
or.....	815020	148
or.....	815023	150
or.....	815026	151
250463	815003	140
or.....	815008	142
or.....	815013	145
or.....	815014	145
or.....	815016	146
or.....	815023	150
250464	815006	141
or.....	815010	143
or.....	815021	149
or.....	815026	151
250465	815006	141
or.....	815010	143
or.....	815016	146
or.....	815022	149
or.....	815026	151
250466	815006	141
or.....	815022	149
250467	815005	141
or.....	815006	141
or.....	815009	143
or.....	815010	143
or.....	815013	145
or.....	815022	149
or.....	815026	151
250468	815006	141
or.....	815009	143
or.....	815010	143
or.....	815023	150
or.....	815026	151
250469	815006	141
or.....	815009	143
or.....	815010	143
or.....	815024	150
250470	815006	141
or.....	815008	142
or.....	815010	143
or.....	815015	146
or.....	815024	150
or.....	815026	151
250471	815008	142
or.....	815019	148
or.....	815021	149
250472	815007	142
or.....	815023	150
250473	815008	142
or.....	815010	143
or.....	815016	146
or.....	815019	148
or.....	815021	149
250474	815005	141
or.....	815008	142
or.....	815009	143
or.....	815010	143
or.....	815015	146
or.....	815017	147
or.....	815023	150
or.....	815026	151
or.....	815030	153
250475	815008	142
or.....	815019	148
250476	815018	147

Index for Assortments

Cargo	Assortments	Page
or.....	815019	148
or.....	815022	149
250477	815005	141
or.....	815008	142
or.....	815010	143
or.....	815023	150
or.....	815026	151
250478	815011	144
or.....	815012	144
or.....	815015	146
or.....	815024	150
or.....	815026	151
or.....	815030	153
250479	815013	145
or.....	815015	146
or.....	815023	150
250480	815012	144
or.....	815021	149
250481	815009	143
or.....	815023	150
or.....	815026	151
or.....	815030	153
250482	815012	144
or.....	815022	149
250483	815012	144
or.....	815022	149
250484	815008	142
or.....	815014	145
or.....	815017	147
or.....	815024	150
250485	815012	144
or.....	815015	146
or.....	815024	150
or.....	815026	151
250486	815008	142
or.....	815022	149
250487	815009	143
or.....	815014	145
or.....	815021	149
250488	815016	146
or.....	815020	148
or.....	815024	150
250489	815014	145
or.....	815021	149
250490	815016	146
or.....	815024	150
250491	815014	145
or.....	815022	149
250492	815016	146
or.....	815021	149
250493	815016	146
or.....	815024	150
250494	815014	145
or.....	815022	149
250495	815016	146
or.....	815024	150
250496	815016	146
or.....	815024	150
250497	815020	148
250498	815020	148
or.....	815023	150
250499	815020	148
250500	815014	145
or.....	815022	149
250501	815013	145
or.....	815020	148
or.....	815022	149
250502	815022	149
250503	815022	149

Cargo	Assortments	Page
250504	815023	150
250505	815015	146
or.....	815020	148
or.....	815024	150
or.....	815026	151
or.....	815030	153
250506	815024	150
250507	815021	149
250508	815011	144
or.....	815024	150
or.....	815027	152
or.....	815030	153
250509	815011	144
or.....	815024	150
or.....	815027	152
or.....	815030	153
250510	815025	151
250511	815025	151
250512	815013	145
or.....	815025	151
250513	815013	145
or.....	815025	151
250514	815003	140
or.....	815025	151
250515	815025	151
250516	815025	151
250517	815025	151
250518	815025	151
250519	815025	151
250520	815025	151
250521	815025	151
250522	815002	139
or.....	815005	141
or.....	815008	142
or.....	815009	143
or.....	815010	143
or.....	815013	145
or.....	815015	146
or.....	815017	147
or.....	815018	147
or.....	815019	148
or.....	815028	152
or.....	815033	155
250523	815001	139
or.....	815003	140
or.....	815004	140
or.....	815007	142
or.....	815012	144
or.....	815014	145
or.....	815020	148
or.....	815028	152
or.....	815033	155
250524	815002	139
or.....	815005	141
or.....	815009	143
or.....	815010	143
or.....	815013	145
or.....	815015	146
or.....	815017	147
or.....	815018	147
or.....	815019	148
or.....	815028	152
or.....	815033	155
250525	815001	139
or.....	815003	140
or.....	815004	140
or.....	815007	142
or.....	815008	142
or.....	815012	144

Cargo	Assortments	Page
or.....	815014	145
or.....	815020	148
or.....	815028	152
or.....	815033	155
250526	815002	139
or.....	815007	142
or.....	815008	142
or.....	815009	143
or.....	815010	143
or.....	815013	145
or.....	815014	145
or.....	815018	147
or.....	815019	148
250527	815002	139
or.....	815007	142
or.....	815008	142
or.....	815009	143
or.....	815010	143
or.....	815013	145
or.....	815014	145
or.....	815018	147
or.....	815019	148
250528	815001	139
or.....	815002	139
or.....	815003	140
or.....	815004	140
or.....	815005	141
or.....	815007	142
or.....	815008	142
or.....	815009	143
or.....	815010	143
or.....	815012	144
or.....	815013	145
or.....	815014	145
or.....	815015	146
or.....	815017	147
or.....	815018	147
or.....	815019	148
or.....	815020	148
or.....	815028	152
or.....	815033	155
250529	815002	139
or.....	815007	142
or.....	815008	142
or.....	815009	143
or.....	815010	143
or.....	815013	145
or.....	815014	145
or.....	815018	147
or.....	815019	148
250530	815017	147
250531	815004	140
or.....	815020	148
or.....	815028	152
250532	815015	146
250533	815020	148
250534	815020	148
250535	815020	148
250536	815007	142
or.....	815009	143
or.....	815010	143
or.....	815013	145
250537	815007	142
or.....	815010	143
250538	815007	142
or.....	815009	143
or.....	815010	143
250539	815007	142
or.....	815010	143

Index for Assortments

Cargo	Assortments	Page
250542	815012	144
or	815024	150
250543	815011	144
or	815015	146
or	815029	153
or	815031	154
250544	815011	144
or	815015	146
or	815029	153
or	815031	154
250545	815011	144
or	815015	146
or	815029	153
or	815031	154
250546	815011	144
or	815015	146
or	815029	153
or	815031	154
250547	815011	144
or	815015	146
or	815029	153
or	815031	154
250548	815011	144
or	815029	153
or	815031	154
250549	815005	141
or	815011	144
or	815029	153
or	815031	154
250550	815011	144
or	815029	153
or	815031	154
250642	815026	151
250643	815029	153
or	815032	154
250701	815020	148
250777	815032	154
250802	815021	149
251142	815032	154
251273	815029	153
or	815032	154
251438	815029	153
or	815032	154
251444	815032	154
251480	815029	153
or	815032	154
251511	815028	152
251564	815029	153
or	815026	151
252165	815026	151
252166	815027	152
or	815031	154
252167	815027	152
or	815034	155
252168	815027	152
or	815034	155
252169	815027	152
or	815034	155
252171	815027	152
or	815031	154
252172	815027	152
or	815031	154
252173	815027	152
or	815031	154
252174	815031	154
252175	815027	152
or	815032	154
252176	815027	152
252177	815027	152

Cargo	Assortments	Page
252178	815027	152
252179	815027	152
252180	815028	152
or	815033	155
252181	815028	152
or	815033	155
252182	815028	152
or	815033	155
252183	815028	152
or	815033	155
252184	815028	152
or	815033	155
252185	815028	152
or	815033	155
252186	815028	152
or	815033	155
252187	815029	153
or	815032	154
252188	815029	153
252191	815032	154
252192	815033	155
252193	815033	155
252194	815033	155
252195	815034	155
252196	815034	155
252197	815034	155
252198	815034	155
252199	815034	155
252200	815034	155
252201	815034	155
252202	815034	155
252203	815034	155
252204	815034	155
252205	815034	155
252206	815034	155
282174	815027	152
610021	802023	23
610022	802023	23
610023	802023	23
610024	802023	23
610025	802023	23
610026	802023	23
610027	802023	23
610028	802023	23
610029	802023	23
610030	802023	23
610031	802023	23
610032	802023	23
610033	802023	23
610034	802023	23
610036	802023	23
610040	802023	23
610041	802023	23
610061	802023	23
610062	802023	23
610063	802023	23
B140077P	802026	20
B140079P	802026	20
B140081P	802026	20
B140084P	802026	20
B140087P	802026	20
B140088P	802001	9
B140091P	802026	20
B140093P	802026	20
B140218P	802026	20
B140219P	802026	20
B140220P	802026	20
B140223P	802026	20
B140271P	802026	20

Cargo	Assortments	Page
or	803042	44
B140272P	802026	20
B140273P	802026	20
B140274P	802026	20
B140277P	802026	20
B140278P	802026	20
BSX1004	803017	29
BSX1024	803018	28
BSX1034	803017	29
BSX1044	803018	28
BSX116F4	803017	29
BSX124	803018	28
BSX124F4	803018	28
BSX1314	803011	30
or	803017	29
BSX1341444	803018	28
BSX1351454	803017	29
BSX1371434	803018	28
BSX1394	803018	28
BSX1404	803018	28
BSX1474	803017	29
BSX1484	803011	30
or	803017	29
BSX1494	803018	28
BSX151S4	803010	28
or	803018	28
BSX1571584	803010	28
or	803018	28
BSX1591604	803010	28
or	803018	28
BSX1751764	803010	28
or	803018	28
BSX344	803017	29
BSX754	803018	28
BSX764	803018	28
BSX934	803017	29
BSX964	803018	28
BSX97F4	803018	28
BSX98F4	803018	28
BX1822	802019	8
or	802031	18
BX1852	802019	8
or	802031	18
BX1982	802019	8
BX2022	802019	8
BX2042	802019	8
BX2132	802019	8
H106	803005	44
H26	803005	44
H54	803005	44
H56	803005	44
H5-6	803005	44
JSX134	803021	33
JSX162	803021	33
JSX184	803021	33
JSX194	803021	33
JSX2122	803021	33
JSX232428	803021	33
JSX3132	803021	33
JSX33344	803021	33
JSX35364	803021	33
JSX35374	803021	33
JSX52	803021	33
JSX94	803021	33
JX30312	802015	12
JX322	802015	12
JX422	802015	12
LASX15164	803024	35
LASX15274	803024	35

Index for Assortments

Cargo	Assortments	Page
LASX22	803024	35
LASX234	803024	35
LASX314	803024	35
LASX364	803024	35
LASX373839	803024	35
LASX40412P	803024	35
LASX43442	803024	35
LASX44452P	803024	35
LASX73421P	803024	35
LAX31322	802016	12
LAX31322	802031	18
MASX13144	803021	33
MASX15164	803021	33
MASX17184	803021	33
MASX19204	803021	33
MASX21224	803021	33
MASX23244	803021	33
MASX25264	803021	33
MASX27284	803021	33
MX12	802013	14
or	802031	18
PL5	803005	44
PSX1151162	803032	41
PSX1191202	803032	41
PSX122123124	803032	41
PSX12921P	803032	41
PSX1304	803032	41
PSX1324	803032	41
PSX1332	803032	41
PSX133K2	803032	41
PSX1361374	803032	41
PSX1381392	803032	41
PSX1401414	803032	41
PSX144145K	803032	41
PSX146147K	803032	41
PSX64702	803032	41
PSX77784	803032	41
PSX81824	803032	41
PX52542	802014	16
or	802031	18
PX582	802014	16
PX602	802014	16
RX103E2	802001	9
RX103F2	802001	9
or	802031	18
RX1084	803016	31
RX1214	803016	31
RX122H4	803016	31
RX124H6	803016	31
RX134H4	803016	31
RX604	803016	31
RX708	803016	31
RX874	803016	31
RX9212	803016	31
RX954	803016	31
SVX52	802022	16
SVX72	802013	14
or	802022	16
or	802031	18
SVX92	802022	16
SW126	803005	44
USX50512	803037	32
USX50514	803037	32
USX682	803037	32
USX73852	803037	32
USX767778	803037	32
USX91922	803037	32
USX939421	803037	32

Cargo	Assortments	Page
-------	-------------	------

Cargo	Assortments	Page
-------	-------------	------

Notes

Notes

Notes

Notes

Notes

Notes